



Our Wyzz Medical general surgery product line. A series of high quality reusable surgical instrument crafted with great care



# GENERAL SURGERY

2024

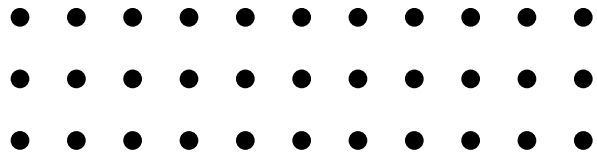
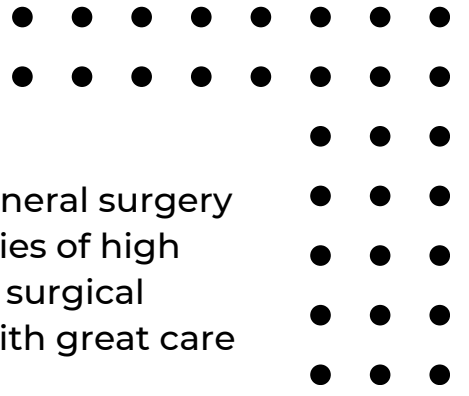

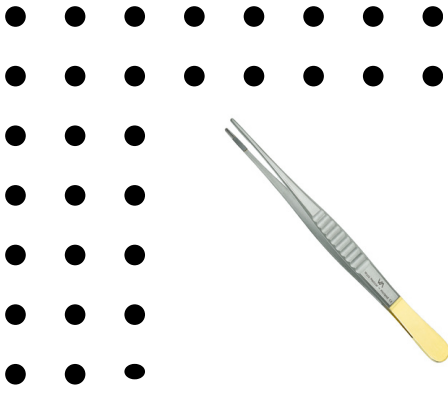

- Industrieweg 1-3, 4382 NA
- Vlissingen, The Netherlands
- info@wyzzmedical.com
- +31 85 0477700
- www.wyzzmedical.com

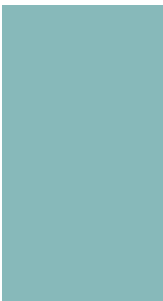
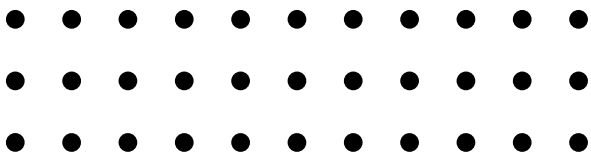



# Wyzz Medical

## INTRODUCTION

Introducing Wyzz Medical, a leading company dedicated to elevating the standards of the health sector in the Netherlands. At Wyzz Medical, we prioritize quality, service, and partnership above all else. With a focus on innovation and excellence, we specialize in providing top-tier reusable surgical instruments, meticulously crafted to meet the highest standards of safety and precision. Our commitment to sustainability extends beyond mere product quality; we offer comprehensive services and support to ensure the seamless integration of our instruments into every stage of the surgical process. From initial consultation to ongoing maintenance, Wyzz Medical is your trusted partner, dedicated to optimizing efficiency and delivering exceptional outcomes. Join us in shaping the future of healthcare with Wyzz Medical – where quality, service, and partnership converge to redefine industry standards and promote sustainable practices.

As a leading provider in the health sector, we prioritize collaboration and innovation to deliver unparalleled solutions to our partners and customers. Our commitment to service begins with our distribution network, ensuring timely delivery and support to healthcare facilities across the globe. But we don't just stop at delivery; our dedicated team works hand in hand with healthcare professionals to understand their unique needs and challenges, forging partnerships that drive mutual success.

Sincerely,

**BOB VAN LAERE**

CEO





# Wyzz Medical

## THE ESSENCE OF GENERAL SURGERY

At Wyzz Medical, we redefine the standards of quality and comfort in surgical instruments. Our comprehensive range of instruments is meticulously crafted with the utmost attention to detail, utilizing premium materials and state-of-the-art manufacturing techniques. Each instrument undergoes rigorous testing to guarantee unparalleled precision and reliability, empowering surgeons to perform with confidence and accuracy. But we don't stop there; we go beyond conventional standards by redefining comfort in surgical practice. Our instruments are ergonomically designed to minimize fatigue and maximize comfort during prolonged procedures, ensuring both surgeons and patients experience unmatched comfort throughout. With Wyzz Medical, quality and comfort are not just benchmarks – they're redefined to set new industry standards and enhance the surgical experience for all.

www.wyzzmedical.com



But it's not just about performance; Wyzz Medical general surgery instruments are designed with the comfort of both surgeons and patients in mind. Ergonomically engineered handles reduce hand fatigue during long procedures, while smooth, precise movements enhance surgical outcomes and patient recovery. With our general surgery instruments, every incision is made with confidence, precision, and unparalleled comfort.

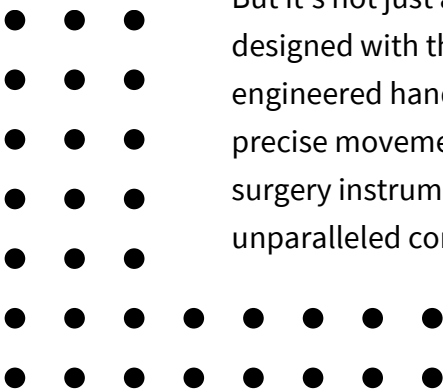



# Wyzz Medical

## PARTNERSHIP

At Wyzz Medical, research and development (R&D) are integral to our innovation mission. We invest heavily in R&D, continuously exploring new technologies and methodologies to enhance the quality and effectiveness of our products. Our focus on innovation goes hand in hand with our unwavering dedication to high quality. Every product that bears the Wyzz Medical name undergoes rigorous testing and scrutiny to ensure it meets our stringent quality standards.

But perhaps our greatest strength lies in our commitment to partnership. We believe that collaboration is key to driving meaningful change in the healthcare industry. Whether it's partnering with research institutions to pioneer new treatments or collaborating with healthcare providers to optimize surgical processes, we are dedicated to working together to improve patient outcomes and enhance the overall healthcare experience.

At Wyzz Medical, service, partnership, innovation, and quality are more than just words – they're the principles that guide everything we do. Join us in our mission to revolutionize healthcare through collaboration, innovation, and unwavering dedication to excellence.

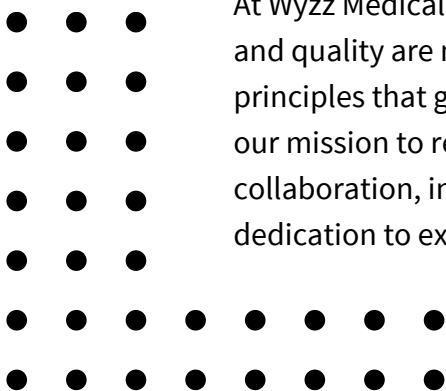

B. van Laere



H. van Maldegem



A. Tabassam

# Wyzz Medical<sup>©</sup>

WWW.WYZZMEDICAL.COM

Scissors	7-57
Needle Holders and Cases	58-81
Ligature Needles	82-83
Forceps and Clamps	84-194
Skin Hooks	195-197
Retractors	198-259
Universal Ring Retractor System	261-276
Self Retaining Retractors	278-288
Rectal Specula Instruments	289-296
Scalpel Blades and Handles	305-312
Amputation and Autopsy Instruments	313-315
Suction Instruments	316-327
Rulers, Calipers and Accessories	328-329
Metal Bowls and Cups	330

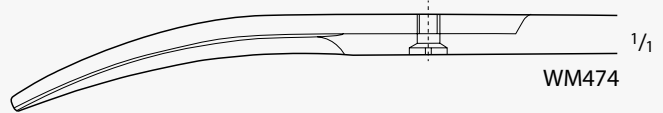
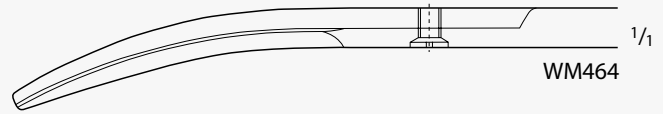
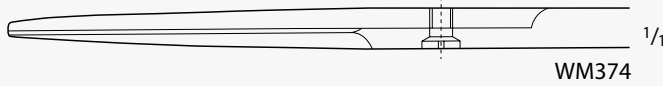

DEAVER Suture Scissors

Catalog Number	Tip	Blade	Length (in.)
WM374	S/B	STR	5 3/4
WM474	S/B	CVD	5 3/4
WM464	B/B	CVD	5 3/4

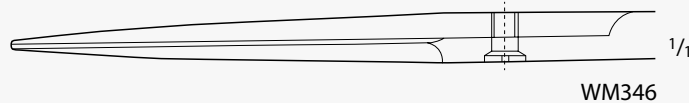
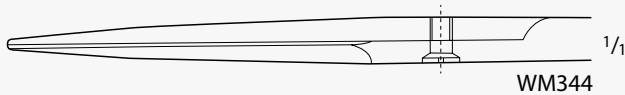
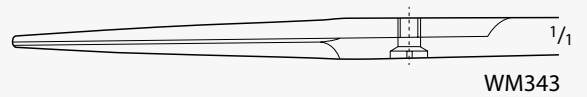
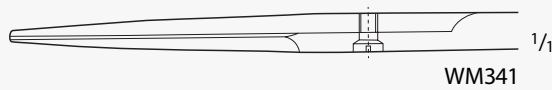
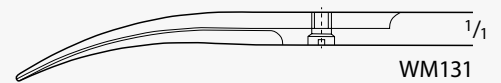
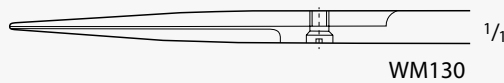
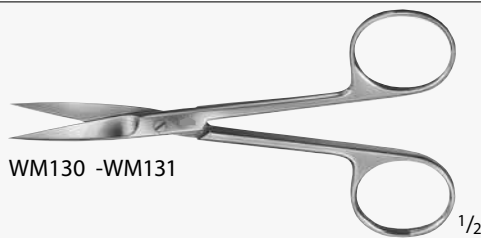

Suture Scissors

Catalog Number	Tip	Blade	Length (in.)
WM130	S/S	STR	4 3/4
WM341	S/S	STR	4 1/2
WM343	S/S	STR	5 1/8
WM344	S/S	STR	5 3/4
WM345	S/S	STR	6
WM346	S/S	STR	6 1/2
WM131	S/S	CVD	4 3/4





WM441

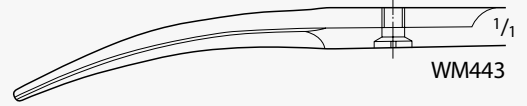

WM443



WM444



WM445



WM441 -WM445

### Suture Scissors

Catalog Number	Tip	Blade	Length (in.)
WM441	S/S	CVD	4 1/2
WM443	S/S	CVD	5 1/8
WM444	S/S	CVD	5 3/4
WM445	S/S	CVD	6



WM303C -WM304

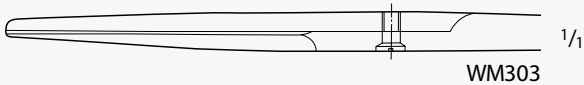

WM303

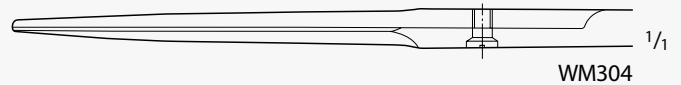

WM304

### Suture Scissors

Catalog Number	Tip	Blade	Length (in.)
WM303	S/B	DEL, STR	5 1/8
WM304	S/B	DEL, STR	5 3/4



WM496

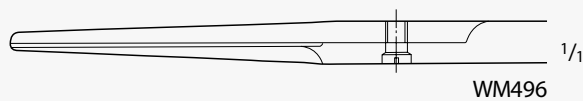

WM496

### Scissors

Catalog Number	Tip	Blade	Length (in.)
WM496	S/B	STR/1-SERR	5 1/8

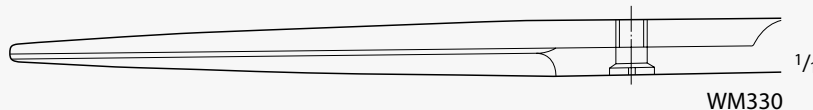
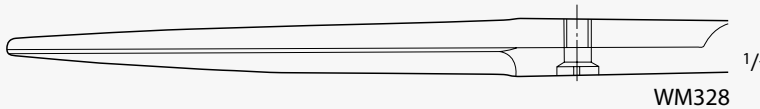
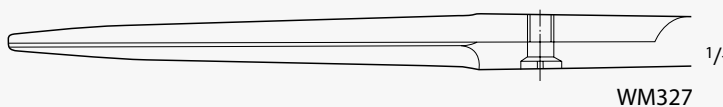
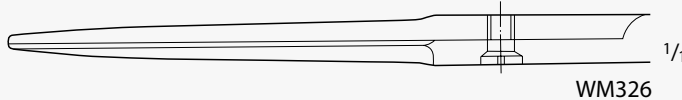
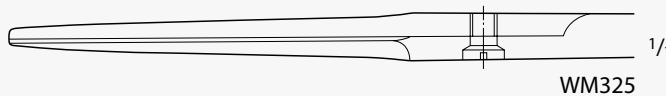
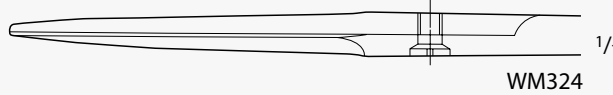
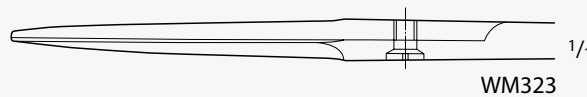
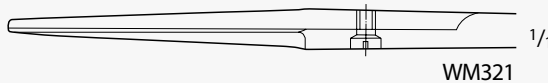
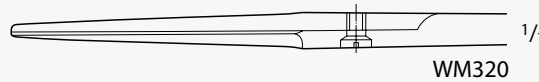
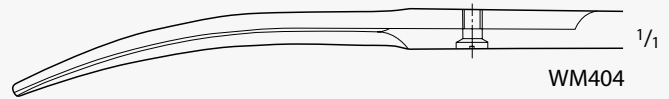
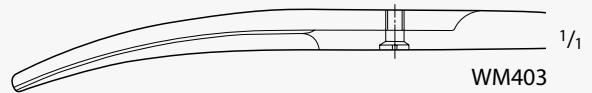

Suture Scissors

Catalog Number	Tip	Blade	Length (in.)
WM320	S/B	STR	4 1/8
WM321	S/B	STR	4 1/2
WM323	S/B	STR	5 1/8
WM324	S/B	STR	5 3/4
WM325	S/B	STR	6
WM326	S/B	STR	6 1/2
WM327	S/B	STR	6 7/8
WM328	S/B	STR	7 1/4
WM330	S/B	STR	7 7/8
WM403	S/B	CVD	5 1/8
WM404	S/B	CVD	5 3/4

INCHES



WM421



WM423



WM424

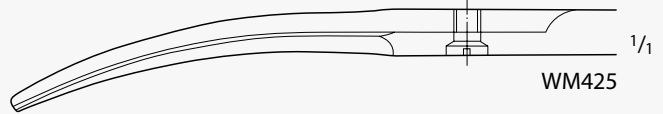

WM425

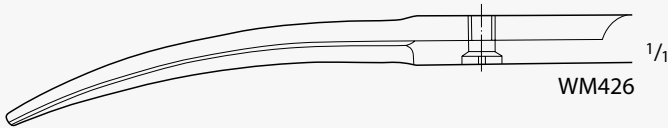

WM426

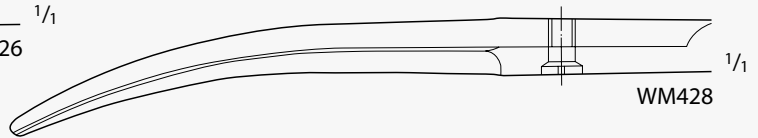

WM428



WM421 -WM428

Suture Scissors

Catalog Number	Tip	Blade	Length (in.)
WM421	S/B	CVD	4 1/2
WM423	S/B	CVD	5 1/8
WM424	S/B	CVD	5 3/4
WM425	S/B	CVD	6
WM426	S/B	CVD	6 1/2
WM428	S/B	CVD	7 1/4



WM135

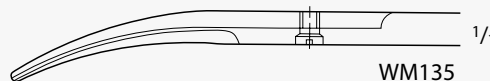

WM135

Suture Scissors

Catalog Number	Tip	Blade	Length (in.)
WM135	B/B	CVD, DEL	4 3/4



WM411 -WM417



WM411



WM413

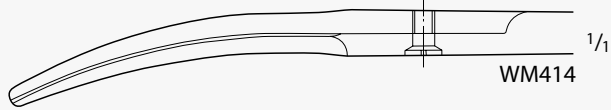

WM414



WM415

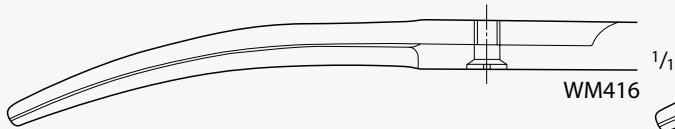

WM416

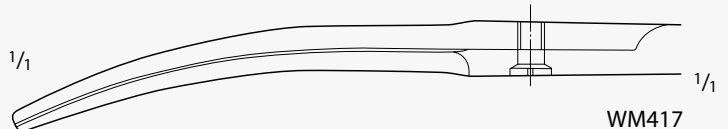

WM417



WM313 -WM317

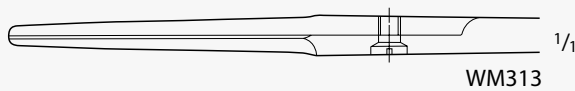

WM313

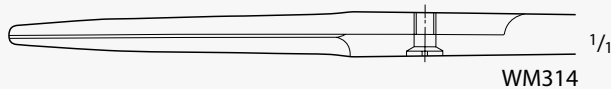

WM314



WM315

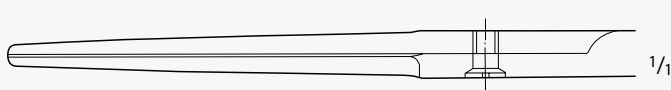

WM316

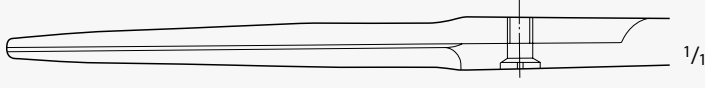

WM317

COOPER Suture Scissors

Catalog Number	Tip	Blade	Length (in.)
WM313	B/B	STR	5 1/8
WM314	B/B	STR	5 3/4
WM315	B/B	STR	6
WM316	B/B	STR	6 1/2
WM317	B/B	STR	6 7/8
WM411	B/B	CVD	4 1/2
WM413	B/B	CVD	5 1/8
WM414	B/B	CVD	5 3/4
WM415	B/B	CVD	6
WM416	B/B	CVD	6 1/2
WM417	B/B	CVD	6 7/8



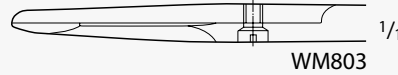

LITTAUER Ligature Scissors

Catalog Number	Tip	Blade	Length (in.)
WM803	B/1-NOTCH	STR	5 1/4

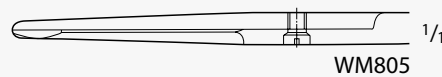

NORTHBENT Ligature Scissors

Catalog Number	Tip	Blade	Length (in.)
WM805	B/1-NOTCH	LAT-CVD	4 3/4

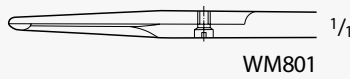

SPENCER Suture Scissors

Catalog Number	Tip	Blade	Length (in.)
WM801	B/1-NOTCH	STR	3 1/2
WM802	B/1-NOTCH	STR	4 1/2

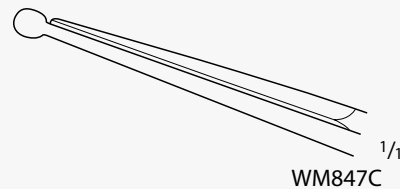
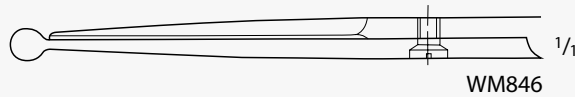

KNOWLES Bandage Scissors

Catalog Number	Tip	Blade	Length (in.)
WM846	1-PROBE POINT	STR	5 3/4
WM847	1-PROBE POINT	LAT-ANG	5 1/2

INCHES

1

2

3

4

5

6

7

8

9

10

11

12

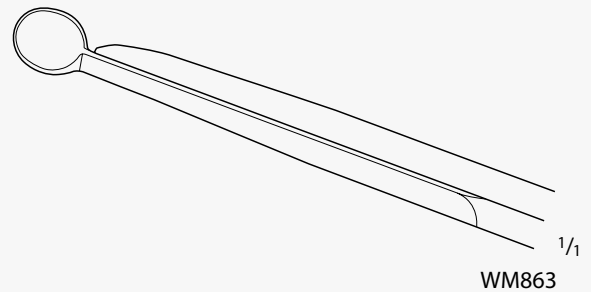
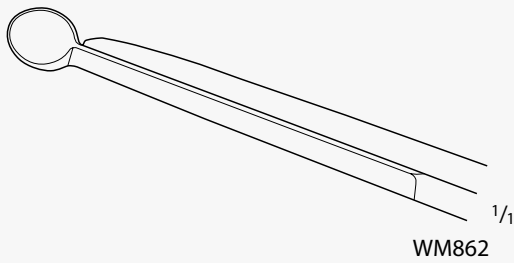
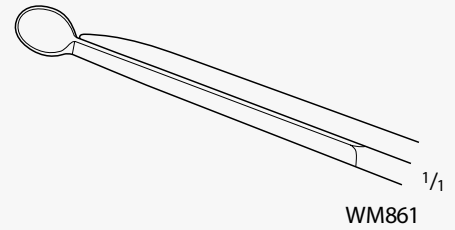
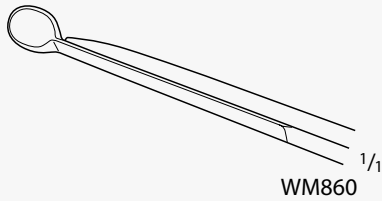
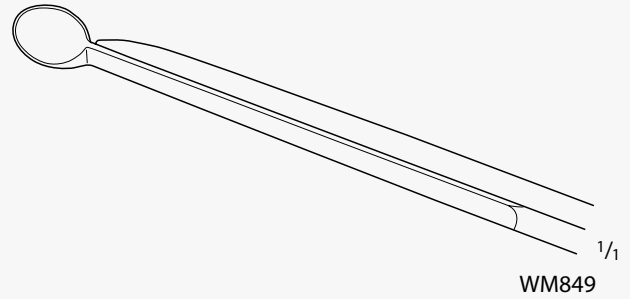
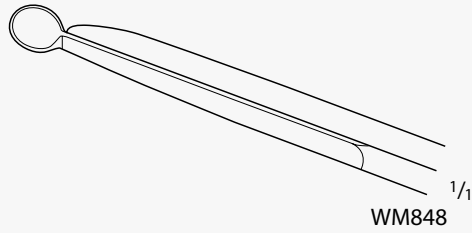

LISTER Bandage Scissors

Catalog Number	Blade	Length (in.)
WM848	LONG	6 1/8
WM849	LONG	7
WM860	STANDARD	4 1/2
WM861	STANDARD	5 1/2
WM862	STANDARD	7
WM863	STANDARD	7 7/8

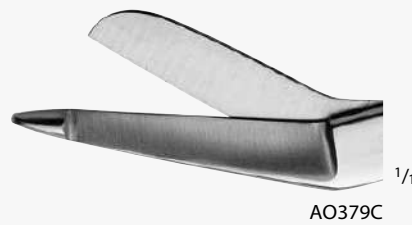

LISTER Bandage Scissors, Gold Handle

Catalog Number	Length (in.)
WM379	5 1/2



WM223



WM223

LISTER Bandage Scissors, W/ One Large Ring

Catalog Number	Length (in.)
WM223	8



WM876 , WM146

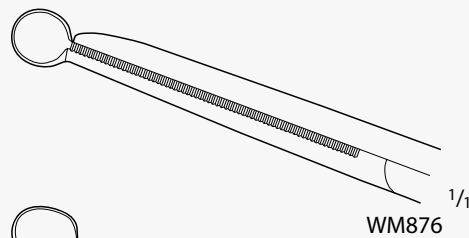

WM876

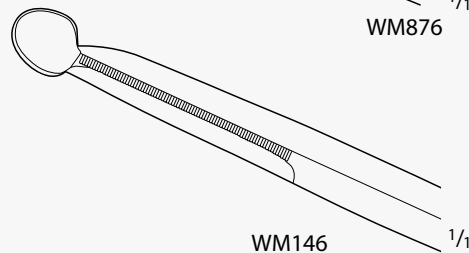

WM146

LISTER Bandage Scissors, Serrated

Catalog Number	Length (in.)
WM146	3 1/2
WM876	6 1/4



WM890

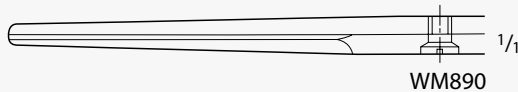

WM890

**Nurse's Bandage Scissors**

Catalog Number	Tip	Blade	Handle Color	Length (in.)
WM890	B/B	STR	RED	5 3/4



WM885 -WM979

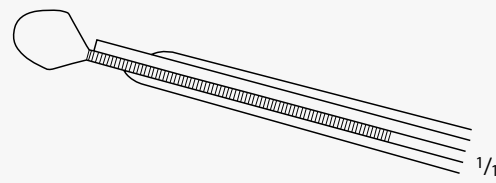

WM885 -WM979

**LISTER Universal Bandage Scissors, Serrated**

Catalog Number	Handle Color	Length (in.)
WM885	BLACK	5 3/4
WM970	RED	5 3/4
WM971	BLUE	5 3/4
WM973	YELLOW	5 3/4
WM975	ORANGE	5 3/4
WM977	PINK	5 3/4
WM978	LIGHT GREEN	5 3/4
WM979	VIOLET	5 3/4



WM881 -WM989

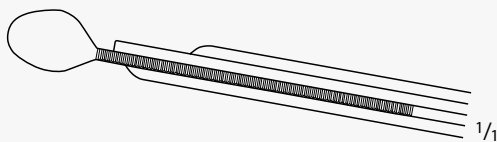

WM881 -WM989

**Universal Bandage Scissors, W/ One Large Ring, Serrated**

Catalog Number	Handle Color	Length (in.)
WM881	BLACK	7
WM980	RED	7
WM981	BLUE	7
WM983	YELLOW	7
WM985	ORANGE	7
WM987	PINK	7
WM988	LIGHT GREEN	7
WM989	VIOLET	7

INCHES

1

2

3

4

5

6

7

8

9

10

11

15

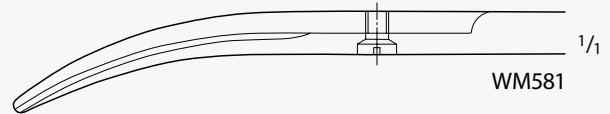
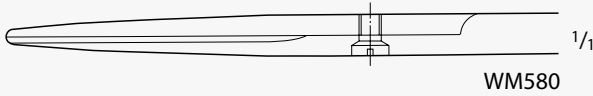

STILLE Dissecting Scissors, Round Blades

Catalog Number	Tip	Blade	Length (in.)
WM580	B/B	STR	6
WM581	B/B	CVD	6

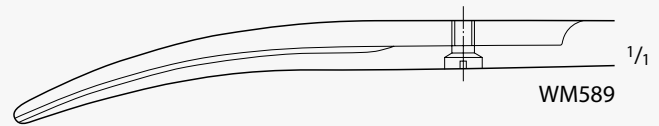
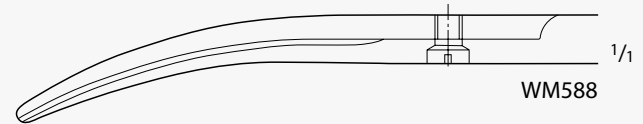
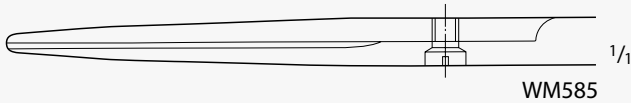
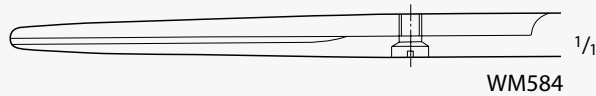

MAYO Dissecting Scissors, Round Blade

Catalog Number	Tip	Blade	Length (in.)
WM584	B/B	STR	6 1/2
WM585	B/B	STR	7 7/8
WM587	B/B	CVD	6 1/2
WM588	B/B	CVD	7 7/8
WM589	B/B	CVD	8 1/4





WM560 -WM561



WM560

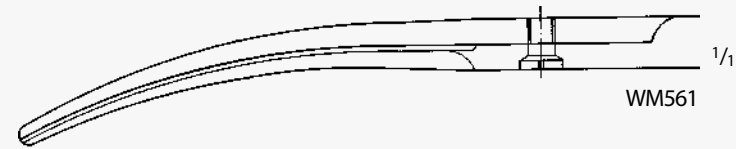

WM561

MAYO-HARRINGTON Dissecting Scissors

Catalog Number	Tip	Blade	Length (in.)
WM560	B/B	STR	9
WM561	B/B	CVD	9



WM567 -WM568

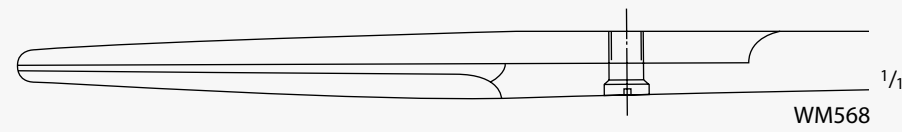

WM568

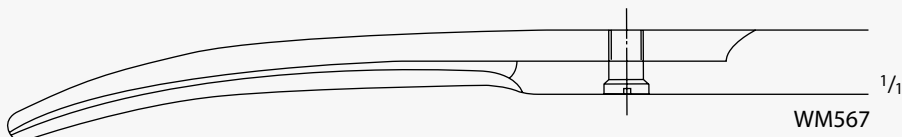

WM567

MAYO-HARRINGTON Dissecting Scissors

Catalog Number	Tip	Blade	Length (in.)
WM568	B/B	STR	11
WM567	B/B	CVD	11

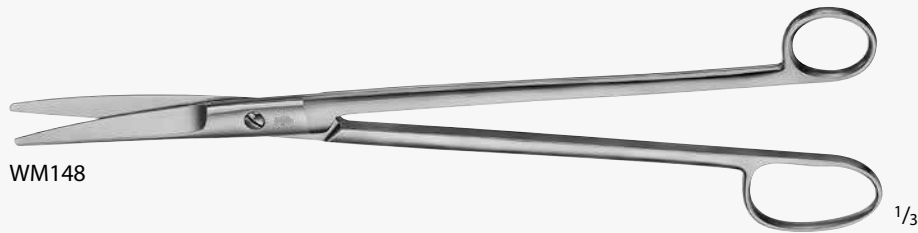

WM148



WM148

MAYO Dissecting Scissors, W/ One Large Ring

Catalog Number	Tip	Blade	Length (in.)
WM148	B/B	HEAVY	14



WM544 -WM557

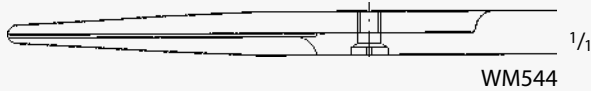

WM544

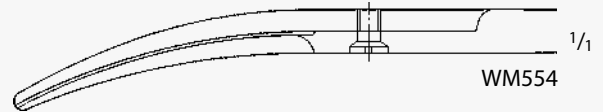

WM554

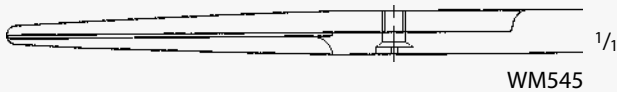

WM545



WM555

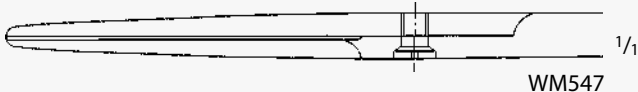

WM547



WM557



WM562 -WM565

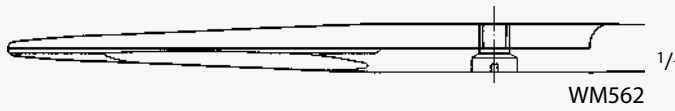

WM562

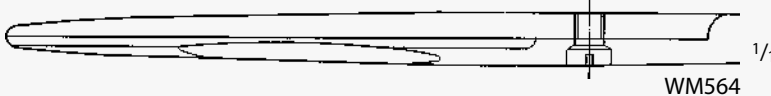

WM564

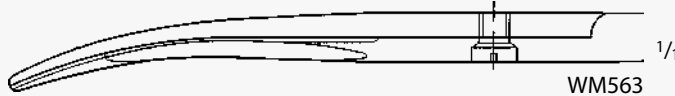

WM563

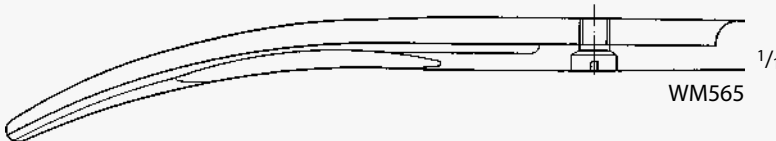

WM565

Blade MAYO Dissecting Scissors, Beveled

Catalog Number	Tip	Blade	Length (in.)
WM544	B/B	STR	5 1/2
WM545	B/B	STR	6 1/8
WM547	B/B	STR	6 3/4
WM562	B/B	STR	7 1/2
WM564	B/B	STR	8 1/2
WM554	B/B	CVD	5 1/2
WM555	B/B	CVD	6 1/8
WM557	B/B	CVD	6 3/4
WM563	B/B	CVD	7 1/2
WM565	B/B	CVD	8 1/2

INCHES





WM466 - WM467



WM466



WM467

MAYO Operating Scissors

Catalog Number	Tip	Blade	Length (in.)
WM466	S/S	STR	5 1/2
WM467	S/S	CVD	5 1/2



WM594

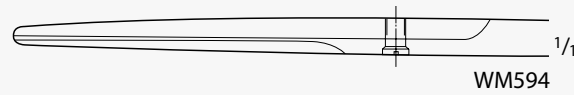

WM594

MAYO Dissecting Scissors, Delicate

Catalog Number	Tip	Blade	Length (in.)
WM594	B/B	STR	5 1/2



WM804

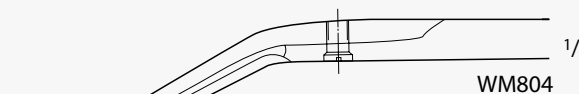

WM804

NEW'S Suture Scissors

Catalog Number	Tip	Blade	Length (in.)
WM804	B/B	ANG	5 1/2



WM806

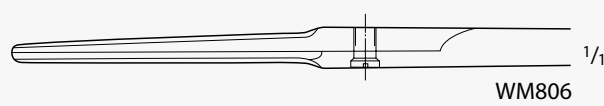

WM806

Suture Scissors

Catalog Number	Tip	Blade	Length (in.)
WM806	B/B	STR	4 1/2

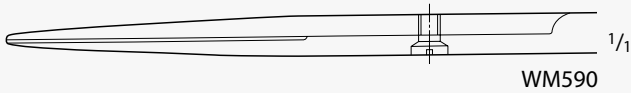

WM590

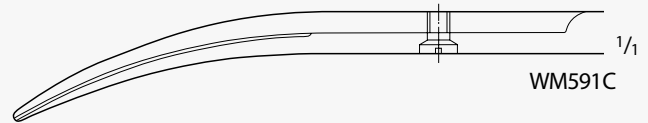

WM591C



WM590 -WM591

LEXER Dissecting Scissors, Delicate

Catalog Number	Tip	Blade	Length (in.)
WM590	B/B	STR	6 1/2
WM591	B/B	CVD	6 1/2



WM592

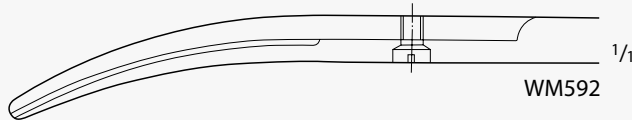

WM592

MAYO-LEXER Dissecting Scissors

Catalog Number	Tip	Blade	Length (in.)
WM592	B/B	CVD	6 1/2



WM149

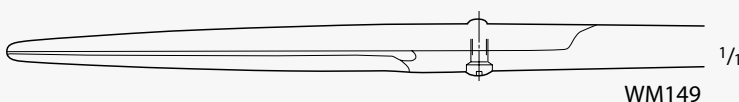

WM149

MAYO-SIMS Dissecting Scissors

Catalog Number	Tip	Blade	Length (in.)
WM149	B/B	STR	7 3/4

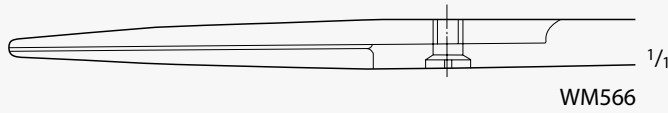

WM566

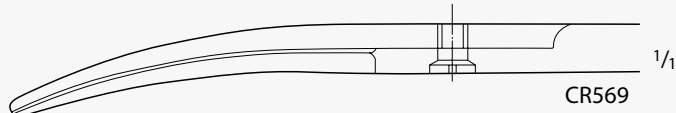

CR569



WM566 -CR569

**MAYO-NOBLE Dissecting Scissors,  
Broad Blade**

Catalog Number	Tip	Blade	Length (in.)
WM566	B/B	STR	6 3/4
WM569	B/B	CVD	6 3/4

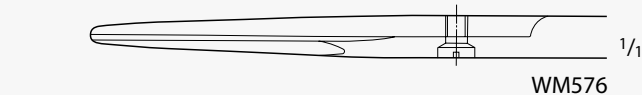

WM576

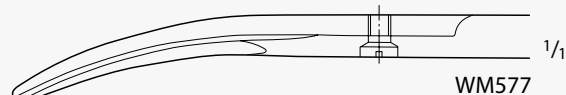

WM577

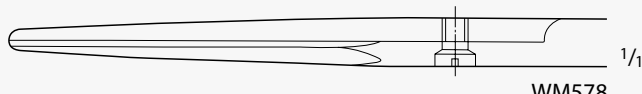

WM578

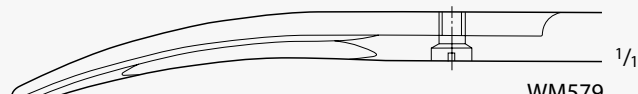

WM579



WM576C -WM579

**MAYO-STILLE Dissecting Scissors,  
Beveled Blade**

Catalog Number	Tip	Blade	Length (in.)
WM576	B/B	STR	5 1/2
WM578	B/B	STR	6 1/2
WM577	B/B	CVD	5 1/2
WM579	B/B	CVD	6 1/2

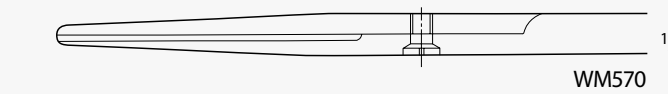

WM570

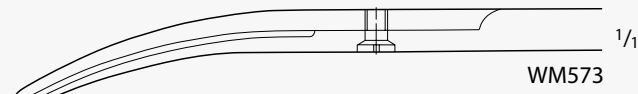

WM573

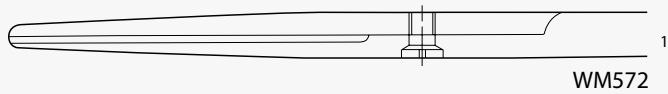

WM572

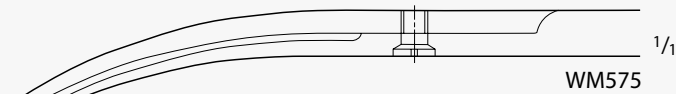

WM575



WM570 -WM575

**MAYO-STILLE Dissecting Scissors,  
Flat Blade**

Catalog Number	Tip	Blade	Length (in.)
WM570	B/B	STR	5 1/2
WM572	B/B	STR	6 3/4
WM573	B/B	CVD	5 1/2
WM575	B/B	CVD	6 3/4

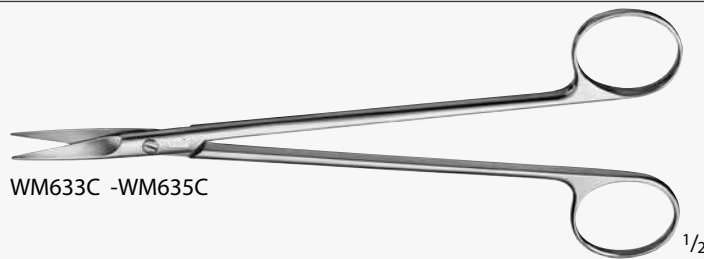

WM633C -WM635C

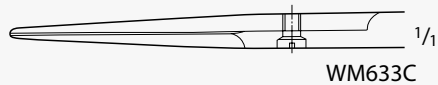

WM633C

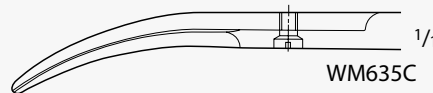

WM635C

**TOENNIS Dissecting Scissors**

Catalog Number	Tip	Blade	Length (in.)
WM633	B/B	X-DEL, STR	7
WM634	B/B	DEL, STR	7
WM635	B/B	DEL, CVD	7

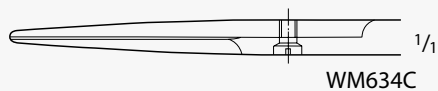

WM634C

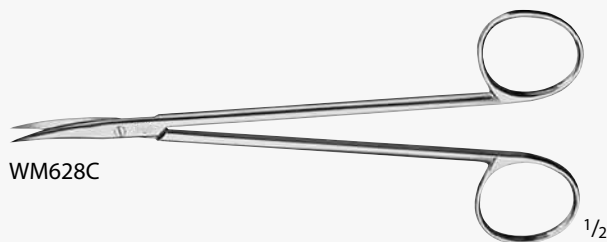

WM628C

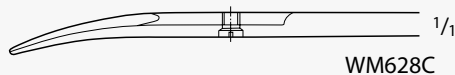

WM628C

**Nerve Dissecting Scissors**

Catalog Number	Tip	Blade	Length (in.)
WM628	S/S	CVD	6

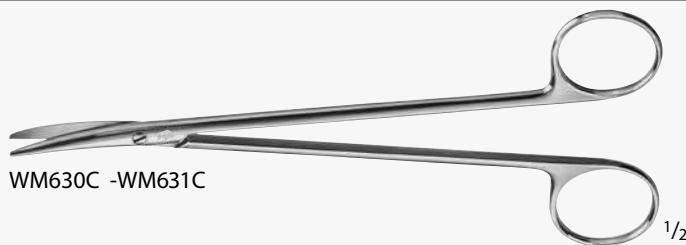

WM630C -WM631C

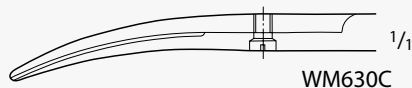

WM630C



WM631C

**TOENNIS-ADSON Dissecting Scissors**

Catalog Number	Tip	Blade	Length (in.)
WM630	X-DEL	CVD	6 7/8
WM631	DEL	CVD	6 7/8

INCHES

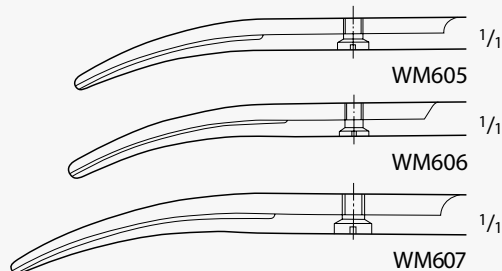
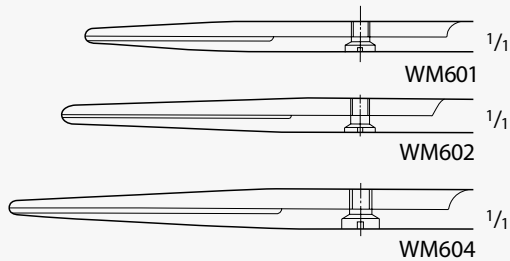

METZENBAUM Dissecting Scissors

Catalog Number	Tip	Blade	Length (in.)
WM601	B/B	STR	5 3/4
WM602	B/B	STR	7
WM604	B/B	STR	7 7/8
WM605	B/B	CVD	5 3/4
WM606	B/B	CVD	7
WM607	B/B	CVD	7 7/8

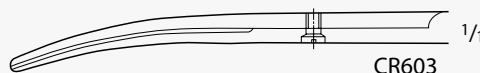
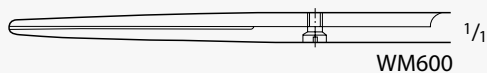

Baby METZENBAUM Dissecting Scissors, Delicate

Catalog Number	Tip	Blade	Length (in.)
WM600	B/B	STR	5 3/4
WM603	B/B	CVD	5 3/4

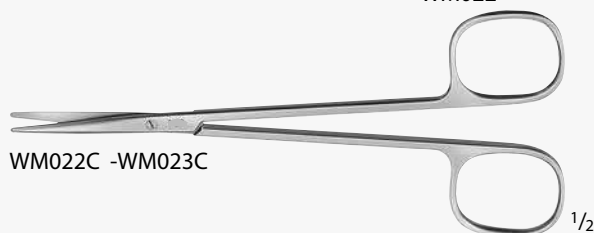
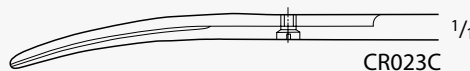
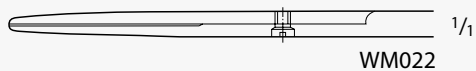

Baby METZENBAUM Dissecting Scissors

Catalog Number	Tip	Blade	Length (in.)
WM022	B/B	STR	5 3/4
WM023	B/B	CVD	5 3/4



METZENBAUM Scissors, Delicate

Catalog Number	Tip	Blade	Length (in.)
WM464	B/B	CVD	5 1/2
WM465	B/B	CVD	8

WM611 -WM619 ,WM926

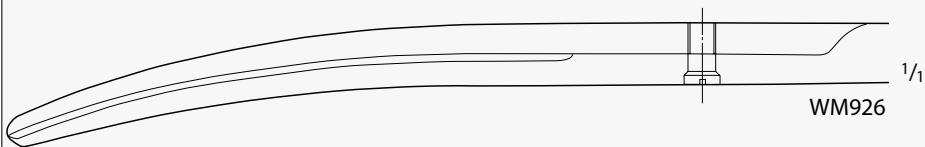
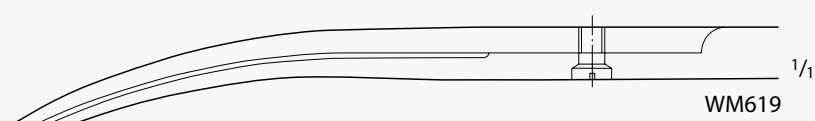
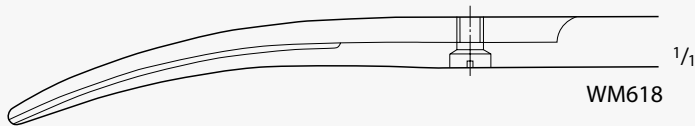
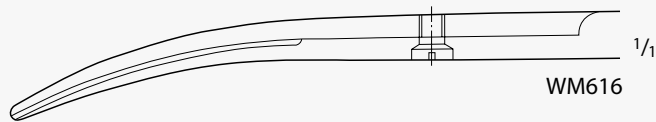
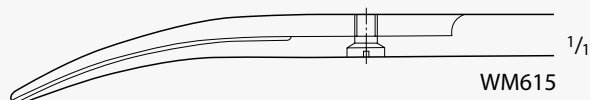
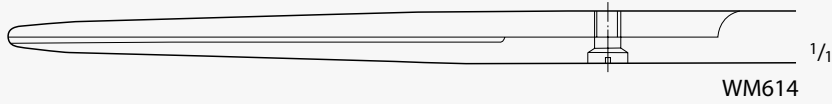
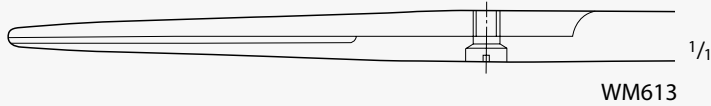
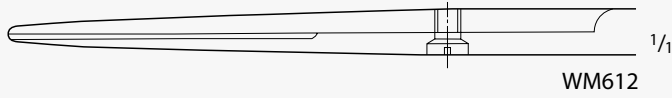
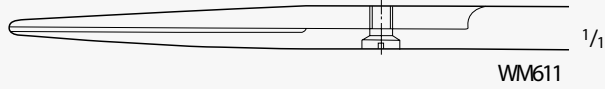
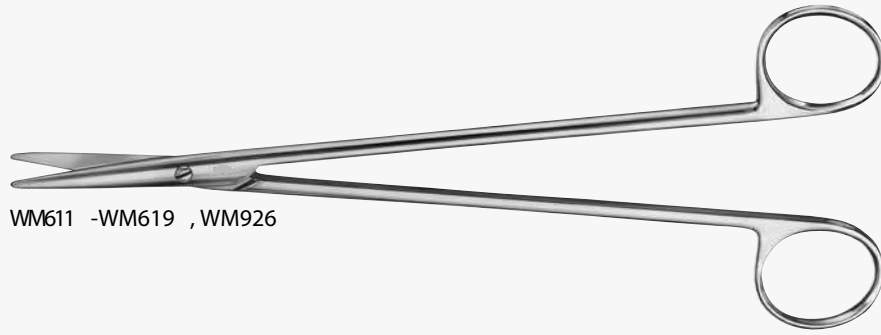

NELSON-METZENBAUM Dissecting Scissors

Catalog Number	Tip	Blade	Length (in.)
WM611	B/B	STR	9
WM 612	B/B	STR	9 3/4
WM613	B/B	STR	11 1/4
WM614	B/B	STR	12
WM615	B/B	CVD	9
WM616	B/B	CVD	9 3/4
WM618	B/B	CVD	11 1/4
WM619	B/B	CVD	12
WM926	B/B	CVD	16

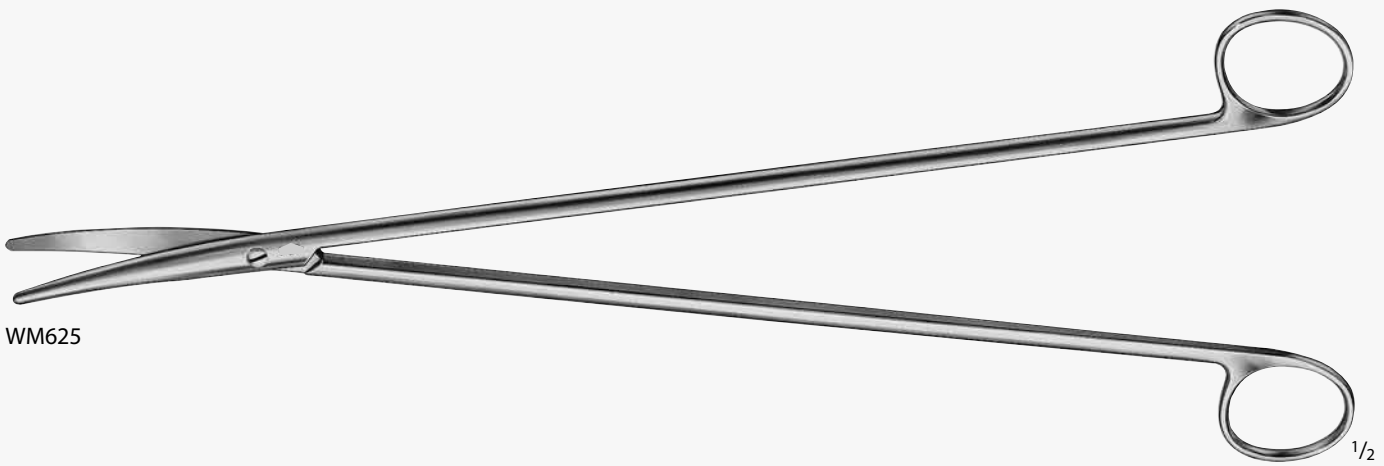

WM625

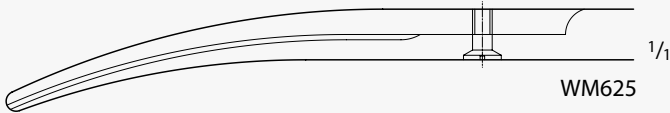

WM625

NELSON-METZENBAUM Dissecting Scissors, Delicate

Catalog Number	Tip	Blade	Length (in.)
WM625	B/B	CVD	13 3/4

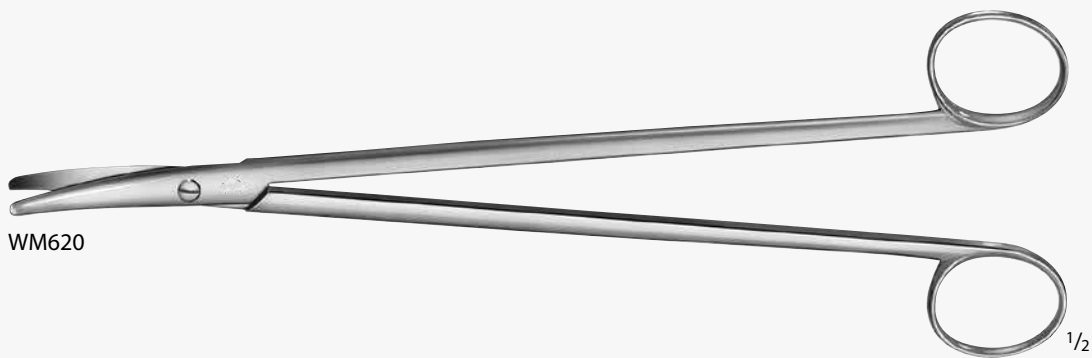

WM620

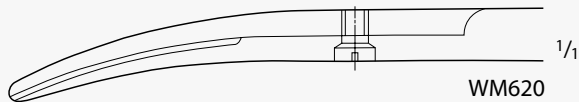

WM620

WELLER Dissecting Scissors

Catalog Number	Tip	Blade	Length (in.)
WM620	B/B	HEAVY-CVD	11



WM774

1/2

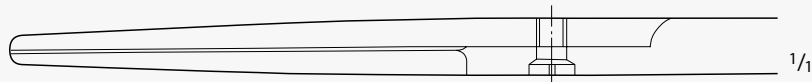

WM774

1/1

### Abdominal Scissors

Catalog Number	Tip	Blade	Length (in.)
WM774	B/B	STR	7

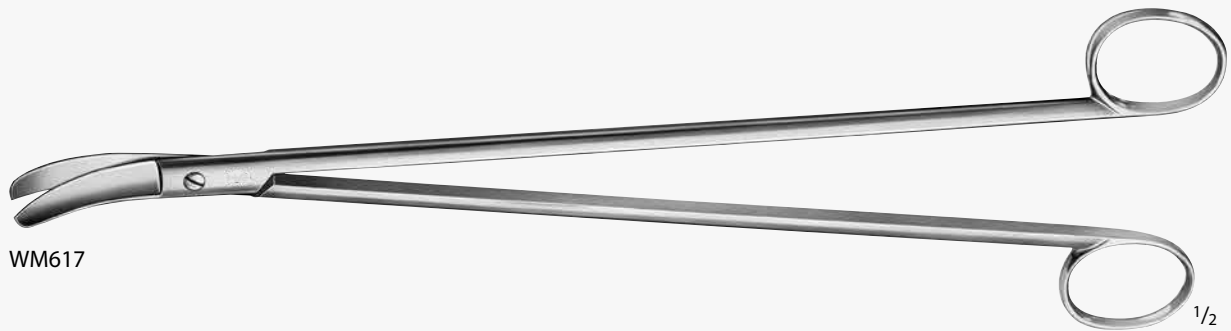

WM617

1/2

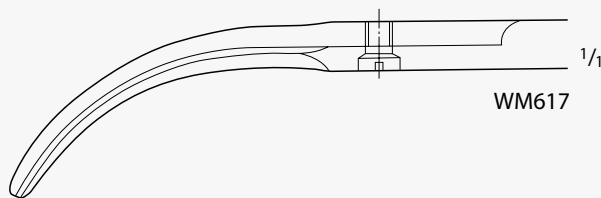

WM617

1/1

### Rectal Scissors

Catalog Number	Tip	Blade	Length (in.)
WM617	B/B	HEAVY-CVD	12 3/4

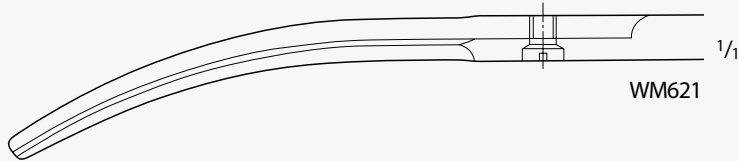

LLOYD-DAVIES Rectal Scissors

Catalog Number	Tip	Blade	Length (in.)
WM621	B/B	CVD	10 5/8

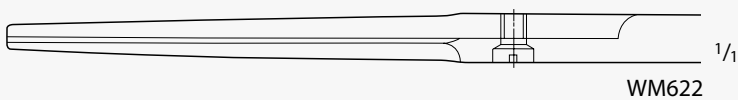
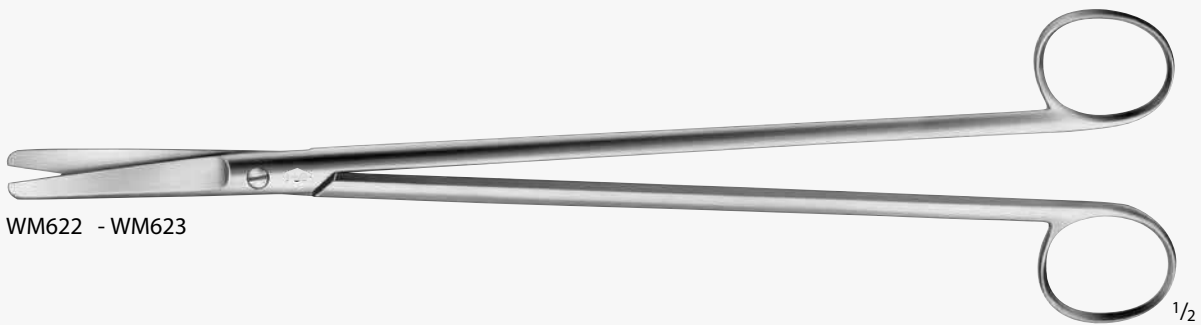

STELZNER Rectal Scissors

Catalog Number	Tip	Blade	Length (in.)
WM622	B/B	STR	12 1/4
WM623	B/B	CVD	12 1/4

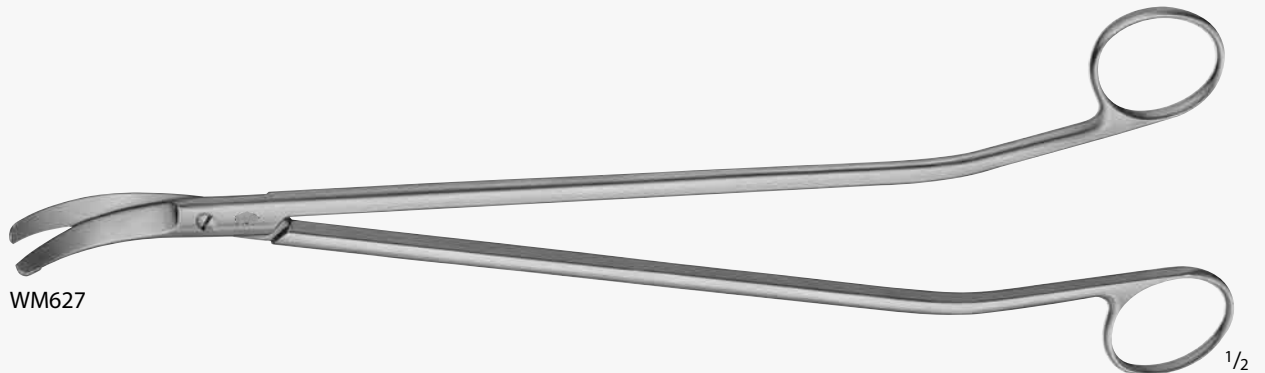

WM627

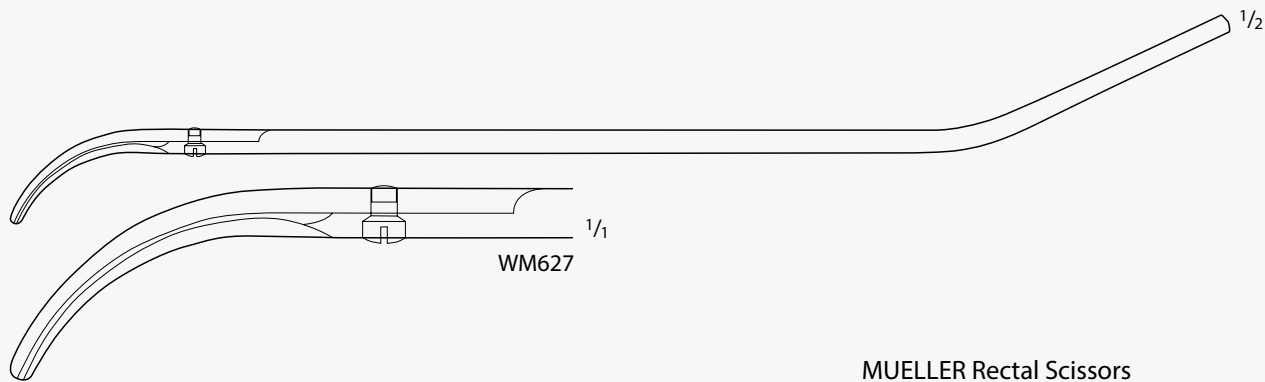

WM627

MUELLER Rectal Scissors

Catalog Number	Tip	Blade	Length (in.)
WM627	B/B	CVD	12 3/4

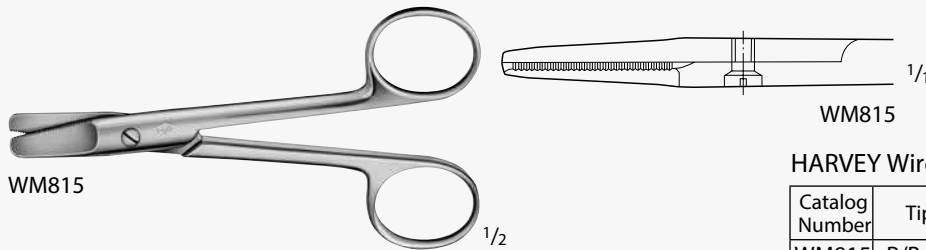

WM815

WM815

HARVEY Wire Scissors

Catalog Number	Tip	Blade	Length (in.)
WM815	B/B	SERR	5

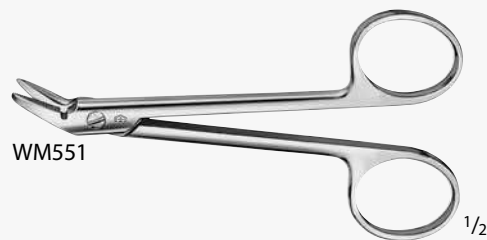

WM551

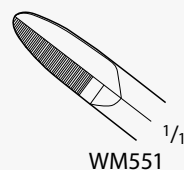

WM551

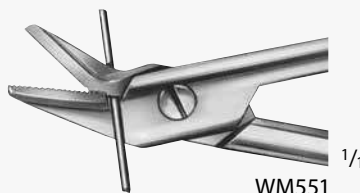

WM551

Wire Cutting Scissors

Catalog Number	For Wire Size	Length (in.)
WM551	SOFT, UP TO 1.2MM AND HARD, UP TO 0.6 MM	4 3/4



WM110 -WM117

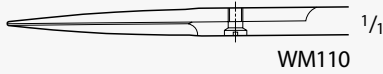

WM110

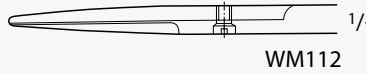

WM112

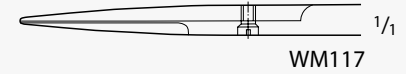

WM117

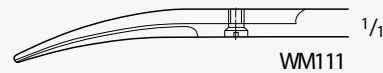

WM111

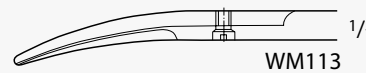

WM113



WM117



WM064 -WM065

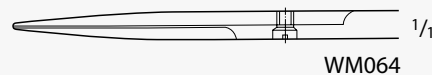

WM064

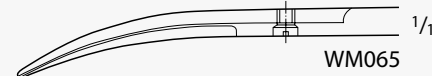

WM065



WM100 -WM101

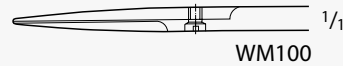

WM100

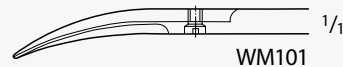

WM101

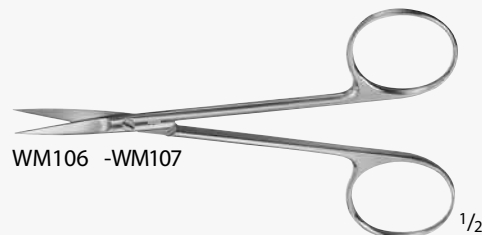

WM106 -WM107

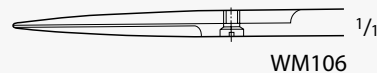

WM106

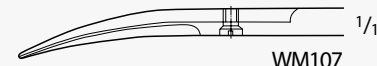

WM107

### Iris Scissors

Catalog Number	Tip	Blade	Length (in.)
WM100	S/S	STR	3 1/2
WM110	S/S	STR	4 1/4
WM106	S/S	STR	4 1/2
WM064	S/S	STR	4 3/4
WM101	S/S	CVD	3 1/2
WM111	S/S	CVD	4 1/4
WM107	S/S	CVD	4 1/2
WM065	S/S	CVD	4 3/4
WM112	S/B	STR	4 1/4
WM113	S/B	CVD	4 1/4
WM117	S/S	LAT-ANG	4 1/4

INCHES



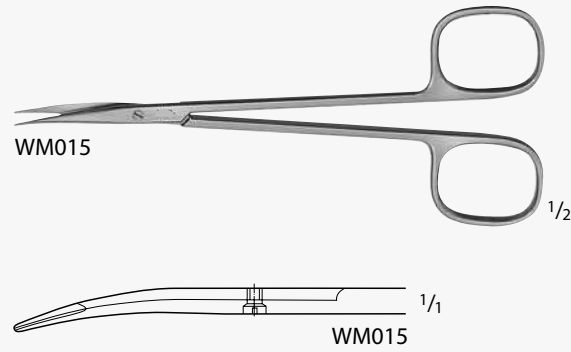

REYNOLDS-JAMESON Tenotomy Scissors

Catalog Number	Tip	Blade	Handle	Length (in.)
WM015	B/B	CVD	SQUARE	5 1/2

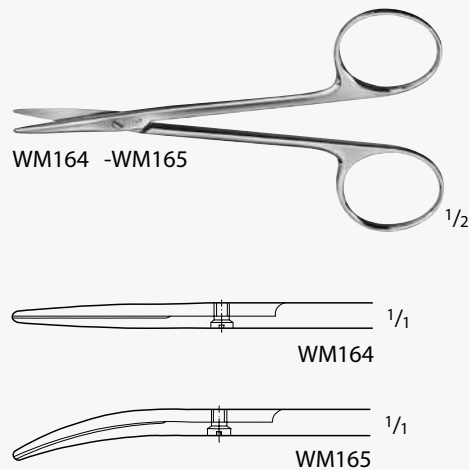

Strabismus Scissors

Catalog Number	Tip	Blade	Length (in.)
WM164	B/B	STR	4 1/2
WM165	B/B	CVD	4 1/2



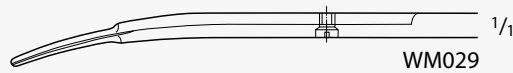
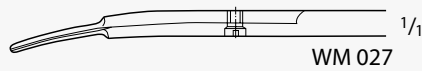
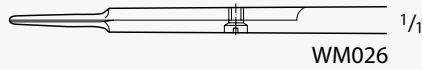
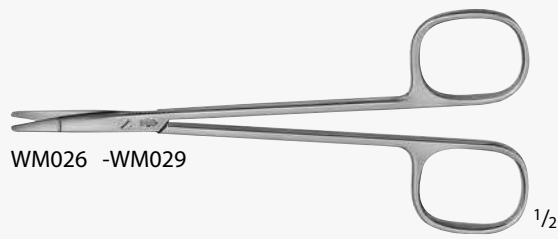

RAGNELL Dissecting Scissors

Catalog Number	Tip	Blade	Length (in.)
WM026	B/B	STR	5 1/4
WM027	B/B	CVD	5 1/4
WM029	B/B	CVD	6



WM153

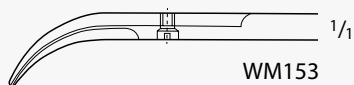

WM153

CHADWICK Scissors, Delicate

Catalog Number	Tip	Blade	Length (in.)
WM153	S/S	CVD	4 1/2



WM154

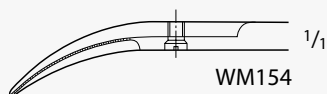

WM154

LA GRANGE Scissors

Catalog Number	Tip	Blade	Length (in.)
WM154	S/S	1-SERR	4 1/4

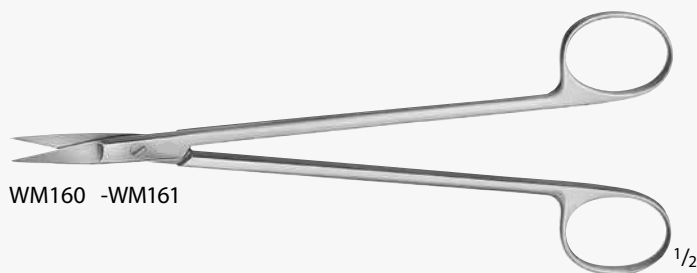

WM160 -WM161

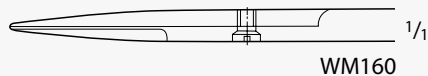

WM160

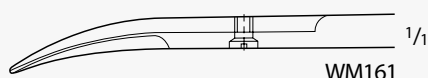

WM161

KELLY Scissors

Catalog Number	Tip	Blade	Length (in.)
WM160	S/S	STR	6 7/8
WM161	S/S	CVD	6 7/8

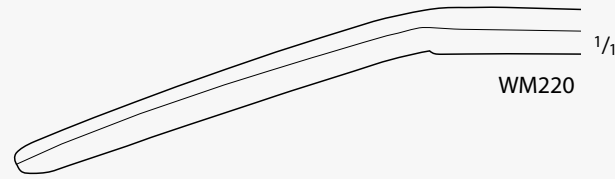

ROCHESTER-FERGUSON Scissors

Catalog Number	Tip	Blade	Length (in.)
WM220	B/B	ANG FLAT	7



DUROTIP Tungsten Carbide Scissors

- Excellent cutting accuracy
- Long working life
- Gold-plated rings

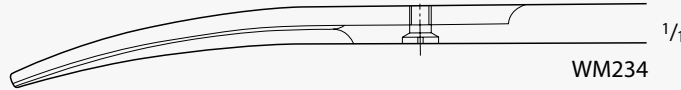
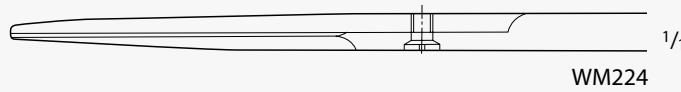
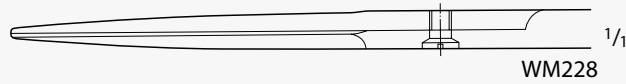

DUROTIP TC Suture Scissors

Catalog Number	Tip	Blade	Length (in.)
WM228	S/S	STR	5 3/4
WM224	S/B	STR	5 3/4
WM234	S/B	CVD	5 3/4

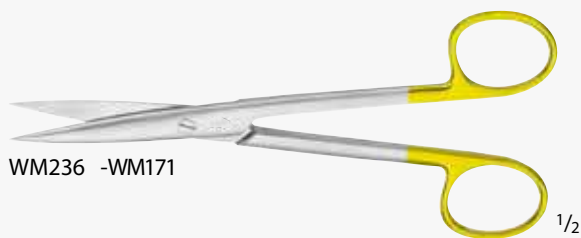
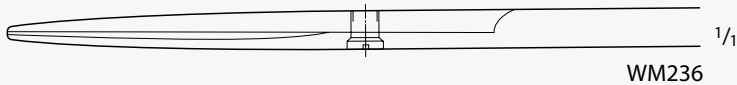

DUROTIP TC Operating Scissors

Catalog Number	Tip	Blade	Length (in.)
WM236	S/S	STR	5 3/4
WM171	S/S	CVD	5 3/4

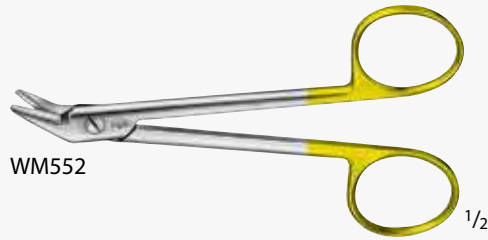

WM552

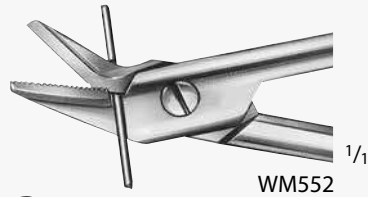

WM552

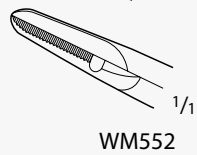

WM552

**DUROTIP TC Wire Cutting Scissors**

Catalog Number	Blade	For Wire Size	Length (in.)
WM552	1-SERR	SOFT, UP TO 1.2 MM AND HARD, UP TO 0.8 MM	4 3/4



WM284

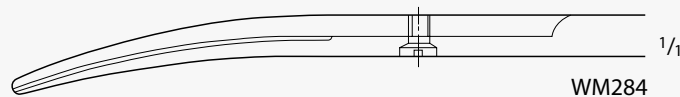

WM284

**DUROTIP TC MAYO-LEXER Dissecting Scissors, Round Blades**

Catalog Number	Tip	Blade	Length (in.)
WM284	B/B	CVD	6 1/2

INCHES

1  
2  
3  
4  
5  
6  
7  
8  
9  
10  
11



CR240C -CR243C

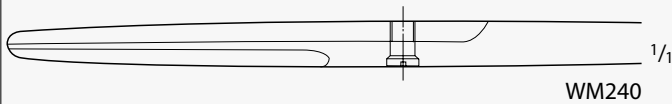

WM240

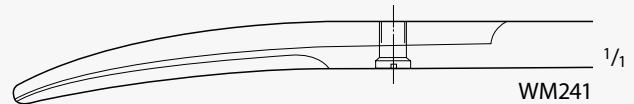

WM241

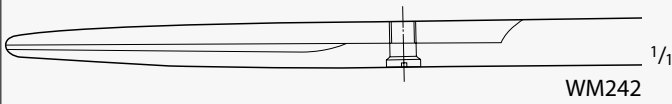

WM242



WM243

**DUROTIP TC MAYO Dissecting Scissors,  
Round Blades**

Catalog Number	Tip	Blade	Length (in.)
WM240	B/B	STR	5 1/2
WM242	B/B	STR	6 3/4
WM241	B/B	CVD	5 1/2
WM243	B/B	CVD	6 3/4



WM250 -WM253

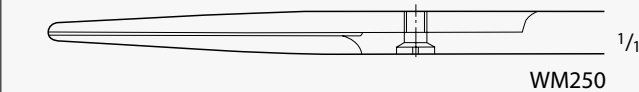

WM250

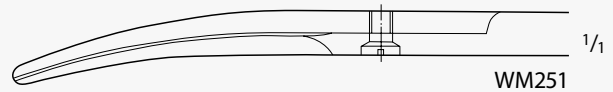

WM251

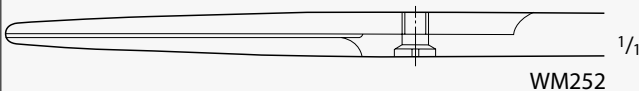

WM252

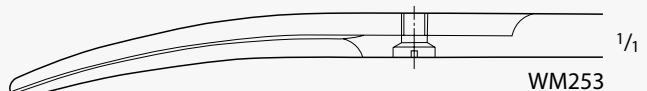

WM253

**DUROTIP TC MAYO Dissecting Scissors,  
Beveled Blades**

Catalog Number	Tip	Blade	Length (in.)
WM250	B/B	STR	5 1/2
WM252	B/B	STR	6 3/4
WM251	B/B	CVD	5 1/2
WM253	B/B	CVD	6 3/4

INCHES





WM558 -WM559 , WM726

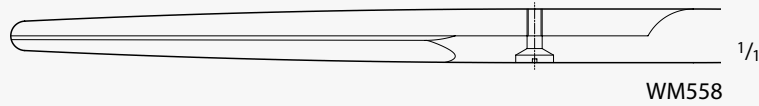

WM558



WM559

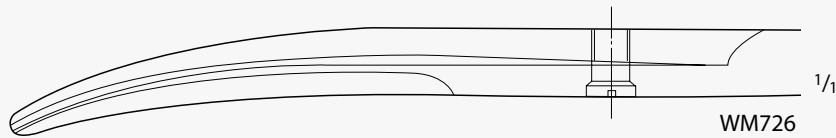

WM726



WM215

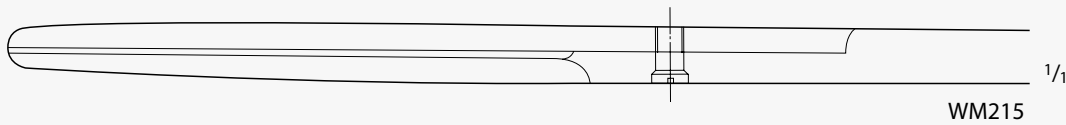

WM215



DUROTIP TC MAYO Dissecting Scissors

Catalog Number	Tip	Blade	Length (in.)
WM558	B/B	STR	9
WM215	B/B	STR	14
WM559	B/B	CVD	9
WM726	B/B	CVD	14

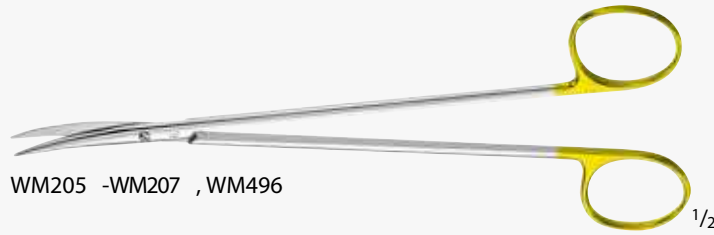

WM205 -WM207 , WM496



WM205

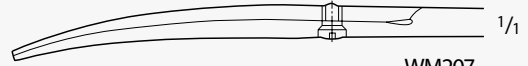

WM207



WM496

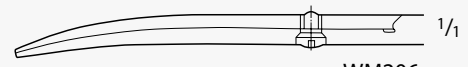

WM206

DUROTIP TC METZENBAUM Dissecting Scissors, Delicate

Catalog Number	Tip	Blade	Length (in.)
WM205	S/S	STR	9 1/4
WM207	S/S	CVD	5 3/4
WM496	S/S	CVD	7
WM206	S/S	CVD	9 1/4

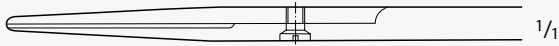

WM260

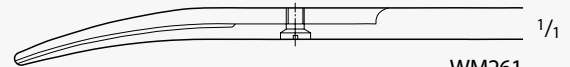

WM261



WM262

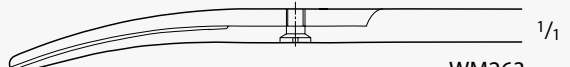

WM263

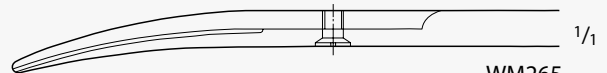

WM265



WM260 - WM265

DUROTIP TC METZENBAUM Dissecting Scissors

Catalog Number	Tip	Blade	Length (in.)
WM260	B/B	STR	5 3/4
WM262	B/B	STR	7
WM261	B/B	CVD	5 3/4
WM263	B/B	CVD	7
WM265	B/B	CVD	7 7/8

INCHES





WM287

1/2

DUROTIP TC METZENBAUM Dissecting Scissors

Catalog Number	Tip	Blade	Length (in.)
WM287	B/B	CVD	9

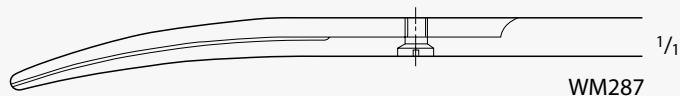

WM287

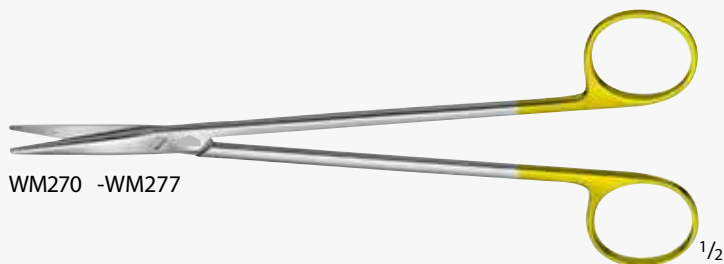

WM270 -WM277

1/2

DUROTIP TC METZENBAUM Dissecting Scissors, Delicate

Catalog Number	Tip	Blade	Length (in.)
WM270	B/B	STR	7
WM274	B/B	STR	7 7/8
WM276	B/B	STR	9
WM271	B/B	CVD	7
WM275	B/B	CVD	7 7/8
WM277	B/B	CVD	9

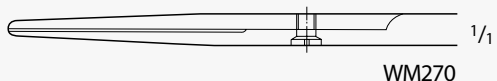

WM270

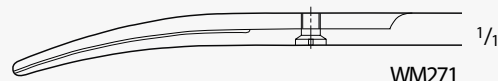

WM271

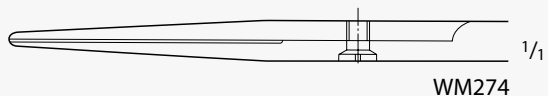

WM274

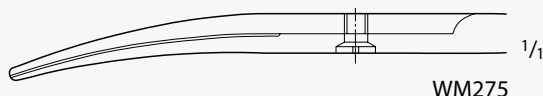

WM275

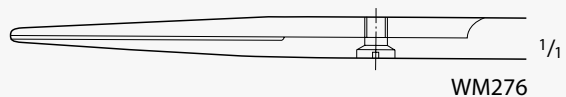

WM276



WM277

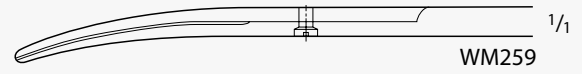
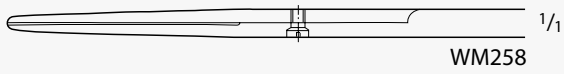

DUROTIP TC Baby METZENBAUM  
Dissecting Scissors, Delicate

Catalog Number	Tip	Blade	Length (in.)
WM258	B/B	STR	5 3/4
WM259	B/B	CVD	5 3/4

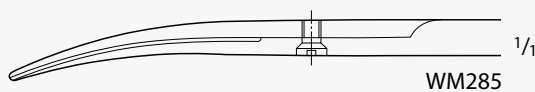
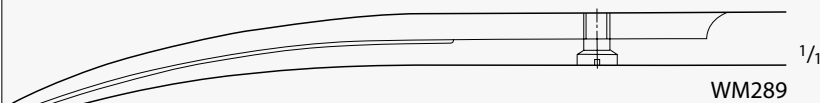
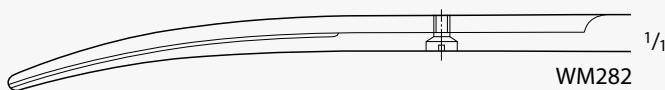
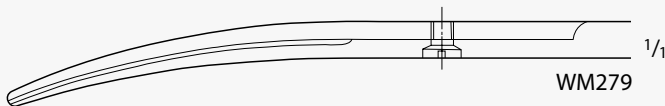
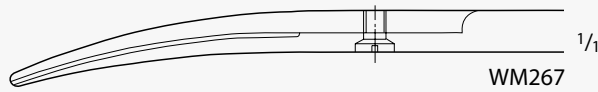
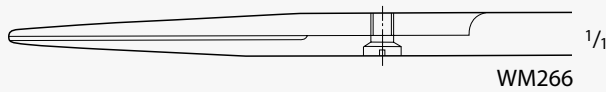

DUROTIP TC NELSON-METZENBAUM  
Dissecting Scissors

Catalog Number	Tip	Blade	Length (in.)
WM266	B/B	STR	9
WM267	B/B	CVD	9
WM279	B/B	CVD	10 1/4
WM281	B/B	CVD	11
WM282	B/B	CVD	11 1/4
WM289	B/B	CVD	11 3/4
WM285	B/B	CVD	13 3/4

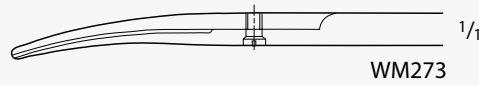

DUROTIP TC TOENNIS-ADSON  
 Dissecting Scissors, Delicate

Catalog Number	Tip	Blade	Length (in.)
WM273	B/B	CVD	6 7/8

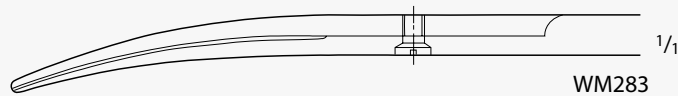

DUROTIP TC LEXER Dissecting Scissors,  
 Delicate

Catalog Number	Tip	Blade	Length (in.)
WM283	B/B	CVD	6 1/2





Wavecut

■ Wavecut scissors have one serrated cutting edge to prevent tissue from slipping. The W after the item number indicates the scissors are the wavecut style, e.g. WM211.



WM253

1/2

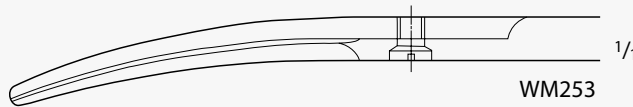

1/1

WM253

DUROTIP TC MAYO Wavecut Dissecting Scissors, Beveled Blades

Catalog Number	Tip	Blade	Length (in.)
WM253	B/B	CVD	6 3/4



WM259

1/2

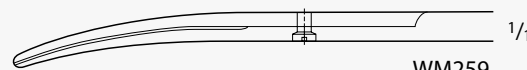

1/1

WM259

DUROTIP TC Baby METZENBAUM Wavecut Dissecting Scissors, Delicate

Catalog Number	Tip	Blade	Length (in.)
WM259	B/B	CVD	5 3/4

INCHES



WM261 -WM265

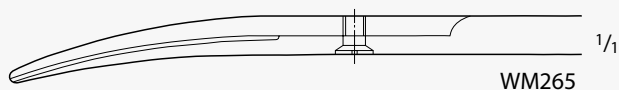
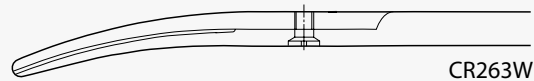
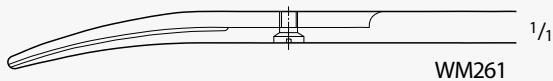

DUROTIP TC METZENBAUM Wavecut  
Dissecting Scissors

Catalog Number	Tip	Blade	Length (in.)
WM261	B/B	CVD	5 3/4
WM263	B/B	CVD	7
WM265	B/B	CVD	7 7/8

WM271 -WM277

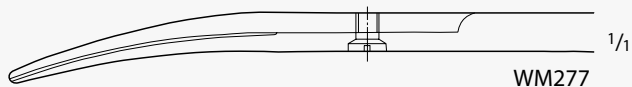
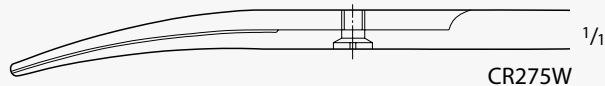
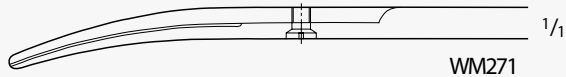
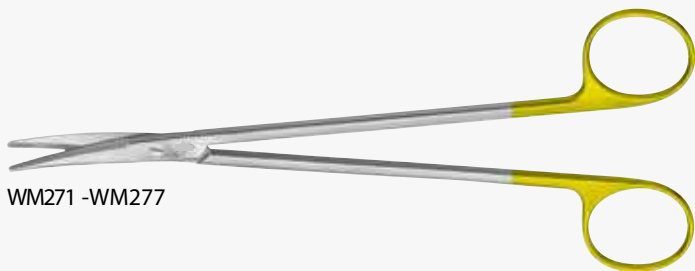

DUROTIP TC METZENBAUM Wavecut  
Dissecting Scissors, Delicate

Catalog Number	Tip	Blade	Length (in.)
WM271	B/B	CVD	7
WM275	B/B	CVD	7 7/8
WM277	B/B	CVD	9

WM287

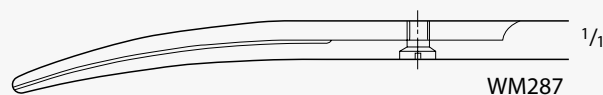

DUROTIP TC METZENBAUM  
Wavecut Dissecting Scissors, Heavy

Catalog Number	Tip	Blade	Length (in.)
WM287	B/B	CVD	9

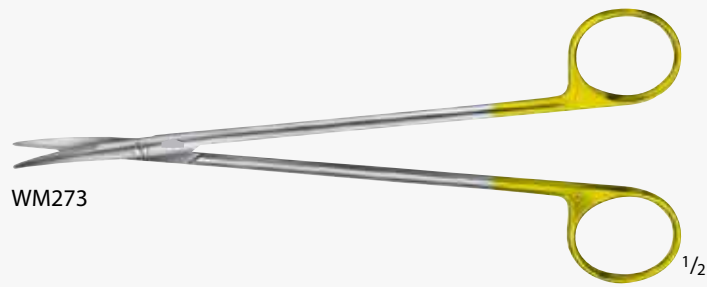

WM273

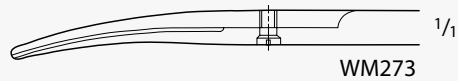

WM273

DUROTIP TC TOENNIS-ADSON Wavecut Dissecting Scissors

Catalog Number	Tip	Blade	Length (in.)
WM273	B/B	CVD	6 7/8



WM267



WM267



WM279-WM281



WM279

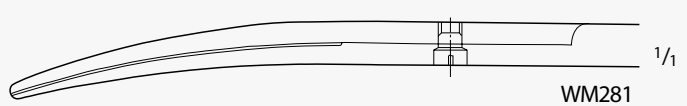

WM281

DUROTIP TC NELSON-METZENBAUM Wavecut Dissecting Scissors

Catalog Number	Tip	Blade	Length (in.)
WM267	B/B	CVD	9
WM279	B/B	CVD	10 1/4
WM281	B/B	CVD	11

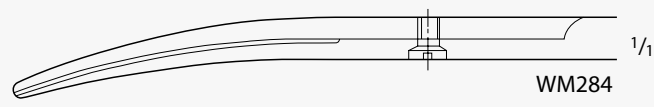

DUROTIP TC MAYO-LEXER Wavecut Scissors

Catalog Number	Tip	Blade	Length (in.)
WM284	B/B	CVD	6 1/2

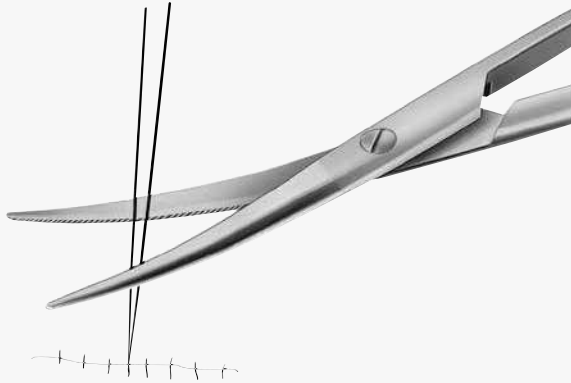

DUROTIP TC Ligature Scissors

- Carbide inserts guarantee permanent sharp cutting edge (also in the distal area of the blades).
- Wavecut prevents suture materials from slipping.
- Identified by 1 gold-plated ring.

INCHES



WM294 -WM298

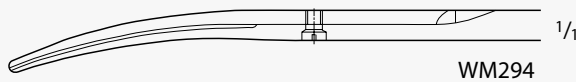

WM294

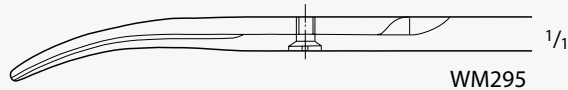

WM295

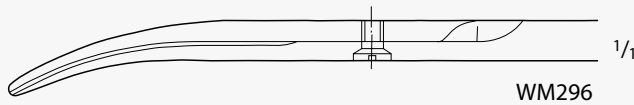

WM296

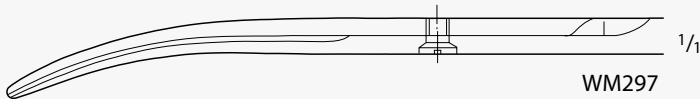

WM297

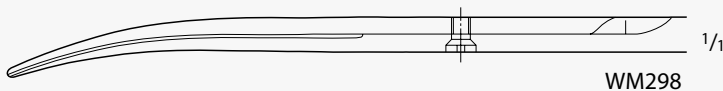

WM298

DUROTIP TC Ligature Wavecut Scissors

Catalog Number	Tip	Blade	Length (in.)
WM294	B/B	CVD	5 3/4
WM295	B/B	CVD	7
WM296	B/B	CVD	9
WM297	B/B	CVD	10 1/4
WM298	B/B	CVD	13 3/4



SuperCut Scissors

Your everyday black handle scissors

- Microtome Edge
  - Razor sharp cutting edge facilitates gentle cutting with minimal force
- Wavecut Blade
  - Prevents tissue from slipping out during the cutting process

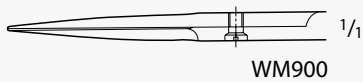

Iris SuperCut Scissors, Delicate

Catalog Number	Tip	Blade	Length (in.)
WM900	S/S	STR	4 1/4
WM901	S/S	CVD	4 1/4

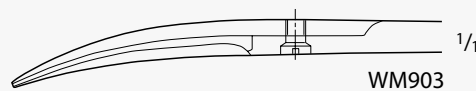
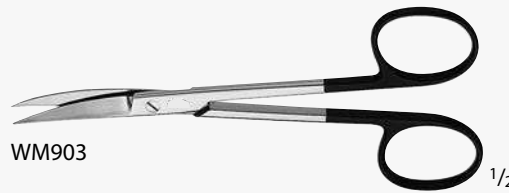

SuperCut Plastic Standard Scissors

Catalog Number	Tip	Blade	Length (in.)
WM903	S/S	CVD	5

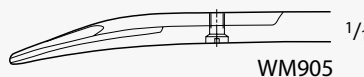
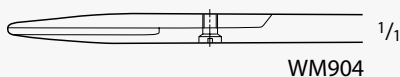

STEVENS SuperCut Scissors

Catalog Number	Tip	Tip Size (mm)	Blade	Length (in.)
WM904	B/B	12	STR	4 1/8
WM905	B/B	12	CVD	4 1/8

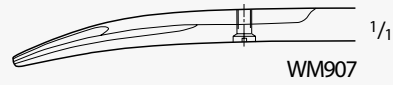
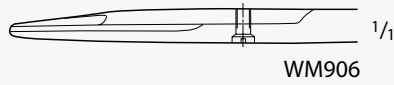

STEVENS SuperCut Scissors (continued)

Catalog Number	Tip	Tip Size (mm)	Blade	Length (in.)
WM906	B/B	13	STR	4 1/4
WM907	B/B	13	CVD	4 1/4



GOLDMANN-FOX SuperCut Scissors

Catalog Number	Tip	Blade	Length (in.)
WM909	S/S	CVD	5 1/8

INCHES



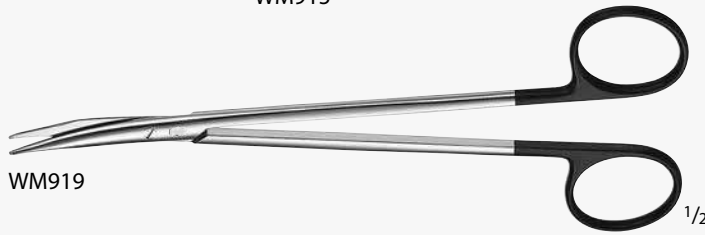

JAMESON SuperCut Scissors, Delicate

Catalog Number	Tip	Blade	Length (in.)
WM911	B/B	CVD	5 1/8
WM915	B/B	CVD	6
WM919	B/B	CVD	7

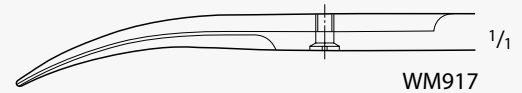
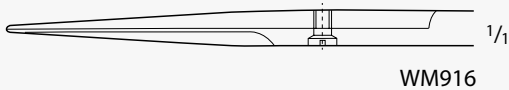

JOSEPH SuperCut Scissors, Delicate

Catalog Number	Tip	Blade	Length (in.)
WM916	S/S	STR	6
WM917	S/S	CVD	6

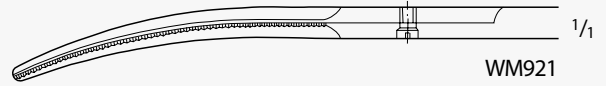
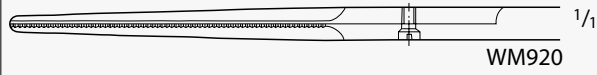

GORNEY SuperCut Scissors, Delicate

Catalog Number	Tip	Blade	Length (in.)
WM920	B/B	STR	7 3/4
WM921	B/B	CVD	7 3/4

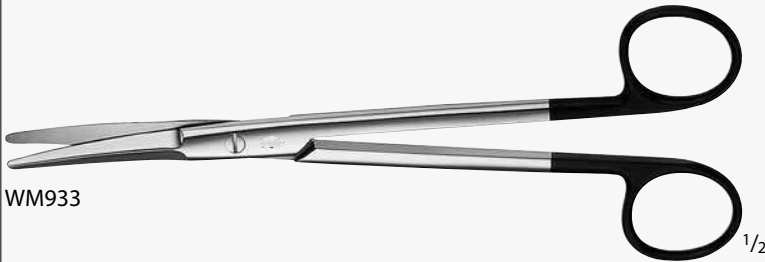

WM933

KAYE SuperCut Facelift Scissors, Delicate

Catalog Number	Tip	Blade	Length (in.)
WM933	B/B	CVD	7 3/4

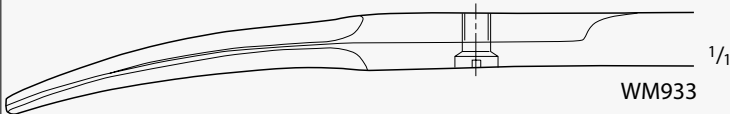

WM926 -WM927

MAYO SuperCut Scissors, Delicate

Catalog Number	Tip	Blade	Length (in.)
WM926	B/B	STR, BEVELED	5 3/4
WM927	B/B	CVD, BEVELED	5 3/4
WM924	B/B	STR, ROUND	6 1/2
WM925	B/B	CVD, ROUND	6 1/2

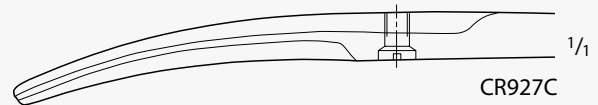
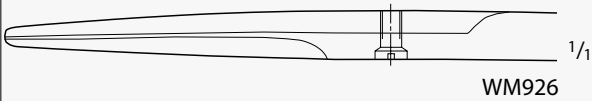

WM924 -WM925

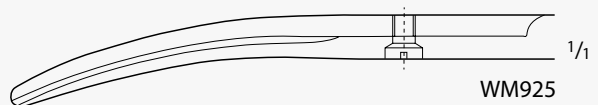
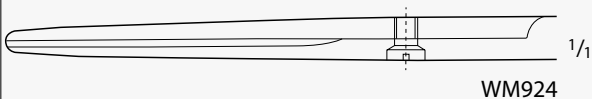



WM922 -WM216

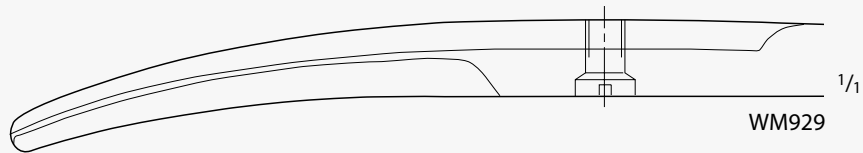
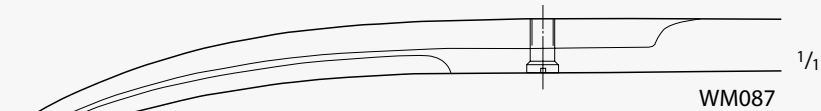
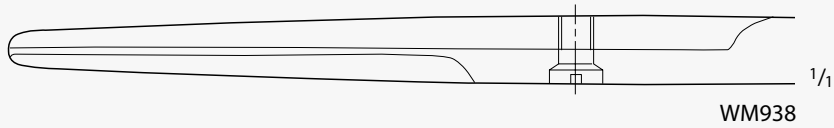
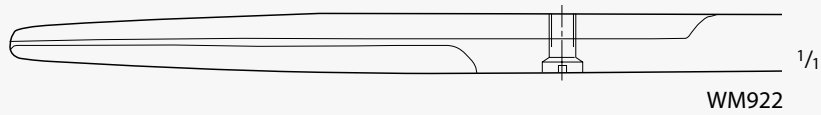
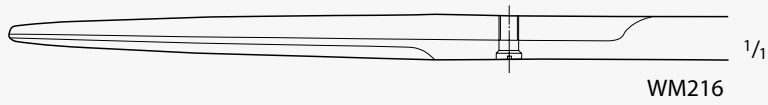

MAYO SuperCut Scissors, Beveled

Catalog Number	Tip	Blade	Length (in.)
WM216	B/B	STR	9
WM922	B/B	STR	10
WM938	B/B	STR	12
WM087	B/B	CVD	9
WM929	B/B	CVD	11

INCHES



WM930 -WM931

1/2



WM930

1/1

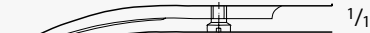

WM931

1/1

Baby METZENBAUM SuperCut Scissors, Delicate

Catalog Number	Tip	Blade	Length (in.)
WM930	B/B	STR	4 1/2
WM931	B/B	CVD	4 1/2



WM934 -WM937

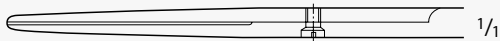

WM934

1/1

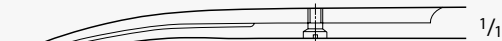

WM935

1/1

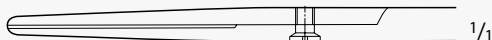

WM936

1/1

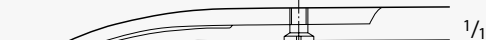

WM937

1/1

METZENBAUM SuperCut Scissors, Delicate

Catalog Number	Tip	Blade	Length (in.)
WM934	B/B	STR	5 3/4
WM936	B/B	STR	7
WM935	B/B	CVD	5 3/4
WM937	B/B	CVD	7

WM945 -WM953

1/1

WM945

1/1

WM947

1/1

WM949

1/1

WM951

1/1

WM953

**METZENBAUM SuperCut Scissors, Delicate**

Catalog Number	Tip	Blade	Length (in.)
WM945	B/B	CVD	9
WM947	B/B	CVD	10 1/4
WM949	B/B	CVD	11 1/4
WM951	B/B	CVD	11 3/4
WM953	B/B	CVD	14

1/1

WM957

1/1

WM958

1/1

WM959

**POTTS-SMITH SuperCut Scissors**

Catalog Number	Tip	Blade Angle	Blade Size (mm)	Length (in.)
WM957	B/B	25°	22	7 1/2
WM958	B/B	45°	20	7 1/4
WM959	B/B	60°	19	7

WM957 -WM959



INCHES

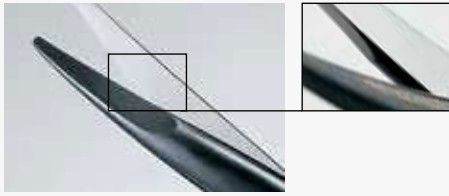

Microtome Edge

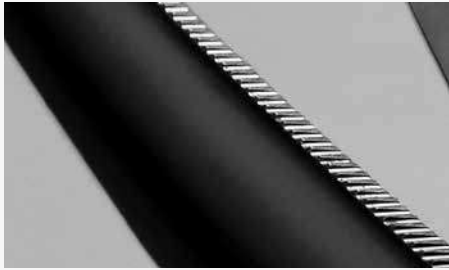

Wavecut

Noir Supreme Cut Scissors

■ Noir

Noir coating results in an extremely high surface hardness and therefore high wear resistance in daily hospital use.

■ Microtome edge

The extremely sharp cutting edge of the scissors blade facilitates gentle cutting of tissue with minimal use of force.

■ Wavecut prevents tissue from slipping out during the cutting process.

■ The WB after the item number indicates the Noir scissors are the wavecut style, e.g. WM211.

For more information about Noir Supreme Cut Scissors see our brochure number .



WM252



WM253B, WM253



WM252 -WM253

Noir MAYO Dissecting Scissors

Catalog Number	Tip	Blade	Length (in.)
WM252	B/B	STR	6 3/4
WM253	B/B	CVD	6 3/4
WM253	B	CVD	6 3/4



WM284- WM284



WM284- WM284

Noir MAYO-LEXER Dissecting Scissors

Catalog Number	Tip	Blade	Length (in.)
WM284	B/B	CVD	6 1/2
WM284	B/B	CVD	6 1/2



WM283B-WM283W

1/2



WM283B-WM283WB

1/1

### Noir LEXER Dissecting Scissors

Catalog Number	Tip	Blade	Length (in.)
WM283B	B/B	DEL, CVD	6 1/2
WM283W	B/B	DEL, CVD	6 1/2



WM210B-WM211W

1/2



WM210B

1/1



WM11B, WM211W

1/1

### Noir Iris Dissecting Scissors

Catalog Number	Tip	Blade	Length (in.)
WM210B	S/S	STR	4 1/4
WM211B	S/S	CVD	4 1/4
WM211W	S/S	CVD	4 1/4



WM273B-WM273W

1/2



WM273B-WM273W

1/1

### Noir TOENNIS-ADSON Dissecting Scissors

Catalog Number	Tip	Blade	Length (in.)
WM273B	B/B	DEL, CVD	6 7/8
WM273W	B/B	DEL, CVD	6 7/8



WM261B-WM277W



WM261B, WM261W



WM263B, WM263W



WM271B, WM71W



WM265B, WM265W



WM275B, WM275W



WM267B, WM267W



WM277B, WM277W

Noir METZENBAUM Dissecting Scissors

Catalog Number	Tip	Blade	Length (in.)
WM261B	B/B	CVD	5 3/4
WM261W	B/B	CVD	5 3/4
WM263B	B/B	CVD	7
WM263W	B/B	CVD	7
WM271B	B/B	DEL, CVD	7
WM271W	B/B	DEL, CVD	7
WM265B	B/B	CVD	7 7/8
WM265W	B/B	CVD	7 7/8
WM275B	B/B	DEL, CVD	7 7/8
WM275W	B/B	DEL, CVD	7 7/8
WM267B	B/B	CVD	9
WM267W	B/B	CVD	9
WM277B	B/B	DEL, CVD	9
WM277W	B/B	DEL, CVD	9





WM279B-WM281W



WM279B, CR279W



WM281B, CR281W

Noir NELSON-METZENBAUM  
Dissecting Scissors

Catalog Number	Tip	Blade	Length (in.)
WM279B	B/B	DEL, CVD	10 1/4
WM279W	B/B	DEL, CVD	10 1/4
WM281B	B/B	DEL, CVD	11
WM281W	B/B	DEL, CVD	11

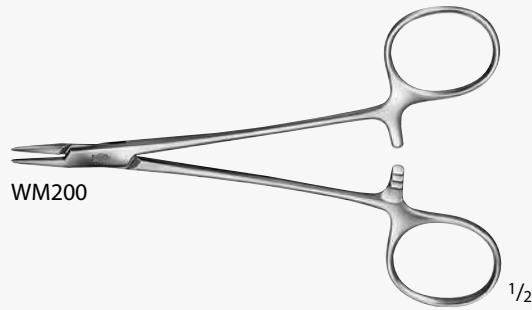

WM200

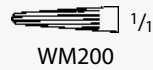

WM200

CONVERSE Needle Holder

Catalog Number	Jaw	Length (in.)
WM200	LONG SERR	5 1/8

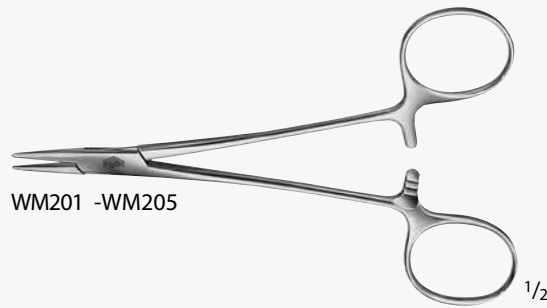

WM201 -WM205

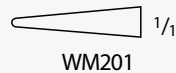

WM201



WM205

HALSEY Needle Holder

Catalog Number	Tip	Jaw	Length (in.)
WM201	DEL	SMOOTH	5 1/8
WM205	DEL	X-SERR	5 1/8



WM202

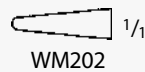

WM202

WEBSTER Needle Holder

Catalog Number	Jaw	Length (in.)
WM202	SMOOTH	5



WM204



WM204

DERF Needle Holder

Catalog Number	Jaw	Length (in.)
WM204	SERR	5



WM210

1/2



WM210

1/1

DOYEN Needle Holder

Catalog Number	Jaw	Length (in.)
WM210	X-SERR	5

INCHES

1

2

3

4

5

6

7

8

9

10

11

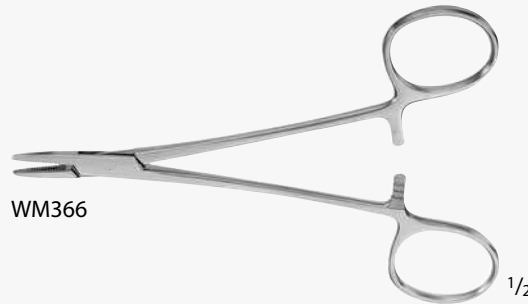

WM366

1/2



WM366

1/1

COLLIER Needle Holder, Fenestrated

Catalog Number	Jaw	Length (in.)
WM366	SERR	5



WM215 , WM072

1/2



WM072

1/1



WM215

1/1

BAUMGARTNER Needle Holder

Catalog Number	Jaw	Length (in.)
WM072	SERR, GROOVED	5 1/4
WM215	X-SERR	5 3/4

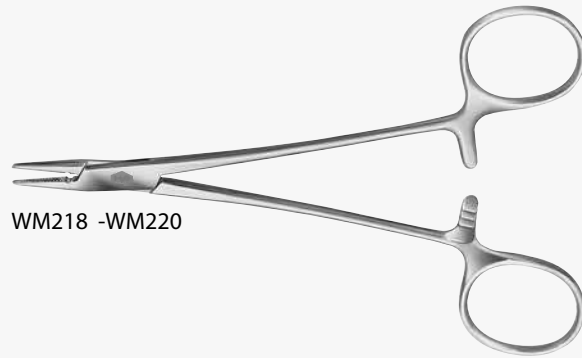

WM218 -WM220

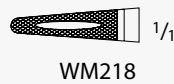

WM218



WM220

CRILE-WOOD Needle Holder

Catalog Number	Jaw	Length (in.)
WM218	X-SERR	6
WM220	X-SERR	6 1/4



WM219



WM219

CRILE-MURRAY Needle Holder

Catalog Number	Jaw	Length (in.)
WM219	SERR	6

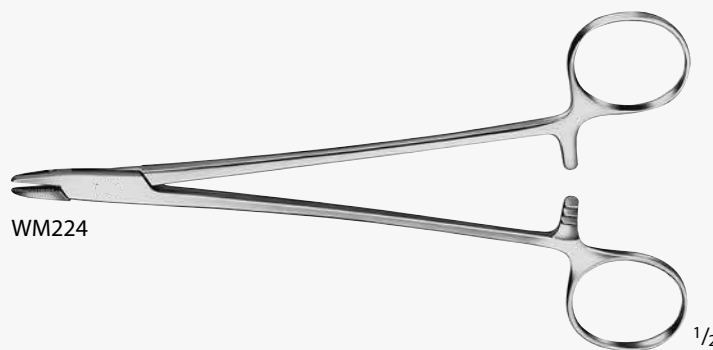

WM224



WM224

ADSON Needle Holder, Fenestrated

Catalog Number	Jaw	Length (in.)
WM224	SERR	7

INCHES



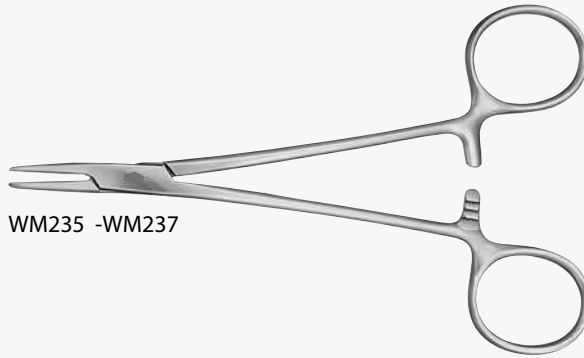
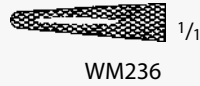
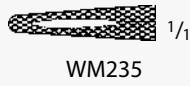

MAYO-HEGAR Needle Holder

Catalog Number	Jaw	Length (in.)
WM235	X-SERR	6
WM236	X-SERR	7 1/4
WM237	X-SERR	7 7/8

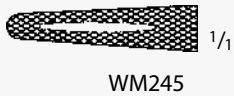

HEGAR Needle Holder

Catalog Number	Tip	Jaw	Length (in.)
WM245	HEAVY	X-SERR	6
WM247	HEAVY	X-SERR	6 7/8
WM249	HEAVY	X-SERR	8
WM255	HEAVY	X-SERR	8

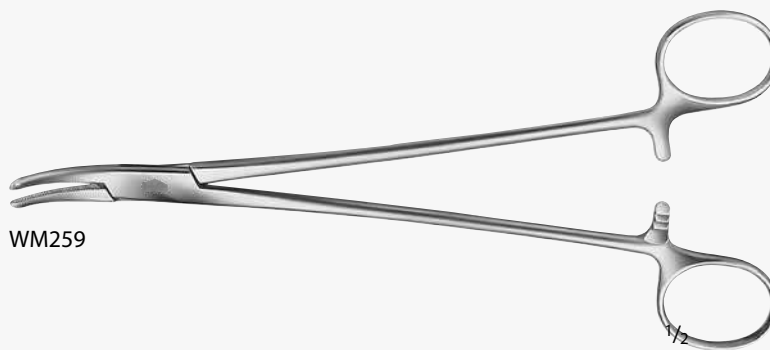

HEANEY Needle Holder

Catalog Number	Tip	Jaw	Length (in.)
WM259	CVD	SERR	7 7/8

INCHES



INCHES

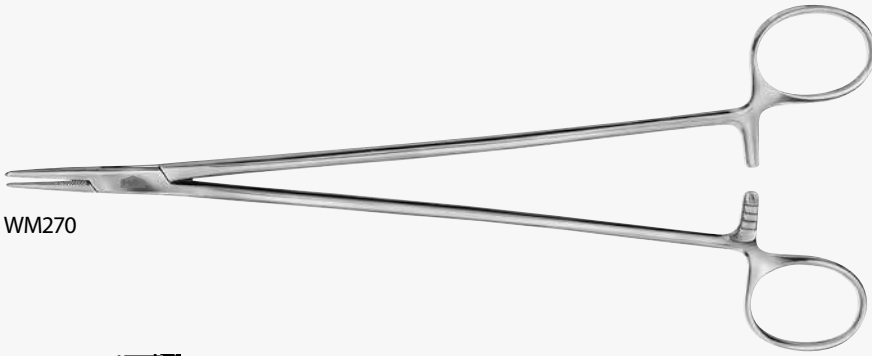

WM270

JAMESON Needle Holder

Catalog Number	Tip	Jaw	Length (in.)
WM270	DEL	X-SERR	9

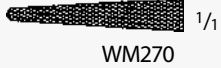

WM270

1/2

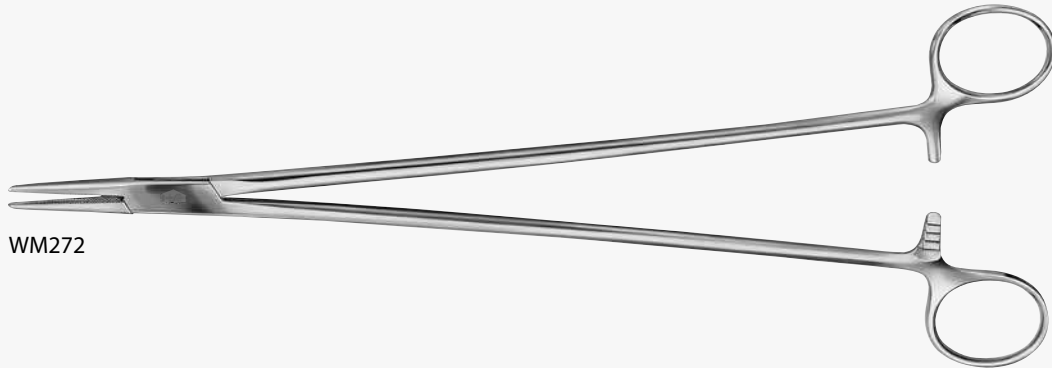

WM272

WANGENSTEEN Needle Holder

Catalog Number	Jaw	Length (in.)
WM272	X-SERR	10 3/4



WM272

1/2

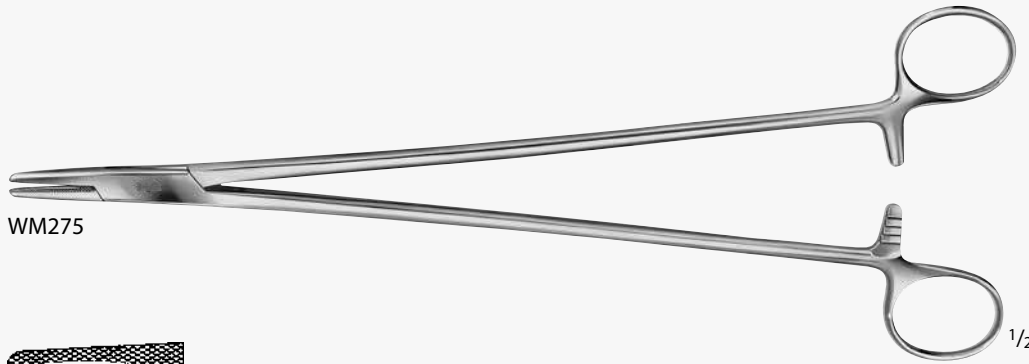

WM275

MASSON Needle Holder

Catalog Number	Jaw	Length (in.)
WM275	X-SERR	10 1/2



WM275

1/2



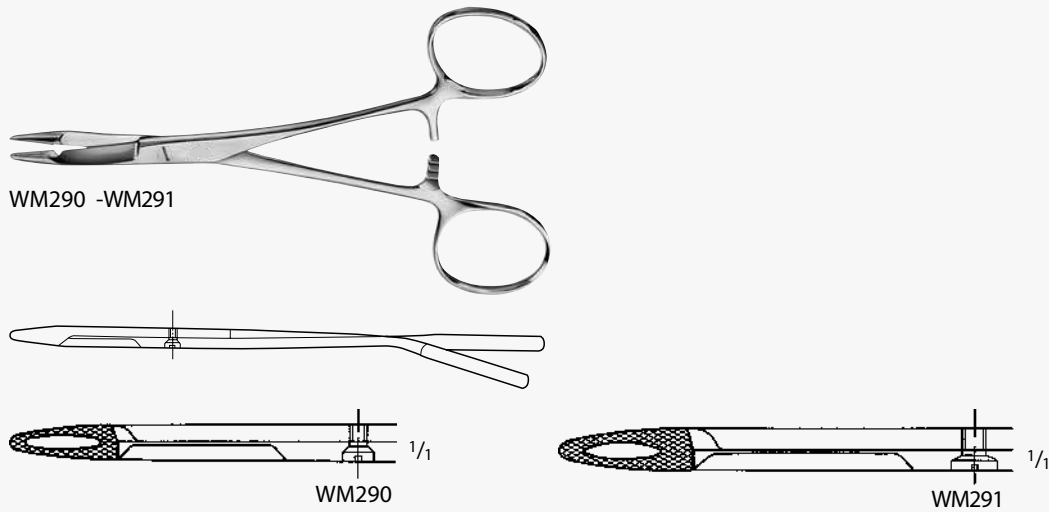

HEGAR-OLSEN Needle Holder/Scissors

Catalog Number	Jaw	Length (in.)
WM290	SERR	5 1/2
WM291	SERR	7 1/4

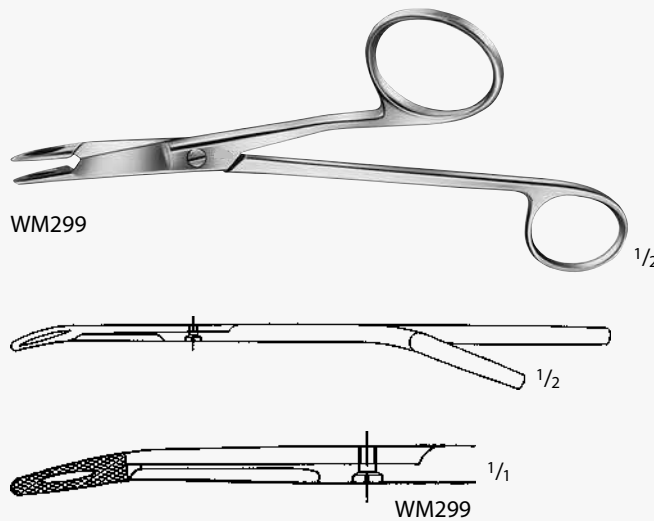

GILLIES Needle Holder/Scissors

Catalog Number	Jaw	Length (in.)
WM299	SERR	6 1/4

Aesculap features Needle Holders with Tungsten Carbide (TC) inserts. A smooth jaw and three different serration patterns are available, depending on the size of the suture needle.

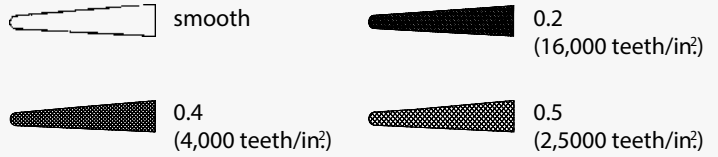
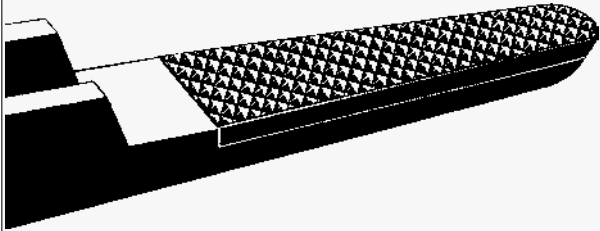

We recommend carbide inserts as follows:

Jaw Surface	Suture Material
Smooth	9/0 - 11/0
0.2 mm pitch of serration	6/0 - 10/0
0.4 mm pitch of serration	4/0 - 6/0
0.5 mm pitch of serration	up to 3/0

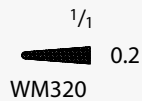

DUROGRIP TC HELLBERG-KUPKA Needle Holder W/ Ergonomic Handle

Catalog Number	Jaw	Length (in.)
WM320	SERR	8 1/4

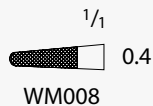

DUROGRIP TC DERF Needle Holder

Catalog Number	Jaw	Length (in.)
WM008	SERR	4 3/4

INCHES



WM009

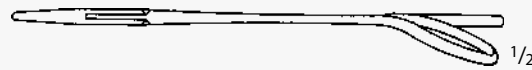

DUROGRIP TC MASING Needle Holder

Catalog Number	Jaw	Length (in.)
WM009	SERR	5 1/8



WM010

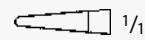

WM010



WM012



WM012

DUROGRIP TC HALSEY Needle Holder

Catalog Number	Jaw	Length (in.)
WM010	SMOOTH	4 3/4
WM012	SERR	5 1/8

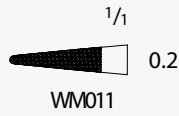

DUROGRIP TC CONVERSE Needle Holder

Catalog Number	Jaw	Length (in.)
WM011	SERR	5 1/8

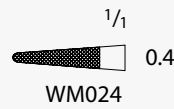
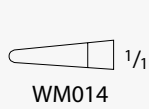
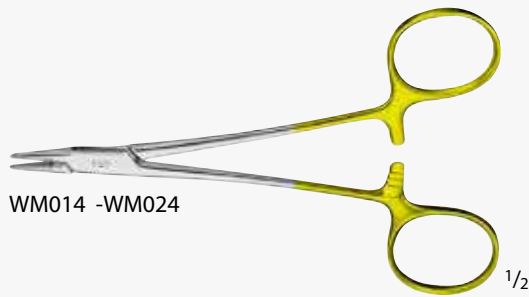

DUROGRIP TC WEBSTER Needle Holder

Catalog Number	Jaw	Length (in.)
WM014	SMOOTH	5 1/8
WM024	SERR	5 1/8

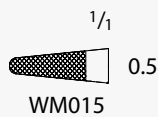

DUROGRIP TC BAUMGARTNER Needle Holder

Catalog Number	Jaw	Length (in.)
WM015	SERR	5 3/4

INCHES

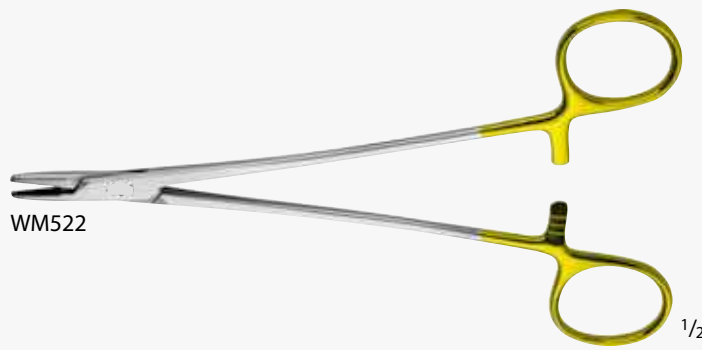

WM522

1/2



WM522

DUROGRIP TC NEW ORLEANS Needle Holder

Catalog Number	Jaw	Length (in.)
WM522	SERR	7

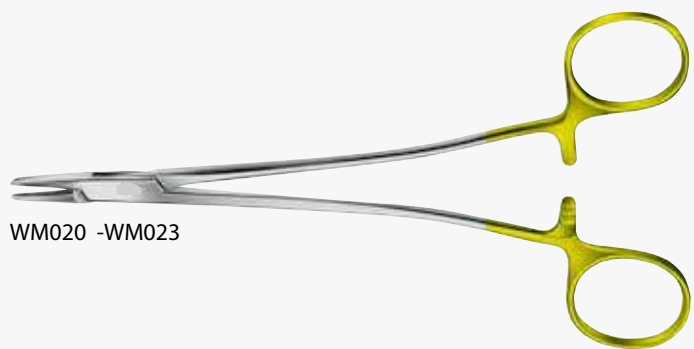

WM020 -WM023

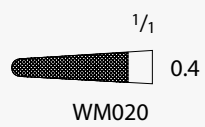

WM020

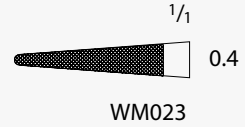

WM023

DUROGRIP TC SAROT Needle Holder

Catalog Number	Jaw	Length (in.)
WM020	SERR	7
WM023	SERR	10 1/4



WM013

1/2

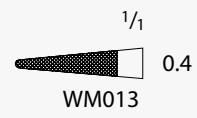

WM013

DUROGRIP TC Baby CRILE-WOOD Needle Holder

Catalog Number	Jaw	Length (in.)
WM013	SERR	6



WM016 , WM021 , WM604

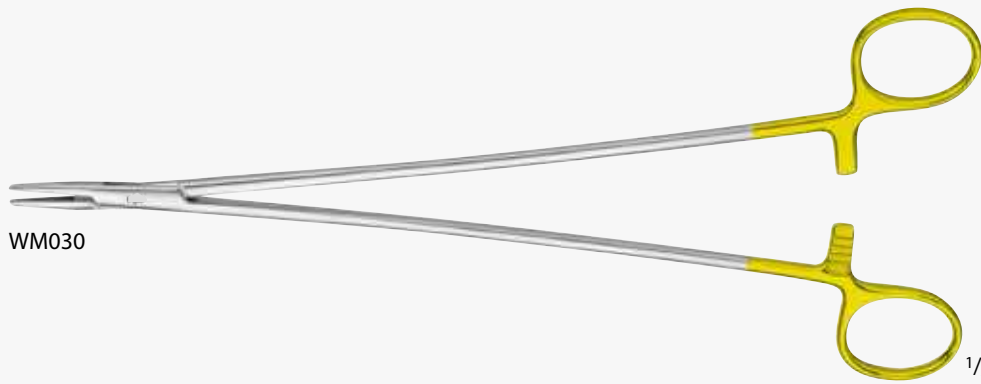
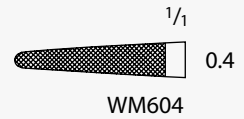
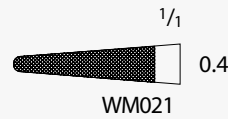
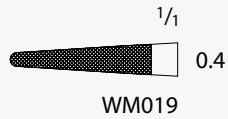
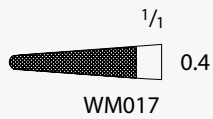
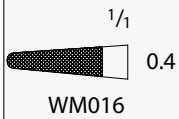

WM030

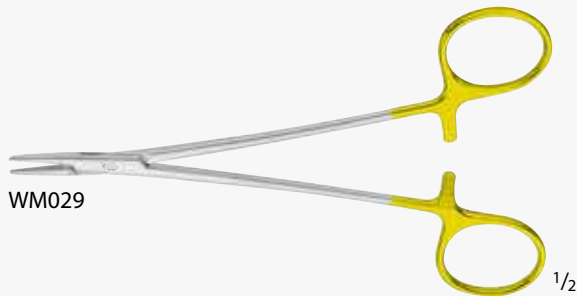
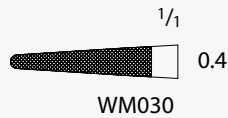

WM029

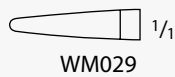

DUROGRIP TC CRILE-WOOD Needle Holder

Catalog Number	Jaw	Length (in.)
WM016	SERR	5 3/4
WM017	SERR	7 1/4
WM019	SERR	7 7/8
WM030	SERR	10 5/8
WM021	SERR	12
WM604	SERR	14
WM029	SMOOTH	6





WM022

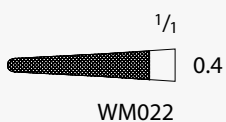

DUROGRIP TC MAYO-HEGAR-SEELEY  
Needle Holder

Catalog Number	Jaw	Length (in.)
WM022	SERR	8

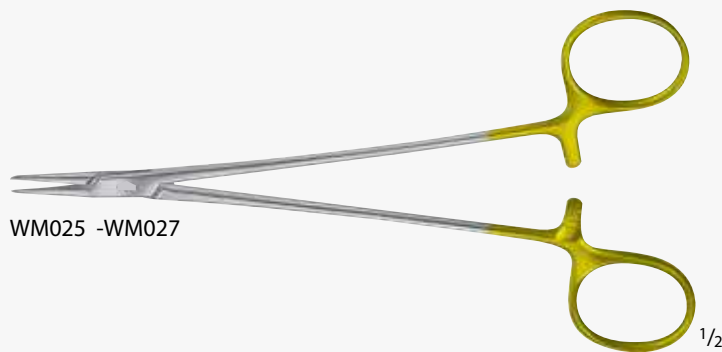

WM025 -WM027



DUROGRIP TC Fine Needle Holder

Catalog Number	Tip	Jaw	Length (in.)
WM025	X-DEL	SERR	7
WM026	X-DEL	SERR	7 7/8
WM027	X-DEL	SERR	9



WM035 -WM038  
1/1 0.4  
WM035

1/1 0.4  
WM036

1/1 0.4  
WM037

1/1 0.4  
WM038

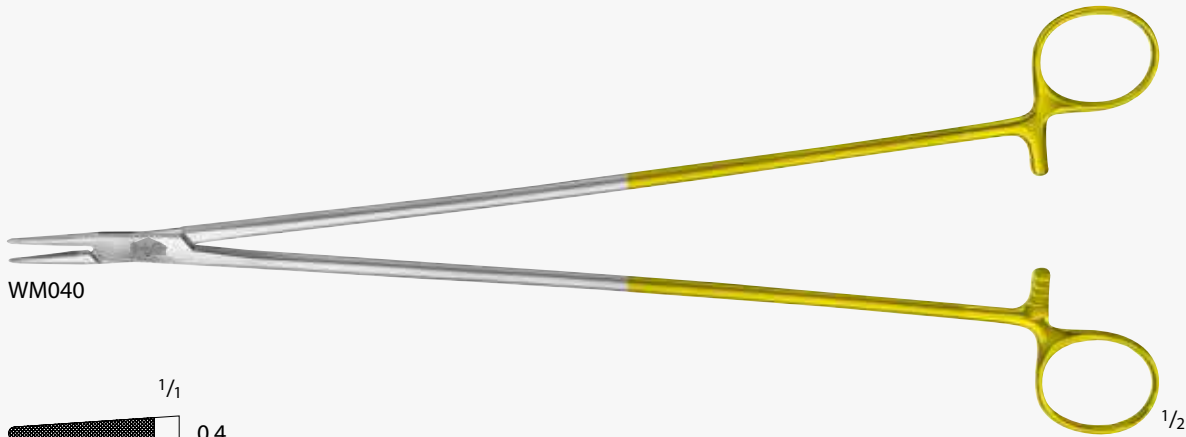

WM040  
1/1 0.4  
WM040

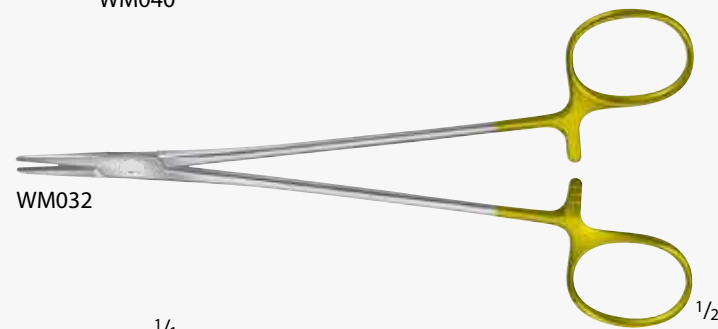

WM032  
1/1 0.4  
WM032

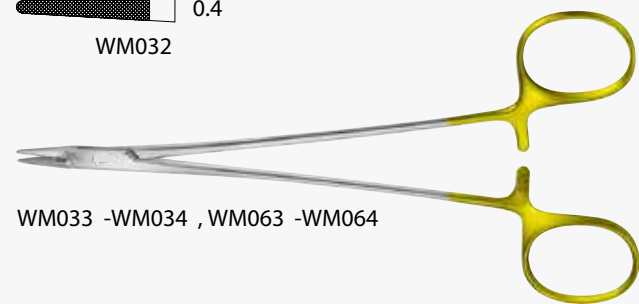

WM033 -WM034 , WM063 -WM064  
1/1 0.4  
WM033

1/1 0.4  
WM034

1/1 0.2  
WM063

1/1 0.2  
WM064

DUROGRIP TC DEBAKEY Needle Holder

Catalog Number	Tip	Jaw	Length (in.)
WM032	DEL	SERR	6
WM033	DEL	SERR	6 1/2
WM035	DEL	SERR	7
WM034	DEL	SERR	8 1/4
WM036	DEL	SERR	9
WM037	DEL	SERR	10 1/4
WM038	DEL	SERR	12
WM063	X-DEL	SERR	6 1/2
WM064	X-DEL	SERR	8 1/4
WM040	X-DEL	SERR	12

INCHES



WM054 - WM058



WM054

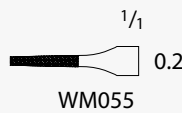

WM055



WM056C

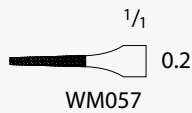

WM057

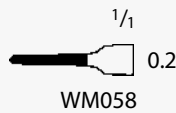

WM058

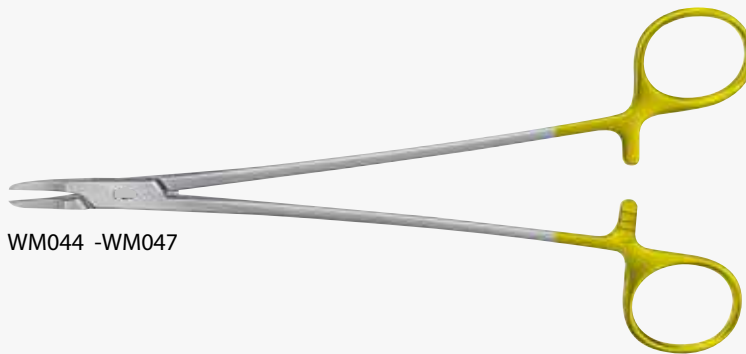

WM044 - WM047

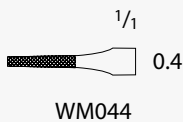

WM044

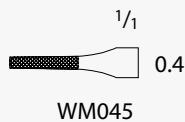

WM045

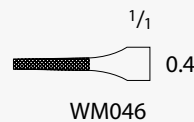

WM046

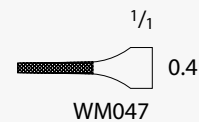

WM047

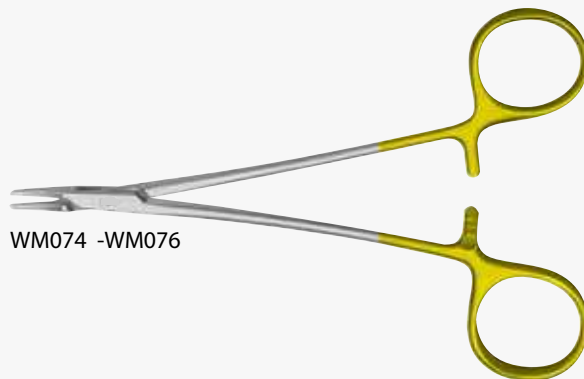

WM074 - WM076



WM074

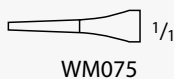

WM075

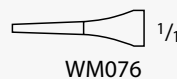

WM076

DUROGRIP TC RYDER Needle Holder

Catalog Number	Tip	Jaw	Length (in.)
WM054	X-DEL	SERR	5 1/4
WM055	X-DEL	SERR	6 1/8
WM056	X-DEL	SERR	6 7/8
WM057	X-DEL	SERR	8 1/4
WM058	X-DEL	SERR	9
WM044	DEL	SERR	5 1/4
WM045	DEL	SERR	6 7/8
WM046	DEL	SERR	7 3/4
WM047	DEL	SERR	10 1/2
WM074	DEL	SMOOTH	6
WM075	DEL	SMOOTH	7
WM076	DEL	SMOOTH	8 7/8

INCHES



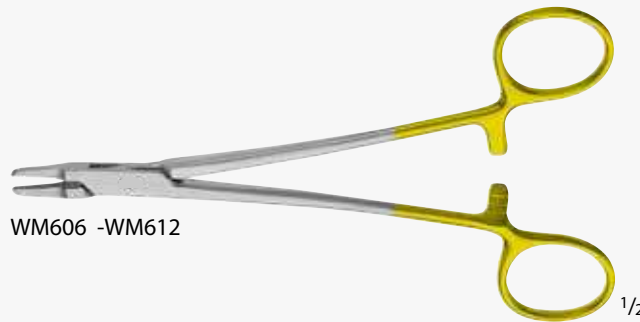

WM606 -WM612



WM606



WM607



WM611



WM612

DUROGRIP TC FRENCH Eye Needle Holder

Catalog Number	Jaw	Length (in.)
WM606	SERR	6 1/4
WM607	SERR	7 1/4
WM611	SERR	8
WM612	SERR	9 1/4



INCHES



WM065 -WM070

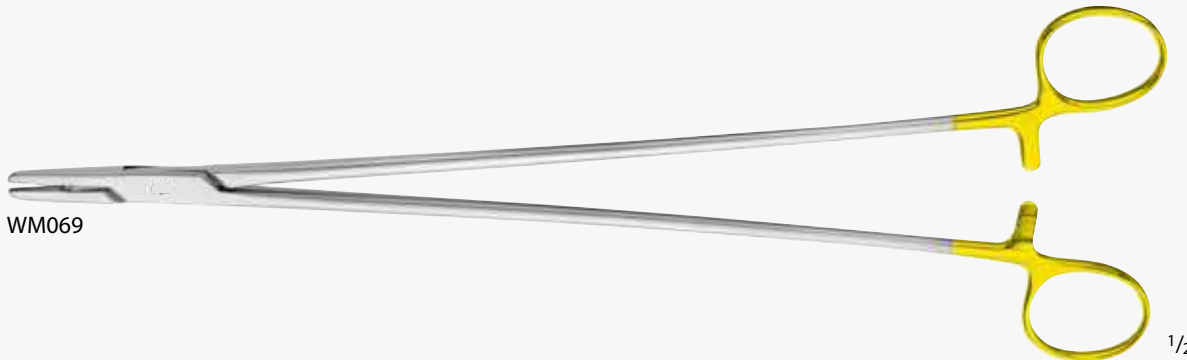
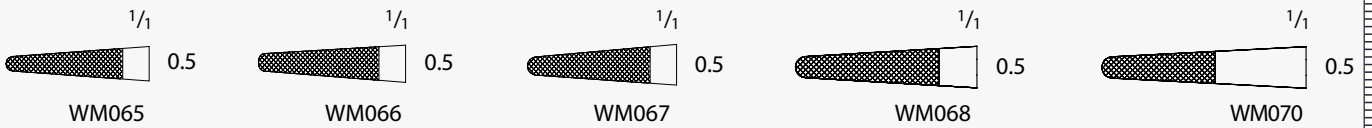

WM069

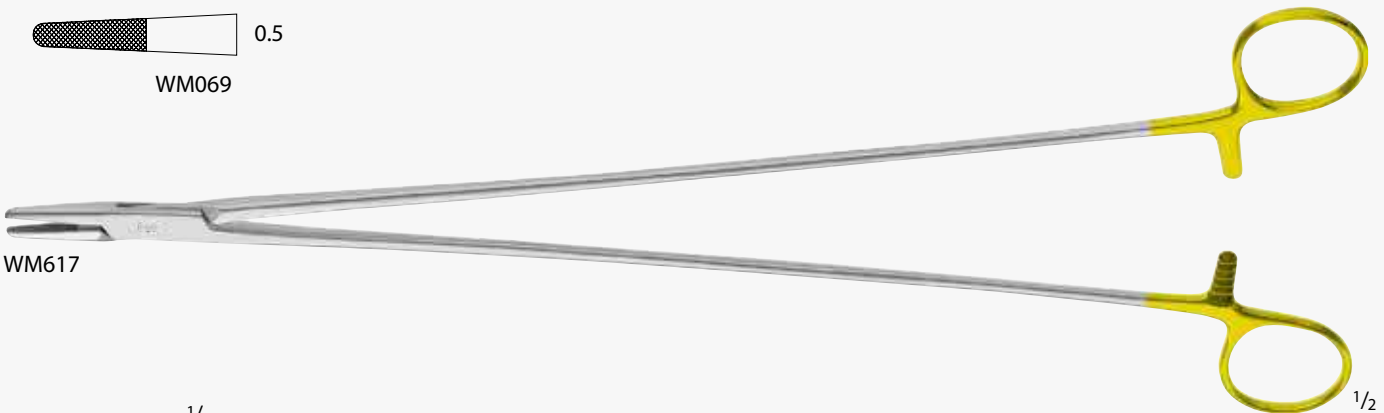
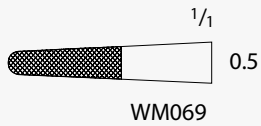

WM617

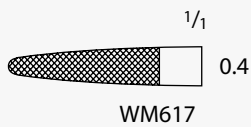

DUROGRIP TC MAYO-HEGAR Needle Holder

Catalog Number	Jaw	Length (in.)
WM065	SERR	6
WM066	SERR	7 1/4
WM067	SERR	8
WM068	SERR	9 1/4
WM070	SERR	10 1/2
WM069	SERR	12
WM617	SERR	14

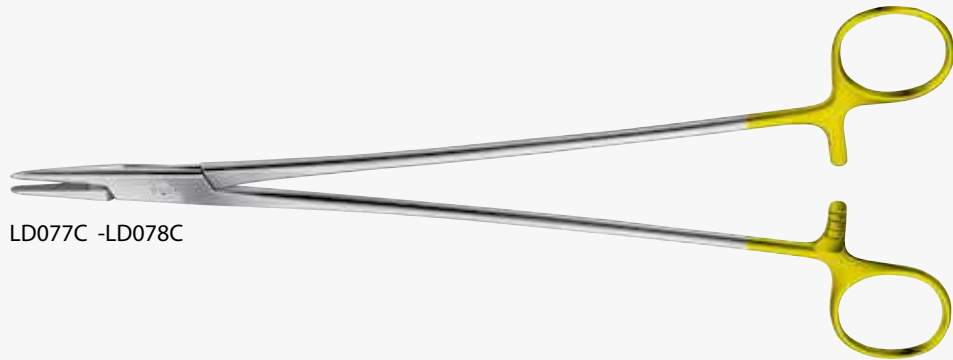

LD077C -LD078C

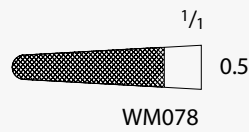
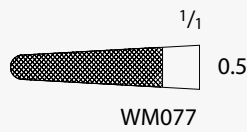

DUROGRIP TC HEGAR Needle Holder

Catalog Number	Tip	Jaw	Length (in.)
WM077	HEAVY	SERR	8
WM078	HEAVY	SERR	9 1/2

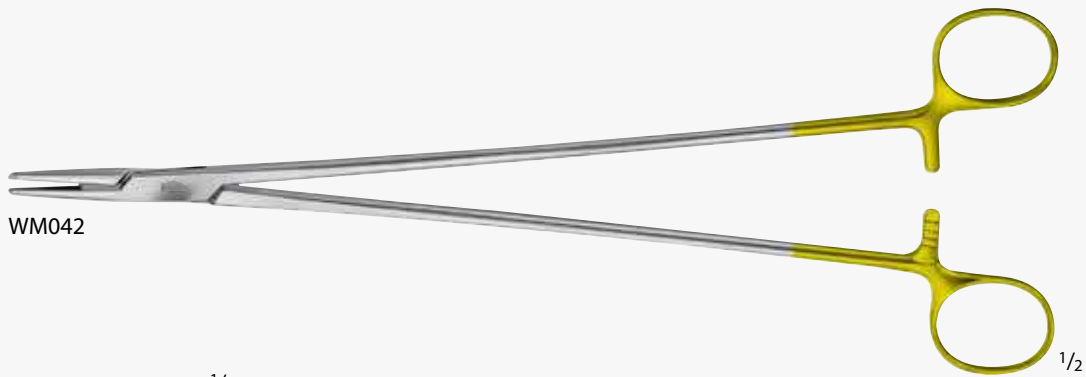

WM042

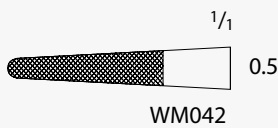

DUROGRIP TC WANGENSTEEN Needle Holder

Catalog Number	Jaw	Length (in.)
WM042	SERR	10 3/4

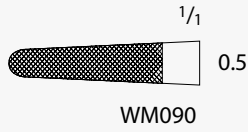

DUROGRIP TC MASSON Needle Holder

Catalog Number	Jaw	Length (in.)
WM090	SERR	10 1/2

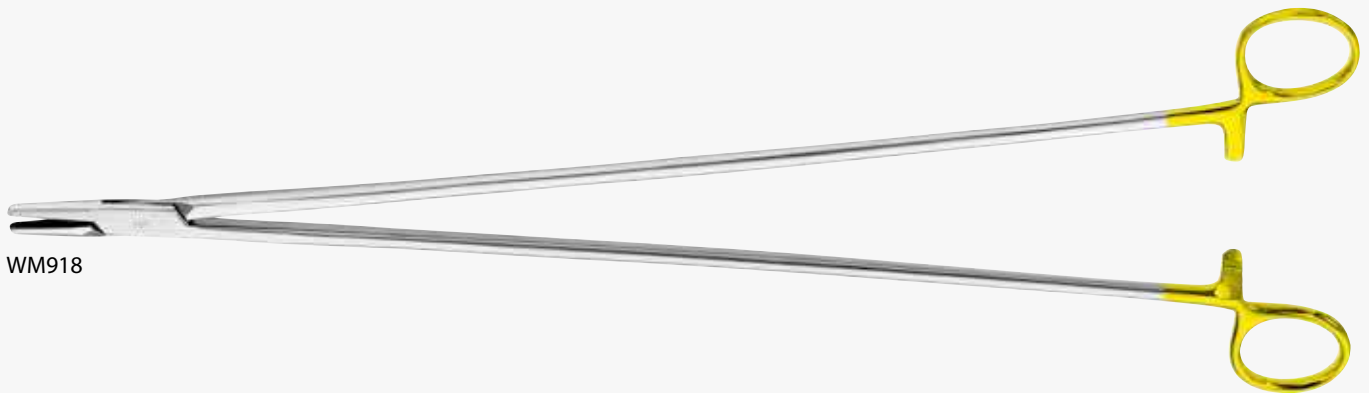

DUROGRIP TC MAYO-MASSON Needle Holder

Catalog Number	Jaw	Length (in.)
WM918	SERR	16

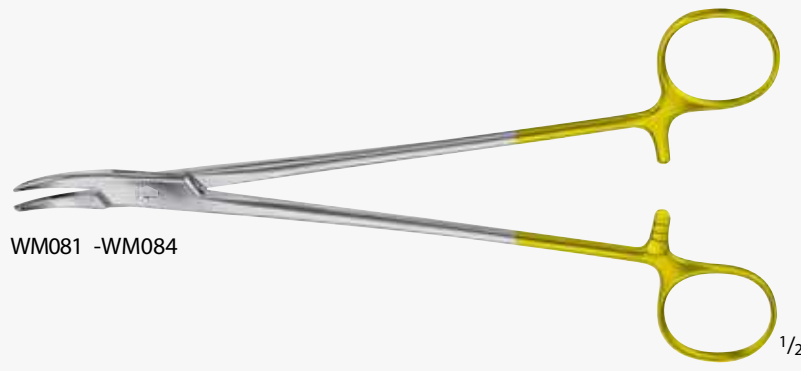

WM081 -WM084

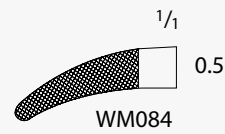
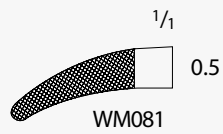

DUROGRIP TC HEANEY Needle Holder

Catalog Number	Tip	Jaw	Length (in.)
WM081	CVD	SERR	7 7/8
WM084	CVD	SERR	10 1/4

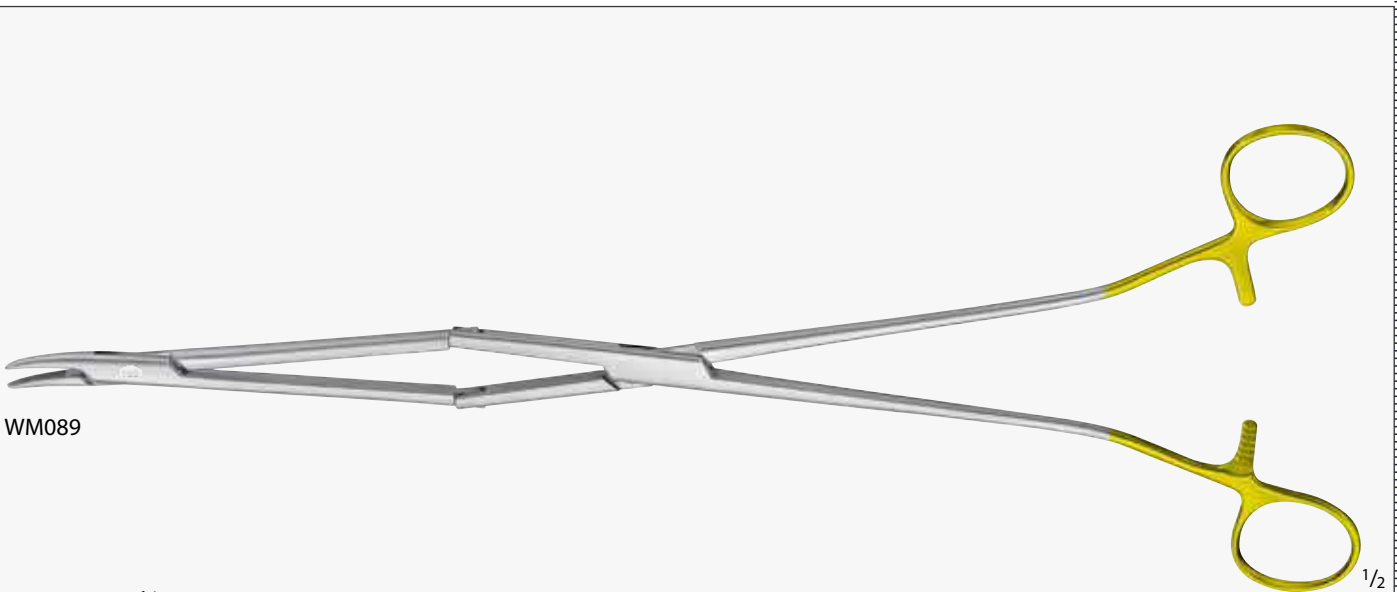

WM089

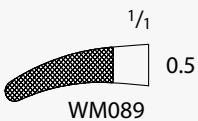

DUROGRIP TC MUELLER Needle Holder

Catalog Number	Tip	Jaw	Length (in.)
WM089	CVD	SERR	14 1/4

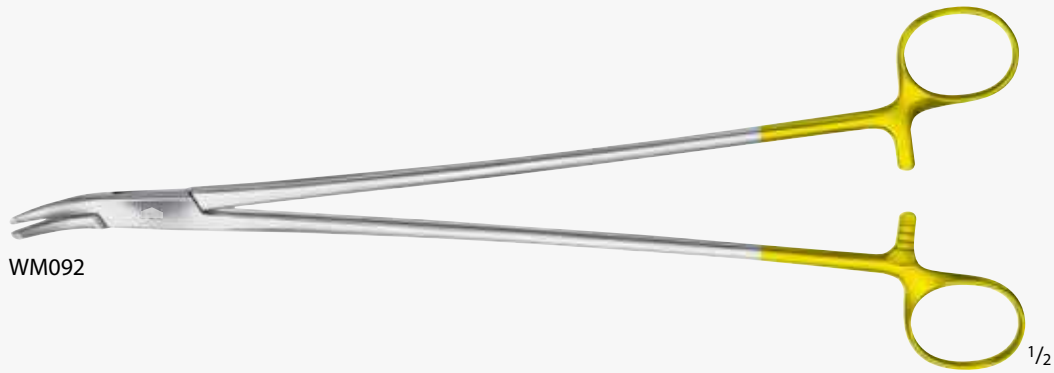

WM092

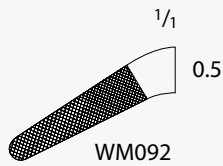

WM092

DUROGRIP TC FINOCHIETTO Needle Holder

Catalog Number	Tip	Jaw	Length (in.)
WM092	ANG	SERR	10 1/2

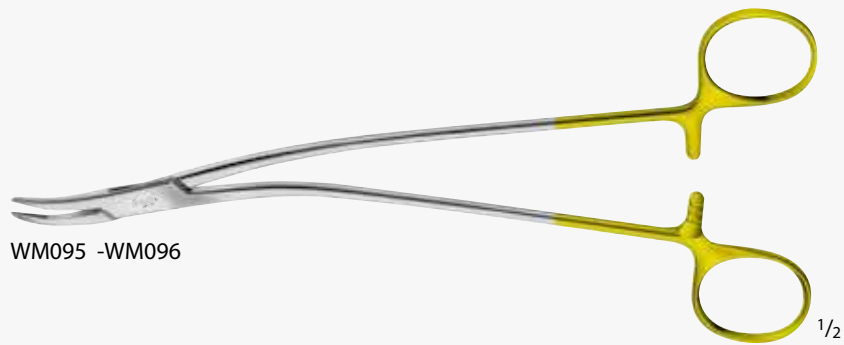

WM095 -WM096

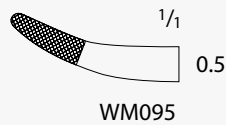

WM095

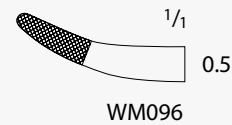

WM096

DUROGRIP TC STRATTE Needle Holder

Catalog Number	Tip	Jaw	Length (in.)
WM095	CVD	SERR	8 1/4
WM096	CVD	SERR	9

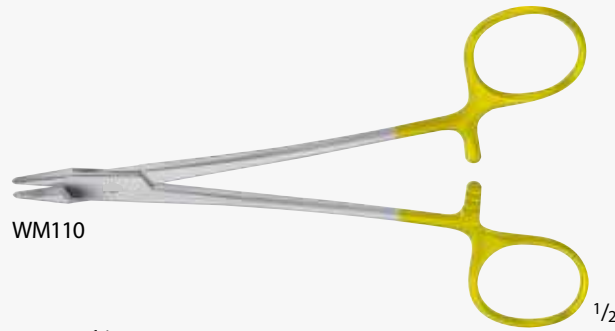

WM110

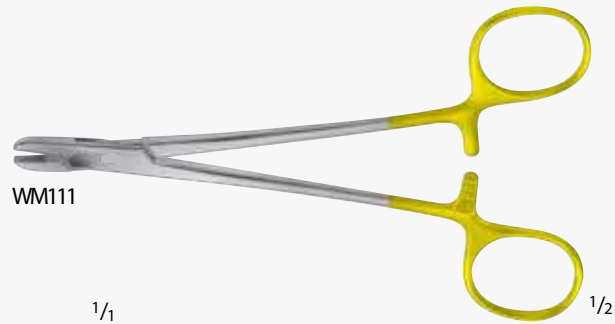
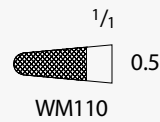

WM111

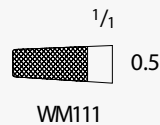

DUROGRIP TC Wire Twister

Catalog Number	Tip	Jaw	Length (in.)
WM110	ROUND	SERR	6 1/8
WM111	SQUARE	SERR	6

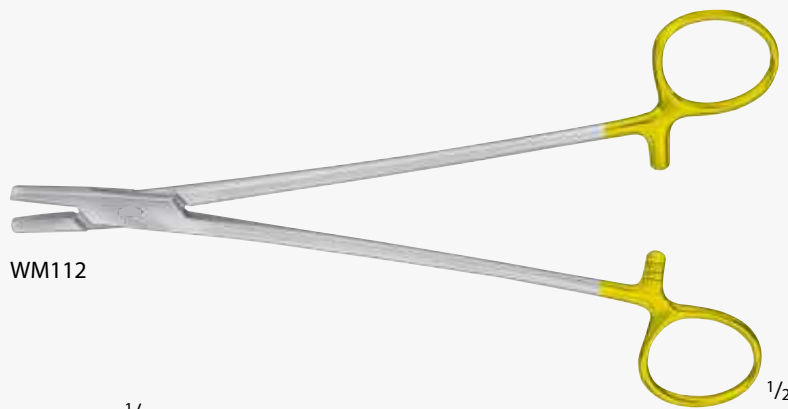

WM112

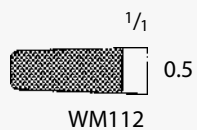

DUROGRIP TC BAUMGARTNER Wire Twister

Catalog Number	Tip	Jaw	Length (in.)
WM112	SQUARE	SERR	7 7/8



WM456

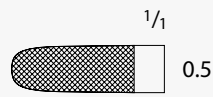

WM456

DUROGRIP TC BERRY Sternal Wire Twister

Catalog Number	Tip	Jaw	Length (in.)
WM456	ROUND	SERR	7 1/4



WM550

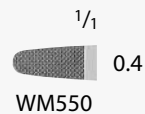

WM550

DUROGRIP TC RUBIO Wire Twister

Catalog Number	Tip	Jaw	Length (in.)
WM550	ROUND	SERR	5



WM149 -WM154

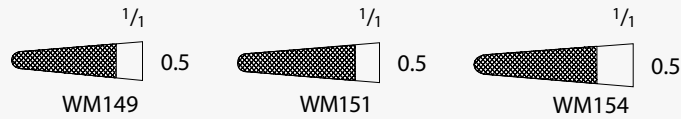

DUROGRIP TC MATHIEU Needle Holder

Catalog Number	Jaw	Length (in.)
WM149	SERR	5 1/2
WM151	SERR	6 1/2
WM154	SERR	7 7/8

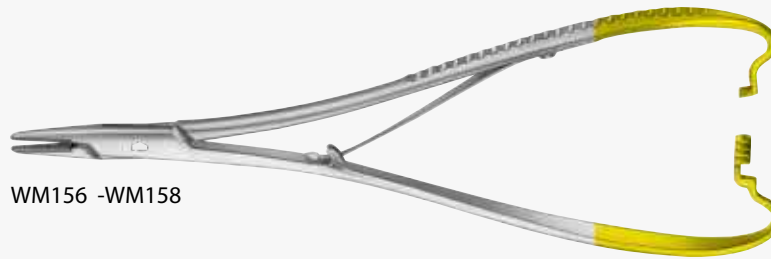

WM156 -WM158



DUROGRIP TC MATHIEU Needle Holder, Heavy

Catalog Number	Jaw	Length (in.)
WM156	SERR	7 7/8
WM158	SERR	9 5/8

INCHES

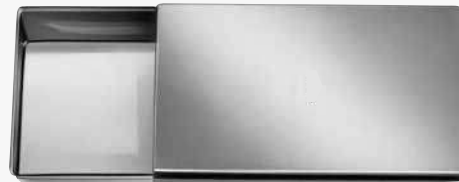

WM907

Needle Case, Rectangle

Catalog Number	Dimensions (mm)
WM907	70 x 53 x 9



WM930 -WM933



WM931 -WM933

Needle Case, Round

Catalog Number	Item	Dimensions (mm)
WM930	COMPLETE NEEDLE CASE W/ INTERIOR BOX	65 x 16
WM931	INTERIOR BOX ONLY	62 x 12
WM933	INTERIOR BOX ONLY	90 x 12



WM941

Needle Case, With 7 Sections

Catalog Number	Dimensions (mm)
WM941	150 x 90 x 10

INCHES



WM749 , WM781 , WM807 , WM809 , WM811 , WM813

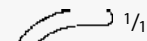
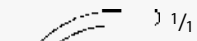
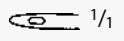
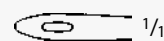
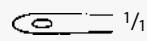
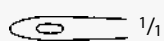
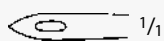
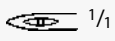

WM781

WM749

WM809

WM807

WM811

WM813



WM822 -WM824

8 1/4  
2 MM

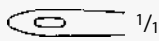

WM822

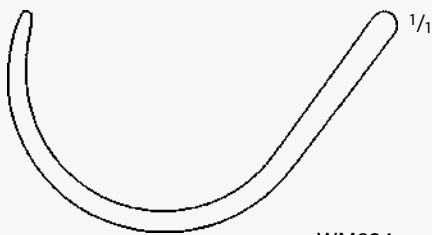

WM824

- WM824
- WM781
- WM749
- WM809
- WM807
- WM811
- WM813

BLUNT,  
2.5 MM 8 1/4

WM807 LEFT

DESCHAMPS Needle

Catalog Number	Hand Orientation	Tip	Length (in.)
WM822	RIGHT	BLUNT, 3.5 MM	
WM824	RIGHT	BLUNT, 5 MM	
WM781	LEFT	SHARP, 2 MM	
WM749	LEFT	SHARP, 3.5 MM	
WM809	LEFT	BLUNT 2.5 MM	
WM807	LEFT	BLUNT 2.5 MM	
WM811	LEFT	BLUNT 3.5 MM	
WM813	LEFT	STEEP,BLUNT 3.5 MM	

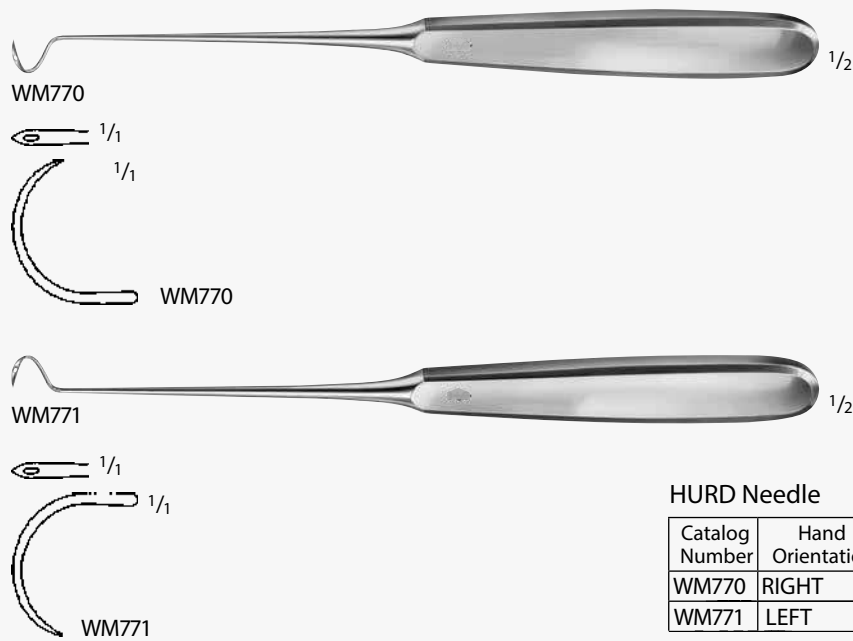

HURD Needle

Catalog Number	Hand Orientation	Tip	Length (in.)
WM770	RIGHT	SHARP	8 1/4
WM771	LEFT	SHARP	8 1/4

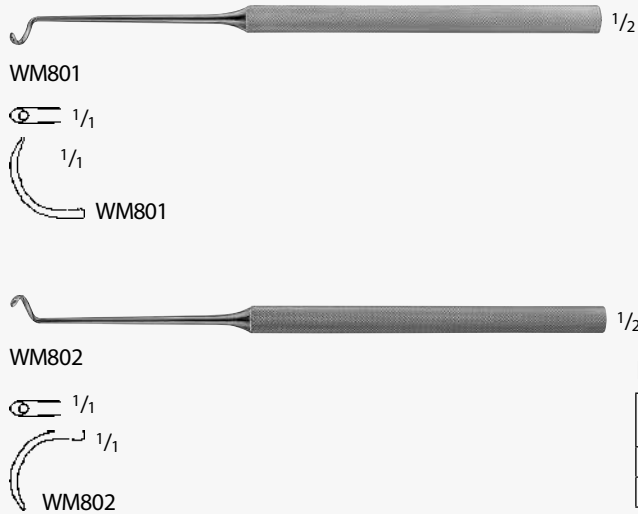

KRONECKER Needle

Catalog Number	Hand Orientation	Tip	Length (in.)
WM801	RIGHT	BLUNT	6 1/8
WM802	LEFT	BLUNT	6 1/8

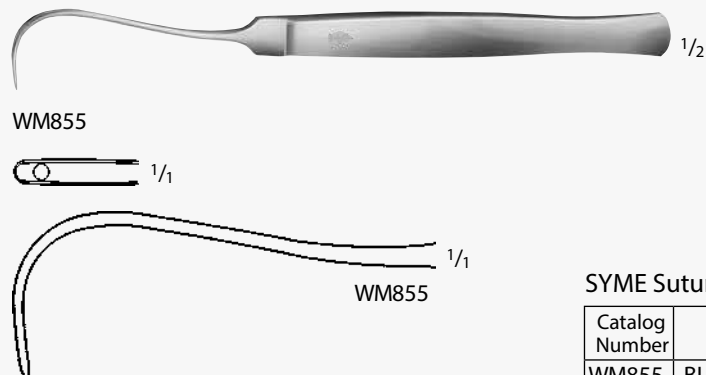

SYME Suture Needle

Catalog Number	Tip	Length (in.)
WM855	BLUNT	6 3/4

INCHES

1

2

3

4

5

6

7

8

9

10

11



350 mm, 13 3/4"

WM033

1/2

1/1

WM033

**Monopolar Diathermy Forceps, Insulated**

Catalog Number	Length (in.)
WM033	13 3/4

WM043 -WM053

1/1

WM043

1/1

WM045

1/1

WM047

1/1

WM049

1/1

WM050

1/1

WM051

1/1

WM052

1/1

WM053

**Dressing Forceps, Standard Patterns**

Catalog Number	Tip	Length (in.)
WM043	SERR	4 1/2
WM045	SERR	5 1/8
WM047	SERR	5 3/4
WM049	SERR	6 1/4
WM050	SERR	7
WM051	SERR	7 7/8
WM052	SERR	9 3/4
WM053	SERR	11 3/4

1/2

WM077

1/1

WM077

**Dressing Forceps, Extra Wide**

Catalog Number	Tip	Length (in.)
WM077	SERR	5 3/4



WM023 -WM033

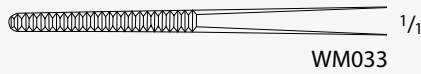

WM035 -WM037

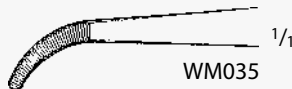

Dressing Forceps, Delicate

Catalog Number	Tip	Length (in.)
WM023	STR, SERR	4 1/2
WM025	STR, SERR	5 1/8
WM027	STR, SERR	5 3/4
WM029	STR, SERR	6 1/4
WM033	STR, SERR	12
WM035	CVD, SERR	5 1/8
WM037	CVD, SERR	5 1/2



WM210



Dressing Forceps, Extra Delicate

Catalog Number	Tip	Length (in.)
WM210	SERR	4 1/2

INCHES

WM575 -WM581

WM575      WM577      WM579      WM580

WM581

WM587 -WM591

WM587      WM589      WM591

WM527

WM527

WM533 -WM543

WM533      WM535      WM537      WM539      WM540      WM541      WM542      WM543

WM803

WM803

Tissue Forceps, Delicate

Catalog Number	Tip	Teeth	Length (in.)
WM533	STR	1 x 2	4 1/2
WM535	STR	1 x 2	5 1/8
WM537	STR	1 x 2	5 3/4
WM539	STR	1 x 2	6 1/4
WM540	STR	1 x 2	7
WM541	STR	1 x 2	7 7/8
WM542	STR	1 x 2	9 3/4
WM543	STR	1 x 2	11 3/4
WM803	STR	2 x 3	4 1/2
WM575	STR	2 x 3	5 1/8
WM577	STR	2 x 3	5 3/4
WM579	STR	2 x 3	6 1/4
WM580	STR	2 x 3	7
WM581	STR	2 x 3	7 7/8
WM587	STR	3 x 4	5 3/4
WM589	STR	3 x 4	6 1/4
WM591	STR	3 x 4	7 7/8
WM527	CVD	1 x 2	5 3/4

Tissue Forceps, Medium

Catalog Number	Teeth	Length (in.)
WM547	1 x 2	5 3/4
WM549	1 x 2	6 1/4

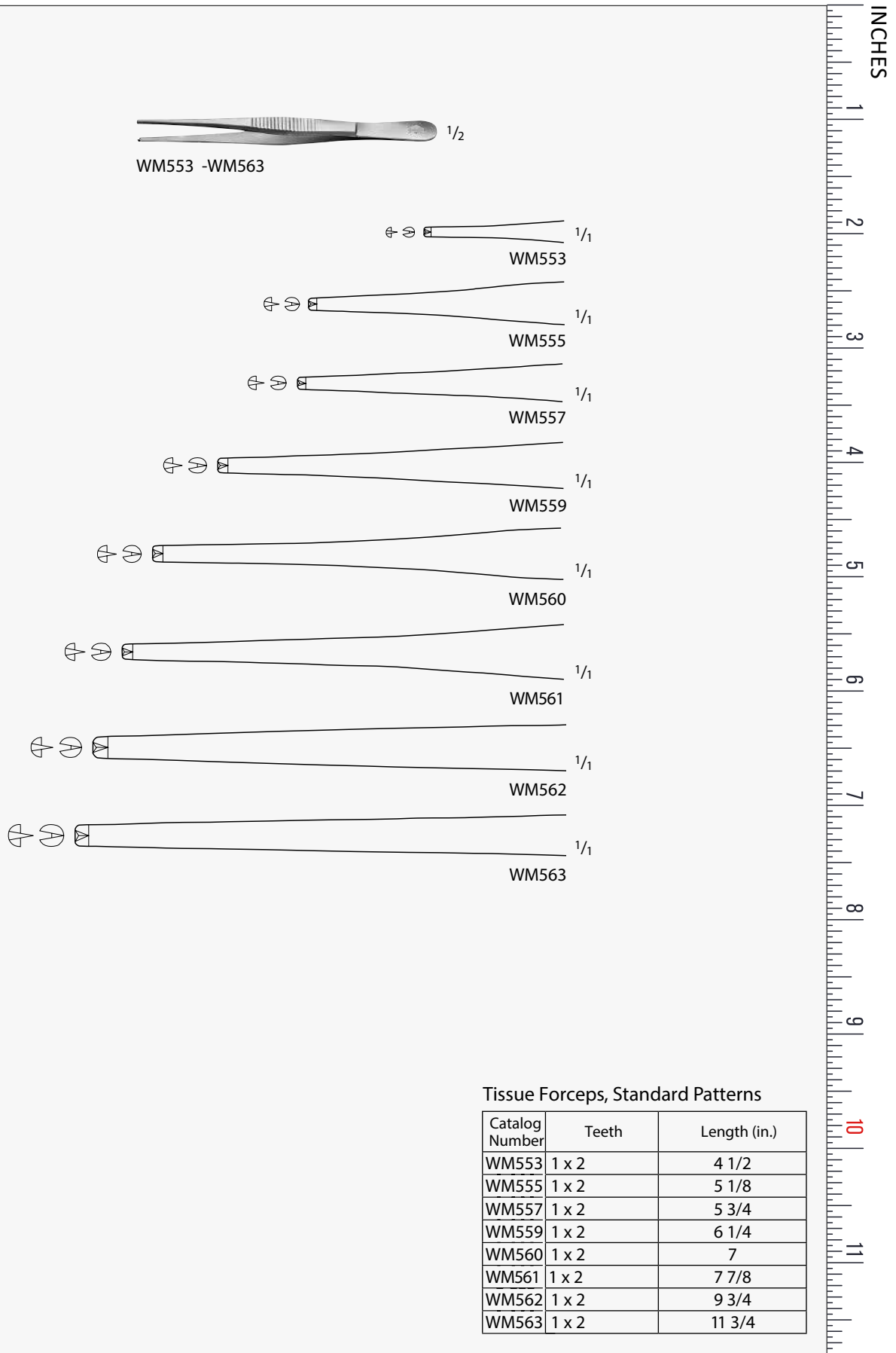

Tissue Forceps, Standard Patterns

Catalog Number	Teeth	Length (in.)
WM553	1 x 2	4 1/2
WM555	1 x 2	5 1/8
WM557	1 x 2	5 3/4
WM559	1 x 2	6 1/4
WM560	1 x 2	7
WM561	1 x 2	7 7/8
WM562	1 x 2	9 3/4
WM563	1 x 2	11 3/4



WM690 -WM692

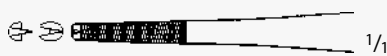

WM690

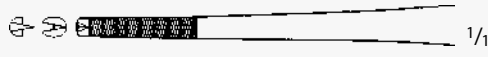

WM692

STRASSBURGER Tissue Forceps

Catalog Number	Tip	Teeth	Length (in.)
WM690	X-SERR	1 x 2	6
WM692	X-SERR	1 x 2	7 7/8

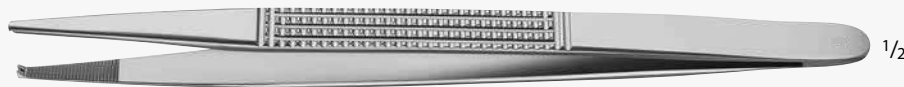

WM077



WM077

CURTIS Tissue Forceps

Catalog Number	Tip	Length (in.)
WM077	SERR	8 3/4



WM693



WM693



WM357



WM357

BONNEY Tissue Forceps

Catalog Number	Tip	Teeth	Length (in.)
WM693	SERR	1 x 2	6 7/8
WM357	SERR	2 x 3	6 3/4



OP733C

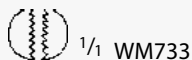

WM733

MARTIN Tissue Forceps

Catalog Number	Teeth	Length (in.)
WM733	7 x 8	6 1/8

INCHES



WM224



WM224



WM464 - WM465



WM464



WM465

HEANEY Tissue Forceps

Catalog Number	Tip	Teeth	Length (in.)
WM464	X-SERR	1 x 2	7 1/4
WM224	X-SERR	2 x 3	5 1/2
WM465	X-SERR	3 x 4	7 1/2



OP725C - OP727C

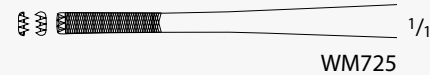

WM725

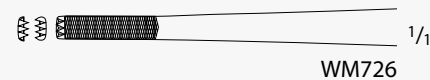

WM726

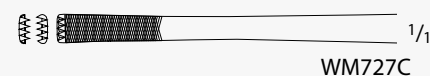

WM727C

STILLE-BARRAYA CV Forceps

Catalog Number	Tip	Teeth	Length (in.)
WM725	X-SERR	3 x 4	7
WM726	X-SERR	3 x 4	7 7/8
WM727	X-SERR	3 x 4	9 3/4



WM760 - WM761 , WM921 - WM922 , WM006

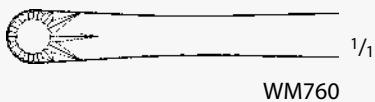

WM760

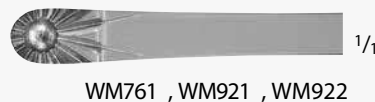

WM761 , WM921 , WM922

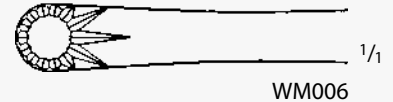

WM006



WM755

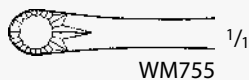

WM755

RUSSIAN Tissue Forceps

Catalog Number	Length (in.)
WM755	6
WM760	7 7/8
WM006	9 3/4
WM761	10 1/4
WM921	12
WM922	14



WM208 -WM923



MAYO-RUSSIAN Tissue Forceps

Catalog Number	Tip	Length (in.)
WM208	FENESTRATED	9
WM923	FENESTRATED	14



WM750

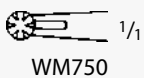

WM750



WM795



WM795

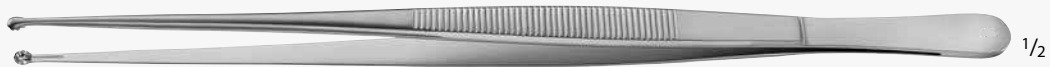

WM078



WM078

SELMAN Tissue Forceps

Catalog Number	Length (in.)
WM750	6 1/8
WM795	7 7/8
WM078	9 3/4

INCHES

1  
2  
3  
4  
5  
6  
7  
8  
9  
10  
11

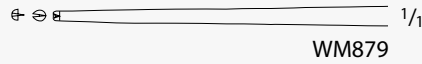
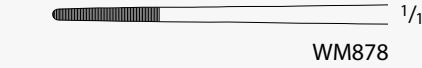

### LUCAE Bayonet Forceps

Catalog Number	Tip	Teeth	Length (in.)
WM878	SERR	-	5 1/2
WM879	SMOOTH	1 x 2	5 1/2

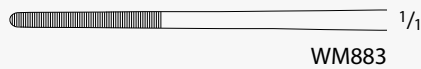

### GRUENWALD Bayonet Forceps

Catalog Number	Tip	Length (in.)
WM883	SERR	7 7/8

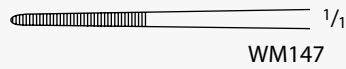

### CUSHING Bayonet Forceps

Catalog Number	Tip	Teeth	Length (in.)
WM147	SERR	-	7 3/4
DP231	SMOOTH	1 x 2	7 1/4



### BROWN-CUSHING Bayonet Forceps

Catalog Number	Teeth	Length (in.)
WM227	7 x 7	7 1/4

INCHES

1

2

3

4

5

6

7

8

9

10

11



WM876 , WM804



WM876 , WM804

**BROWN-BAHNSON Bayonet Forceps**

Catalog Number	Tip	Length (in.)
WM876	SERR	6 1/8
WM804	SERR	8



WM880 , WM236

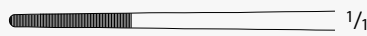

WM880



WM236

**JANSEN Bayonet Forceps**

Catalog Number	Tip	Length (in.)
WM880	SERR	6 1/4
WM236	SERR	6 1/2



WM885

1/2

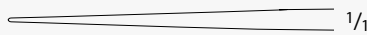

WM885



WM886

1/2

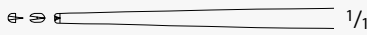

WM886

**Bayonet Forceps**

Catalog Number	Tip	Teeth	Length (in.)
WM885	SMOOTH	-	7 1/4
WM886	SMOOTH	1 x 2	7 7/8



WM104-WM105

1/2



WM105

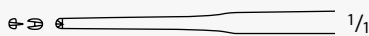

WM104

**GERALD Bayonet Forceps**

Catalog Number	Tip	Teeth	Length (in.)
WM105	SERR	-	7 1/2
WM104	SMOOTH	1 x 2	7 1/2

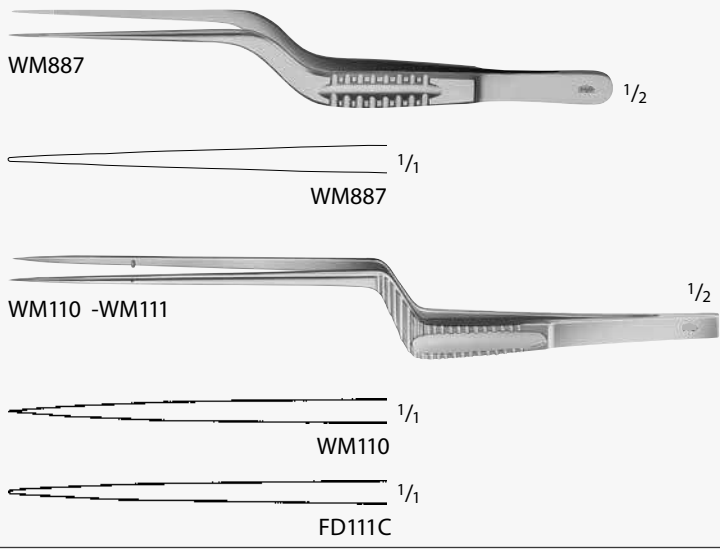

**Bayonet Forceps**

Catalog Number	Tip	Length (in.)
WM887	FINE	6 1/4
WM110	FINE	
WM111	BROAD	7 1/4

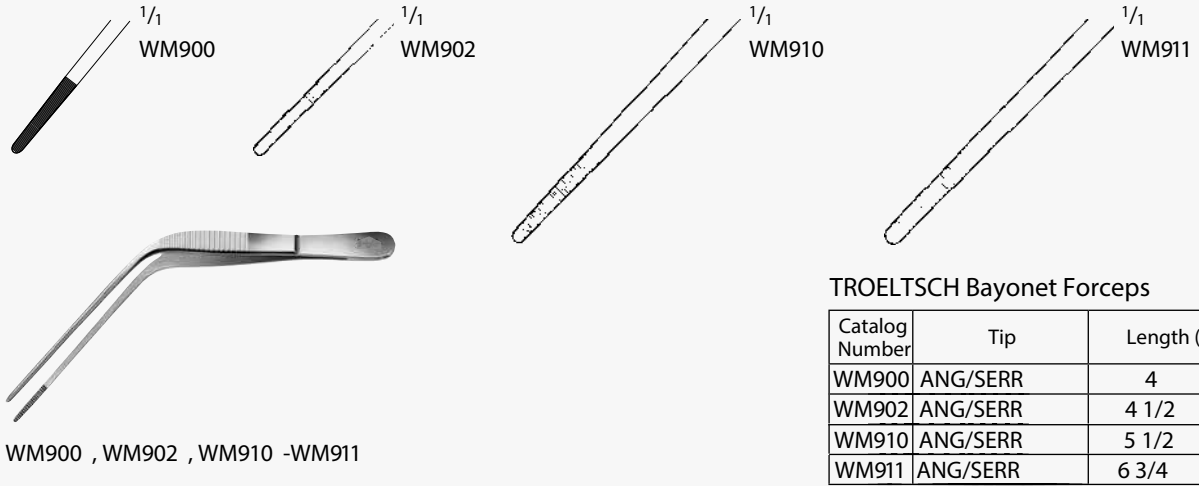

**TROELTSCH Bayonet Forceps**

Catalog Number	Tip	Length (in.)
WM900	ANG/SERR	4
WM902	ANG/SERR	4 1/2
WM910	ANG/SERR	5 1/2
WM911	ANG/SERR	6 3/4

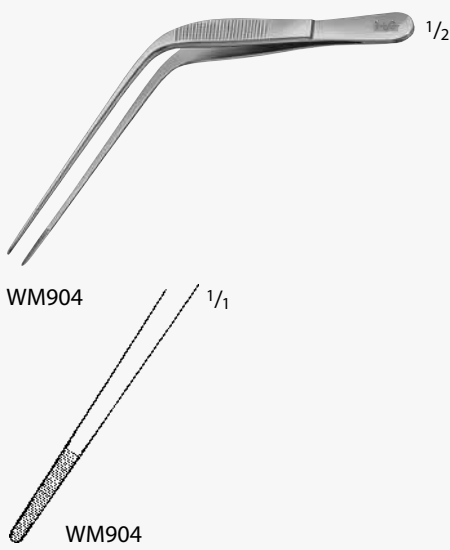

**WILDE Bayonet Forceps**

Catalog Number	Tip	Length (in.)
WM904	ANG/SERR	4 1/2



WWW.WYZZMEDICAL.COM



WM225 , WM291



WM225



WM291

HUDSON Forceps

Catalog Number	Tip	Teeth	Length (in.)
WM225	SERR	-	5
WM291	SMOOTH	1 x 2	5

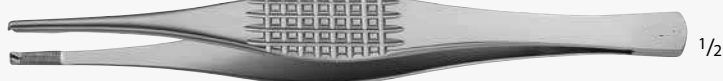

WM610 -WM611



WM610



WM611

FERRIS-SMITH Tissue Forceps

Catalog Number	Tip	Teeth	Length (in.)
WM610	X-SERR	1 x 2	6 7/8
WM611	X-SERR	2 x 3	6 7/8



WM215 -WM216



WM215



WM216



WM665 -WM667



WM665



WM667



WM666C

SEMKEN Forceps, Delicate

Catalog Number	Tip	Teeth	Length (in.)
WM215	SERR	-	5
WM216	SERR	-	6
WM665	SMOOTH	1 x 2	5
WM667	SMOOTH	1 x 2	6
WM666	SMOOTH	2 x 3	5



WM220

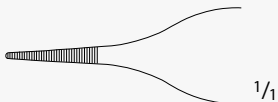

WM220



WM223



WM223

Micro ADSON Forceps, Delicate

Catalog Number	Tip	Length (in.)
WM220	SERR, W/ PLATFORM	4 3/4
WM223	SERR	6



WM222 , WM156

1/2

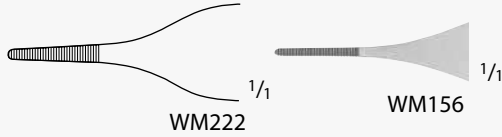

WM222

WM156

1/1

1/1



WM511

1/2



1/1



WM275

1/2

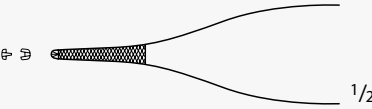

1/2



WM512

1/2

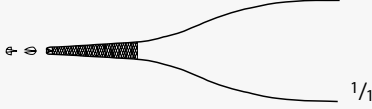

1/1



WM536

1/2

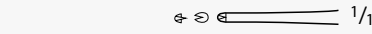

1/1



WM454

1/2



1/1



WM506

1/2

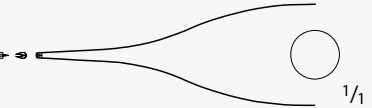

1/1



WM507

1/2



1/1



WM508

1/2



1/1



WM513

1/2



1/1



WM521

1/2



1/1

ADSON Forceps, Delicate

Catalog Number	Tip	Teeth	Handle	Length (in.)
WM222	SERR	-	-	4 3/4
WM156	SERR, X-LONG	-	-	4 3/4
WM511	SMOOTH	1 x 2	-	4 3/4
WM275	SERR	1 x 2	-	4 3/4
WM512	X-SERR W/ PLATFORM	1 x 2	-	4 3/4
WM536	X-LONG	1 x 2	-	4 3/4
WM454	SMOOTH	2 x 3	-	4 3/4
WM506	SMOOTH	1 x 2	FENE-STRATED	4 3/4
WM507	SMOOTH	1 x 2	FENE-STRATED	4 3/4
WM508	SERR	1 x 2	FENE-STRATED	4 3/4
WM513	X-SERR W/ PLATFORM	1 x 2	FENE-STRATED	4 3/4
WM521	SMOOTH	1 x 2	FENE-STRATED	6



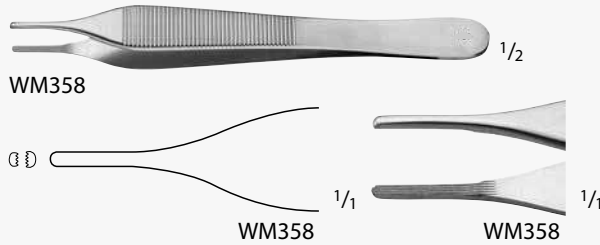

MUSTARDE Suture Removal Forceps

Catalog Number	Tip	Length (in.)
WM358	LONGITUDINAL, SERR	5

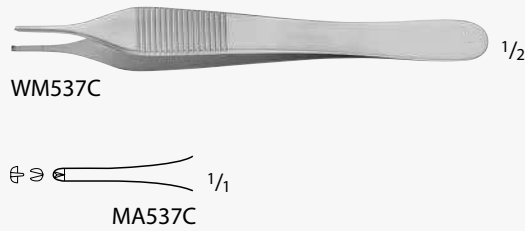

CALLISON-ADSON Tissue Forceps, W/ Platform

Catalog Number	Teeth	Length (in.)
WM537	1 x 2	5

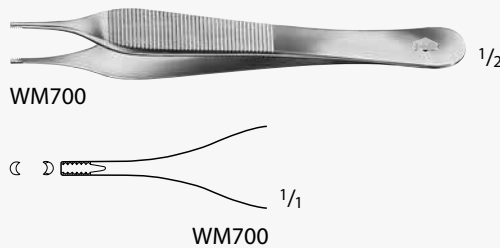

ADSON-BROWN Tissue Forceps

Catalog Number	Teeth	Length (in.)
WM700	7 x 8	4 3/4

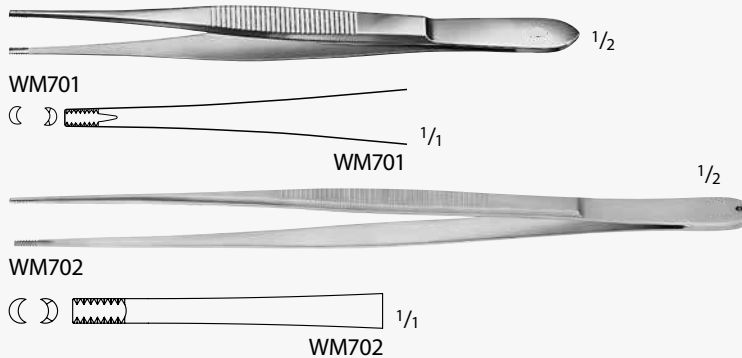

BROWN Tissue Forceps

Catalog Number	Teeth	Length (in.)
WM701	7 x 8	6
WM702	7 x 8	7 7/8

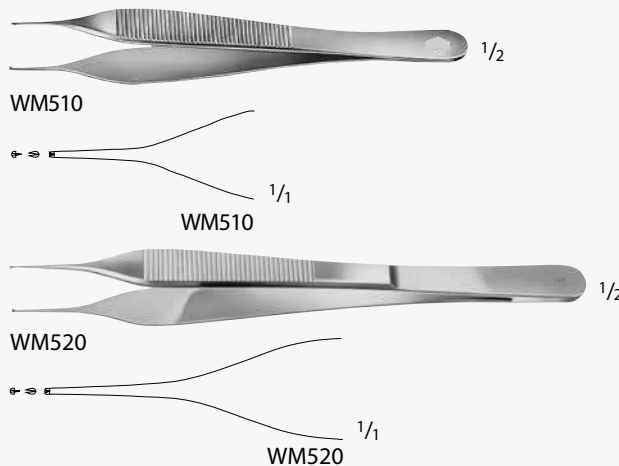

MICRO ADSON Tissue Forceps, Delicate

Catalog Number	Teeth	Length (in.)
WM510	1 x 2	4 3/4
WM520	1 x 2	6



WM662 -WM664

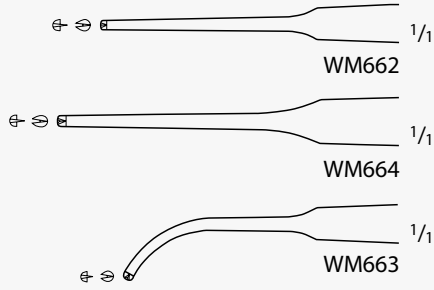

**GERALD Tissue Forceps, Delicate**

Catalog Number	Tip	Teeth	Length (in.)
WM662	STR	1 x 2	6 7/8
WM664	STR	1 x 2	9
WM663	CVD	1 x 2	6 7/8



WM422

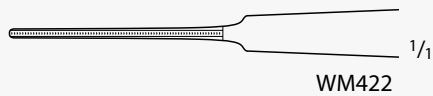

**GERALD-DEBAKEY Forceps, Narrow**

Catalog Number	Tip	Length (in.)
WM422	SERR	9



WM522

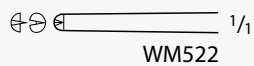

**ADSON Tissue Forceps, Delicate**

Catalog Number	Teeth	Length (in.)
WM522	1 x 2	7



WM523

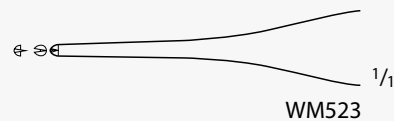

**JEFFERSON Tissue Forceps, Delicate**

Catalog Number	Teeth	Length (in.)
WM523	1 x 2	7



WM228 -WM230

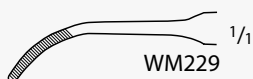
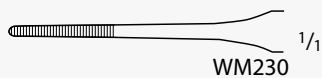
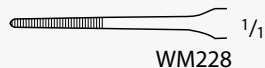

GERALD Dressing Forceps, Delicate

Catalog Number	Tip	Length (in.)
WM228	STR, SERR	6 7/8
WM230	STR, SERR	9
WM229	CVD, SERR	6 7/8



WM236

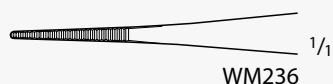

MCINDOE Thumb Forceps, Delicate

Catalog Number	Tip	Length (in.)
WM236	SERR	6



WM661



MCINDOE Tissue Forceps, Delicate

Catalog Number	Tip	Teeth	Length (in.)
WM661	SERR	1 x 2	6



WM257



Delicate Forceps, Angled

Catalog Number	Tip	Length (in.)
WM257	SERR	7 7/8

INCHES





WM238 -WM243



WM238



WM239

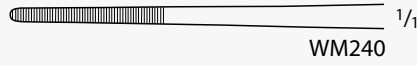

WM240



WM243

CUSHING Forceps, Delicate

Catalog Number	Tip	Length (in.)
WM238	STR, SERR	7
WM239	STR, SERR	7 7/8
WM240	STR, SERR	9 3/4
WM243	CVD, SERR	7 7/8



WM463



WM463

CUSHING Tissue Forceps

Catalog Number	Teeth	Length (in.)
WM463	1 x 2	7



WM246

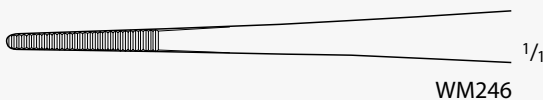

WM246

BROPHY Forceps, Delicate

Catalog Number	Tip	Length (in.)
WM246	SERR	7 7/8



WM231 -WM232

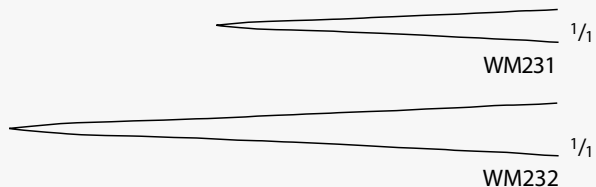

Forceps, Delicate

Catalog Number	Tip	Length (in.)
WM231	SMOOTH	7
WM232	SMOOTH	7 7/8



WM301C -WM305

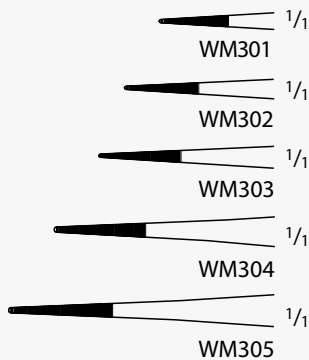

WM311 -WM315

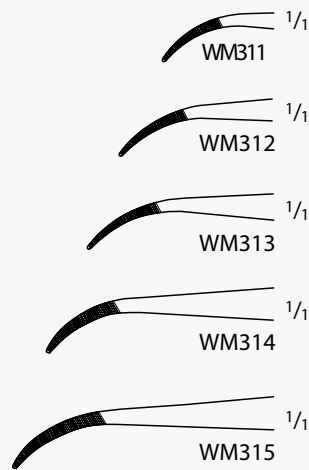

Micro Dressing Forceps

Catalog Number	Tip	Length (in.)
WM301	STR, SERR	3 1/2
WM302	STR, SERR	4 1/8
WM303	STR, SERR	4 1/2
WM304	STR, SERR	5 1/8
WM305	STR, SERR	5 3/4
WM311	CVD, SERR	3 1/2
WM312	CVD, SERR	4 1/8
WM313	CVD, SERR	4 1/2
WM314	CVD, SERR	5 1/8
WM315	CVD, SERR	5 3/4





WM500

1/2

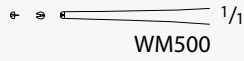

WM500

1/1



WM501

1/2

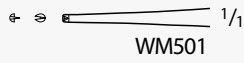

WM501

1/1



WM502

1/2

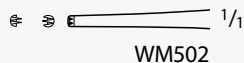

WM502

1/1

Micro Tissue Forceps

Catalog Number	Teeth	Length (in.)
WM500	1 x 2	4
WM501	1 x 2	4 1/4
WM502	2 x 3	4 1/4



WM335

1/2



WM335

1/1

Micro Forceps #3 Jewelers

Catalog Number	Tip Size (mm)	Length (in.)
WM335	0.3	5 1/4



WM330

1/2



WM330

1/1

Micro Forceps #4 Jewelers

Catalog Number	Tip Size (mm)	Length (in.)
WM330	0.2	4 1/4



WM331

1/2



WM331

1/1

Micro Forceps #5 Jewelers

Catalog Number	Tip Size (mm)	Length (in.)
WM331	0.15	4 1/4



WM333

1/2



WM333

1/1

Micro Forceps #7 Jewelers

Catalog Number	Tip Size (mm)	Length (in.)
WM333	0.2	4 1/2

INCHES

1

2

3

4

5

6

7

8

9

10

11



WM660



WM660

GILLIES Tissue Forceps, Delicate

Catalog Number	Tip	Teeth	Length (in.)
WM660	X-SERR	1 x 2	6 1/8



WM669



WM669

SEMKEN Tissue Forceps, Delicate

Catalog Number	Teeth	Length (in.)
WM669	1 x 2	5 3/4



WM670C -WM679

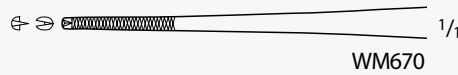

WM670

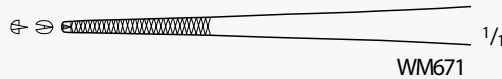

WM671

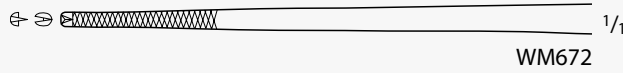

WM672

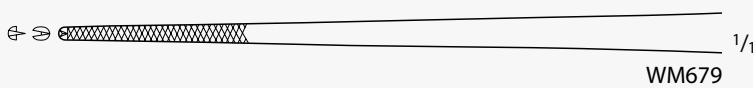

WM679

WAUGH Tissue Forceps, Delicate

Catalog Number	Tip	Teeth	Length (in.)
WM670	X-SERR	1 x 2	7
WM671	X-SERR	1 x 2	7 7/8
WM672	X-SERR	1 x 2	9 3/4
WM679	X-SERR	1 x 2	12



WM211



WM211

DOCKTOR Forceps

Catalog Number	Tip	Teeth	Length (in.)
WM211	X-SERR	1 x 2	4 3/4

**DEBAKEY Atraumatic Ultra Light Forceps**

Catalog Number	Tip Size (mm)	Length (in.)
WM411	1.2	6
WM412	1.5	7 7/8
WM413	1.5	9 1/2
WM418	1.5	11 3/4

**DEBAKEY Atraumatic Vascular Tissue Forceps**

Catalog Number	Tip Size (mm)	Length (in.)
WM394	1	6
WM395	1	7 3/4
WM396	1	9 1/2

**DEBAKEY Atraumatic Forceps**

Catalog Number	Tip Size (mm)	Length (in.)
WM411	1.5	6
WM412	1.5	7 7/8
WM418	1.5	9 1/2
WM419	1.5	11 3/4





WWW.WYZZMEDICAL.COM



WM400 -WM409

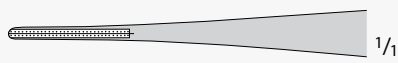

WM400



WM402



WM404



WM405



WM414



WM415

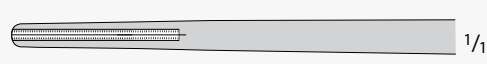

WM416

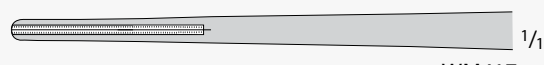

WM417

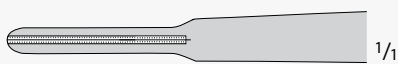

WM406

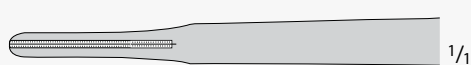

WM407



WM408



WM409



DEBAKEY Atraumatic Forceps

Catalog Number	Tip Size (mm)	Length (in.)
WM400	2	6
WM402	2	7 7/8
WM404	2	9 1/2
WM405	2	11 3/4
WM414	2.8	6
WM415	2.8	7 7/8
WM416	2.8	9 1/2
WM417	2.8	11 3/4
WM406	3.5	7 7/8
WM407	3.5	9 1/2
WM408	3.5	11 3/4
WM409	3.5	13 3/4



WM401 -WM410

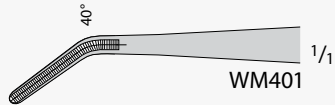

WM401

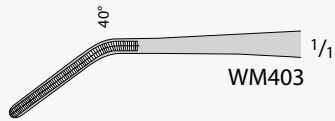

WM403

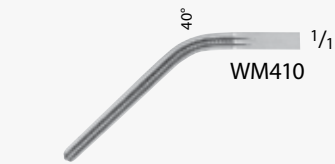

WM410

DEBAKEY Atraumatic Forceps, Angled

Catalog Number	Tip Size (mm)	Length (in.)
WM401	2	6
WM403	2	7 7/8
WM410	2	9 1/2



WM786



WM786



WM785



WM785



WM784



WM784

COOLEY Atraumatic Vascular Tissue Forceps

Catalog Number	Tip Size (mm)	Length (in.)
WM784	1.5	6
WM785	2.0	7 3/4
WM786	2.3	9 1/2



WM250



WM250

COOLEY Vascular Tissue Forceps

Catalog Number	Length (in.)
WM250	7 7/8



WM770

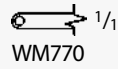

WM770

MILLS Mammary/Coronary Tissue Forceps

Catalog Number	Length (in.)
WM770	7



WM130

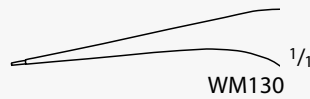

WM130

Dilator Forceps

Catalog Number	Tip Size (mm)	Length (in.)
WM130	0.2	4 1/2



WM980



WM980

HUNTER Splinter Forceps

Catalog Number	Length (in.)
WM980	4 1/8

INCHES

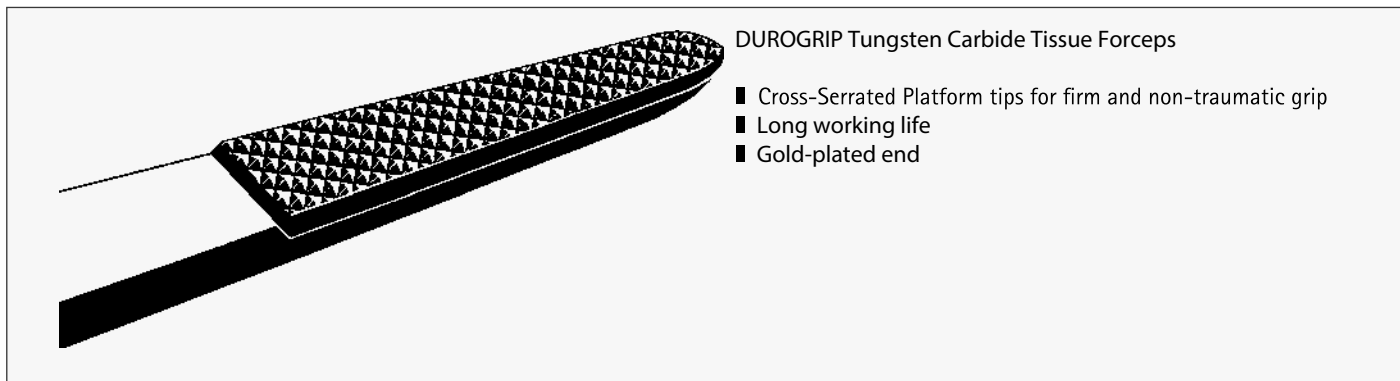

DUROGRIP Tungsten Carbide Tissue Forceps

- Cross-Serrated Platform tips for firm and non-traumatic grip
- Long working life
- Gold-plated end

WWW.WYZZMEDICAL.COM

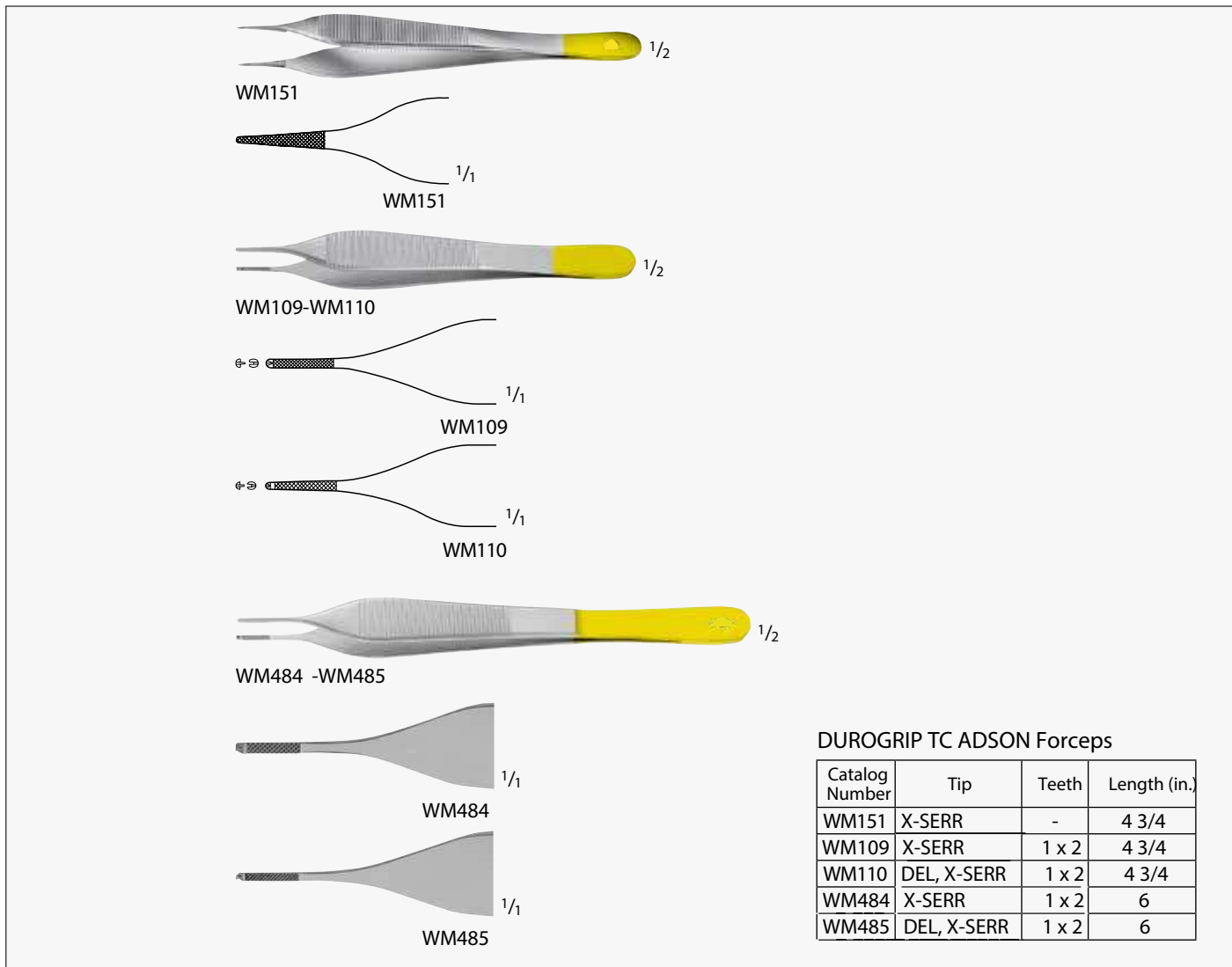

DUROGRIP TC ADSON Forceps

Catalog Number	Tip	Teeth	Length (in.)
WM151	X-SERR	-	4 3/4
WM109	X-SERR	1 x 2	4 3/4
WM110	DEL, X-SERR	1 x 2	4 3/4
WM484	X-SERR	1 x 2	6
WM485	DEL, X-SERR	1 x 2	6

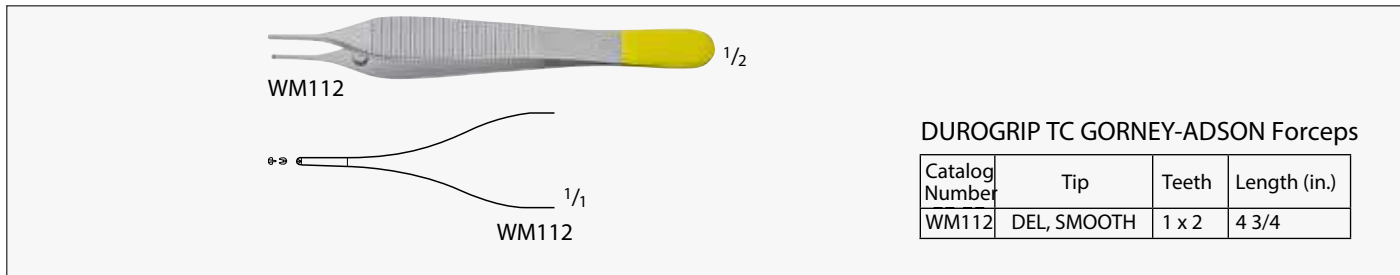

DUROGRIP TC GORNEY-ADSON Forceps

Catalog Number	Tip	Teeth	Length (in.)
WM112	DEL, SMOOTH	1 x 2	4 3/4

INCHES

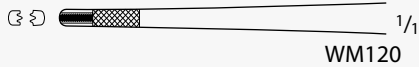
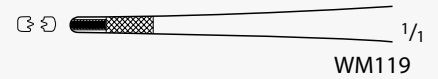

DUROGRIP TC DEBAKEY Needle Forceps

Catalog Number	Tip	Tip Size (mm)	Length (in.)
WM119	NARROW	1.5	7 3/4
WM117	-	2	6
WM118	-	2	8
WM120	NARROW	2	9



GERALD Needle Forceps

Catalog Number	Tip	Teeth	Length (in.)
WM356	X-SERR	1 x 2	6 7/8

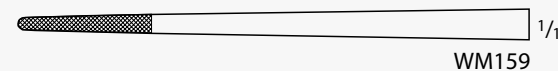
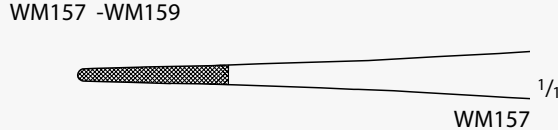
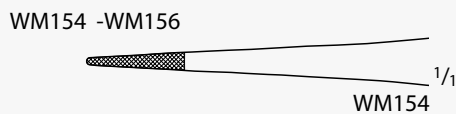

DUROGRIP TC (POTTS-SMITH) Thumb Forceps

Catalog Number	Tip	Length (in.)
WM154	X-SERR	5 3/4
WM156	X-SERR	7
WM157	X-SERR	7 7/8
WM158	X-SERR	9
WM159	X-SERR	9 3/4

1  
2  
3  
4  
5  
6  
7  
8  
9  
10  
11



WM160 -WM198

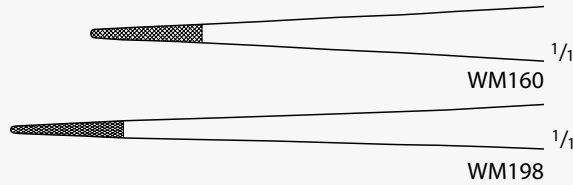

DUROGRIP TC CUSHING Forceps,  
W/ Scraper End

Catalog Number	Tip	Length (in.)
WM160	X-SERR	7
WM198	X-SERR	9 3/4



WM308



DUROGRIP TC CUSHING Forceps

Catalog Number	Tip	Length (in.)
WM308	ANG, X-SERR	6 1/4



WM111



DUROGRIP TC SEMKEN Forceps

Catalog Number	Tip	Tip Size (mm)	Teeth	Length (in.)
WM111	X-SERR	1	1 x 2	6 1/4



WM164 - WM166

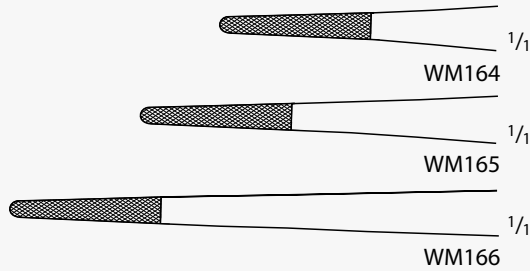

DUROGRIP TC STANDARD Forceps

Catalog Number	Tip	Length (in.)
WM164	X-SERR	5 3/4
WM165	X-SERR	7 7/8
WM166	X-SERR	9 3/4



WM168

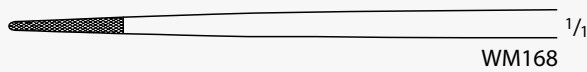

DUROGRIP TC GRUENWALD Forceps

Catalog Number	Tip	Length (in.)
WM168	X-SERR	7 1/4



WM171 - WM173

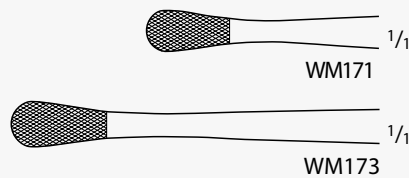

DUROGRIP TC WANGENSTEEN Forceps

Catalog Number	Tip	Length (in.)
WM171	X-SERR	6
WM173	X-SERR	9



WM309

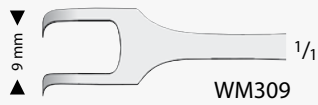
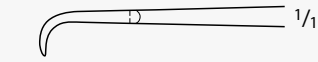

WM309

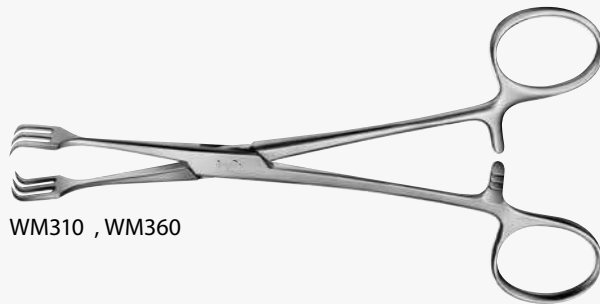

WM310 , WM360

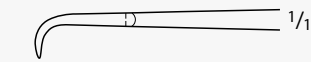

WM310 , WM360

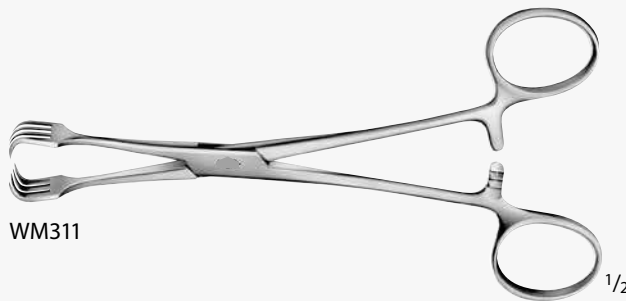

WM311

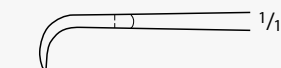

WM311



LAHEY Forceps

Catalog Number	Teeth	Length (in.)
WM309	2 x 2	6 1/8
WM310	3 x 3	6 1/8
WM360	3 x 3	8
WM311	4 x 4	6 1/8



WM010

**BOYS-ALLIS Forceps**

Catalog Number	Teeth	Length (in.)
WM010	5 x 6	6 1/8



WM010

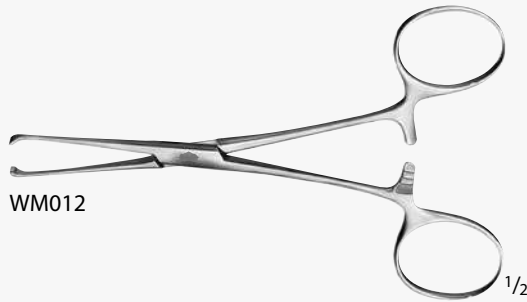

WM012

**Baby ALLIS Forceps**

Catalog Number	Teeth	Length (in.)
WM012	4 x 5	5 1/8



WM012

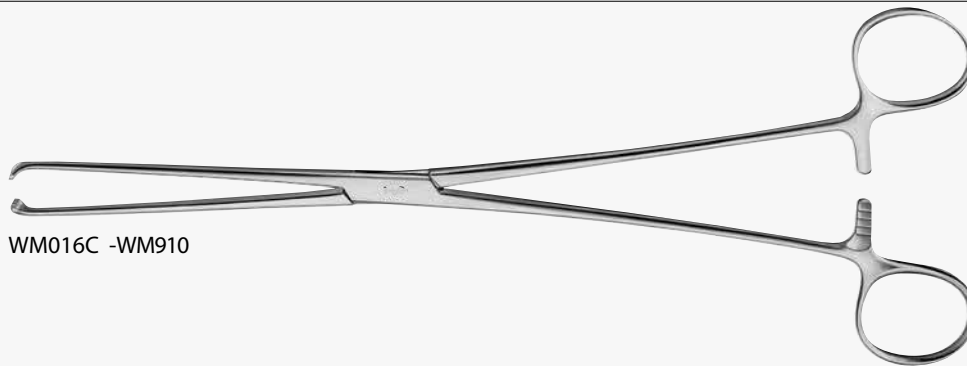

WM016C - WM910

**ALLIS Forceps**

Catalog Number	Teeth	Length (in.)
WM015	4 x 5	6 1/8
WM016	5 x 6	6 1/8
WM017	5 x 6	7 1/2
WM938	5 x 6	8 3/4
WM018	5 x 6	10
WM910	5 x 6	16



WM015



WM015

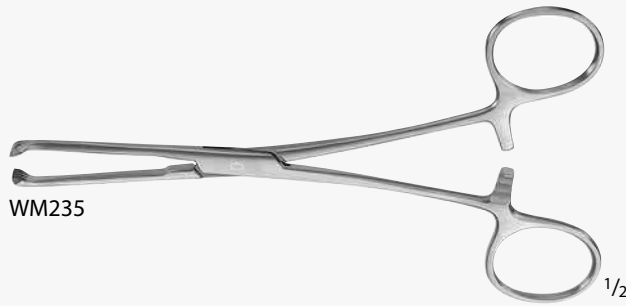

WM235

1/2



WM235

1/1



WM236 -WM237

1/2

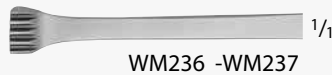

WM236 -WM237

1/1

ALLIS Forceps, Heavy Version

Catalog Number	Teeth	Length (in.)
WM235	4 x 5	6 1/8
WM236	5 x 6	6 1/8
WM237	5 x 6	7 7/8

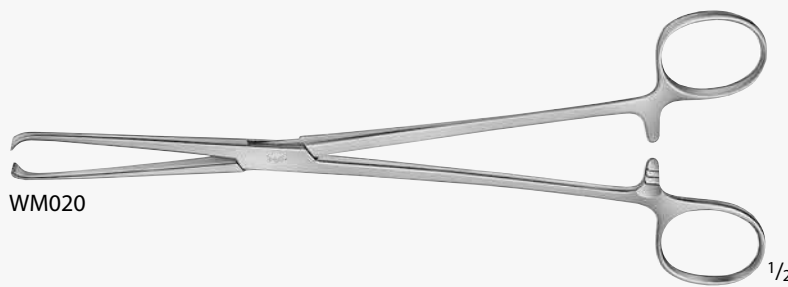

WM020

1/2



WM020

1/1

ALLIS-THOMS Forceps

Catalog Number	Teeth	Length (in.)
WM020	6 x 7	7 7/8

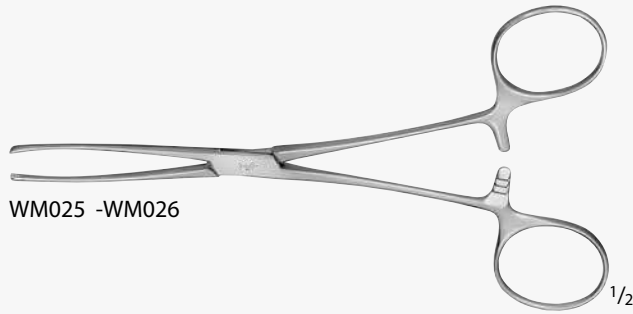

JUDD-ALLIS Forceps

Catalog Number	Teeth	Length (in.)
WM025	3 x 4	6 1/8
WM026	3 x 4	7 7/8

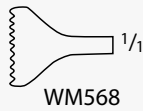
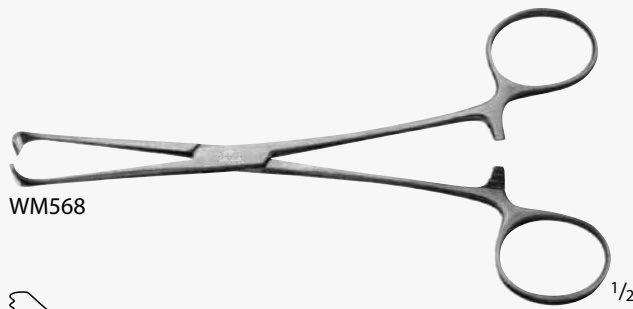

ALLIS-ADAIR Clamp

Catalog Number	Teeth	Length (in.)
WM568	9 x 10	6 1/4

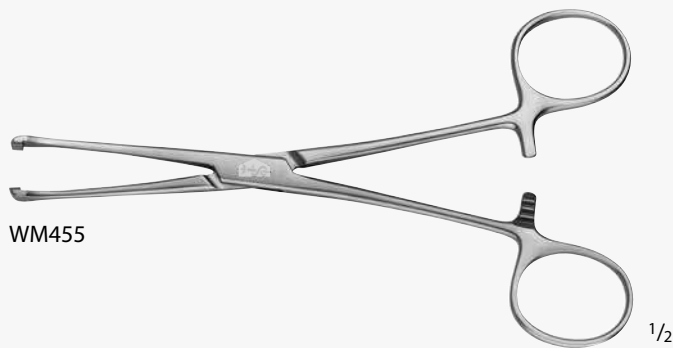

LOCKWOOD-ALLIS Intestinal Clamp

Catalog Number	Teeth	Length (in.)
WM455	4 x 5	6 1/2

INCHES

1  
2  
3  
4  
5  
6  
7  
8  
9  
10  
11



WM092 -WM099

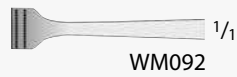

WM092  $\frac{1}{16}$

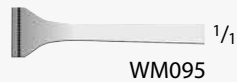

WM095  $\frac{1}{16}$



WM096  $\frac{1}{16}$



WM097  $\frac{1}{16}$



WM099  $\frac{1}{16}$



WM100 -WM101

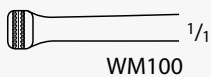

WM100  $\frac{1}{16}$



WM101  $\frac{1}{16}$

ALLIS Atraumatic Forceps

Catalog Number	Length (in.)
WM092	6 1/4
WM095	7 7/8
WM096	8 3/4
WM097	10
WM100	11 5/8
WM099	11 3/4
WM101	14



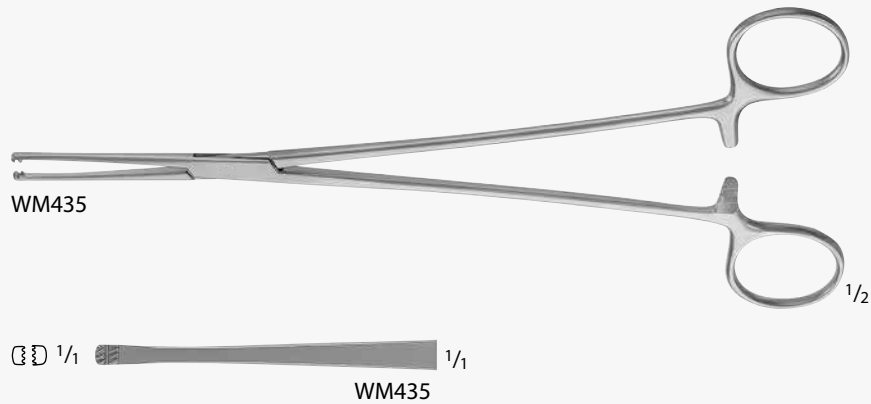

GLASSMAN-ALLIS Common Duct Forceps Non-Crushing

Catalog Number	Length (in.)
WM435	8 1/2

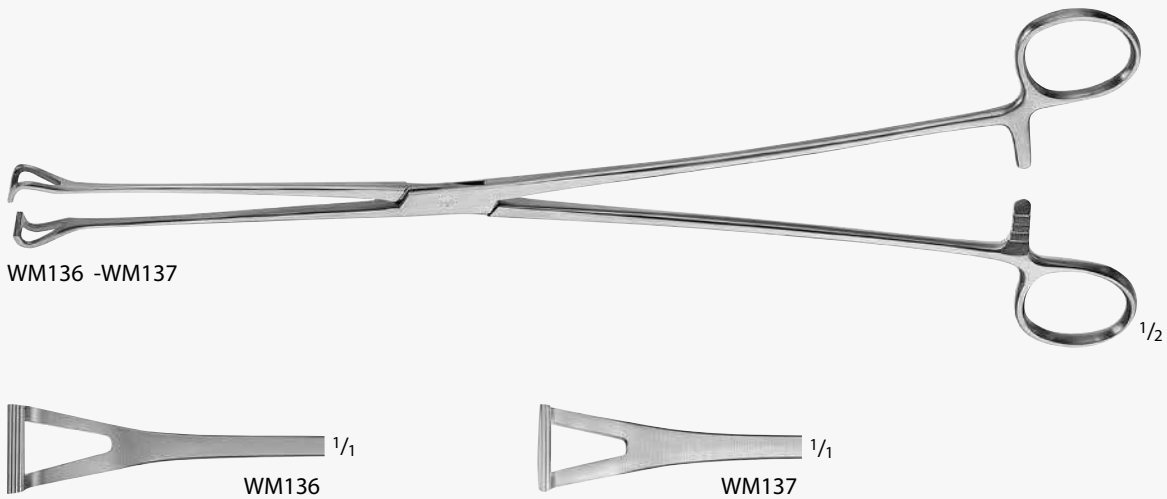

BABCOCK Tissue Holding Forceps

Catalog Number	Length (in.)
WM136	12
WM137	14



WM030 -WM359



WM359



WM030



WM031



WM032

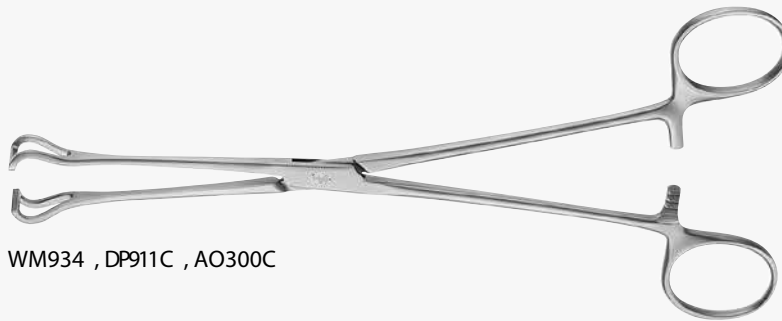

WM934 , DP911C , AO300C



WM934 , WM911 , WM300

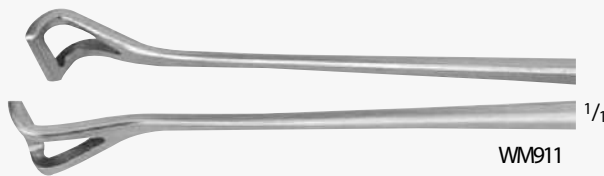

WM911

**BABCOCK Forceps**

Catalog Number	Tip	Length (in.)
WM359	-	5 1/2
WM030	-	6 1/8
WM031	-	6 7/8
WM032	-	8 1/2
WM934	-	8 3/4
WM300	-	14
WM911	DEL, PETITE	16



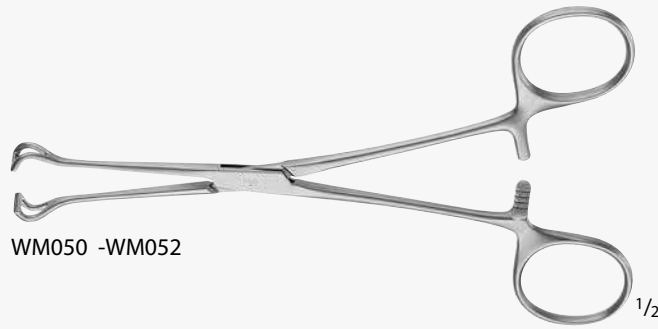

WM050 -WM052

1/2



1/1



1/1

WM050

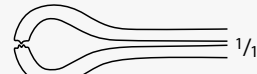

1/1



1/1

WM052



WM936

1/2

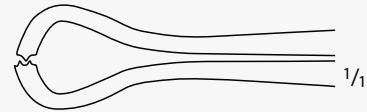

1/1



1/1

WM936

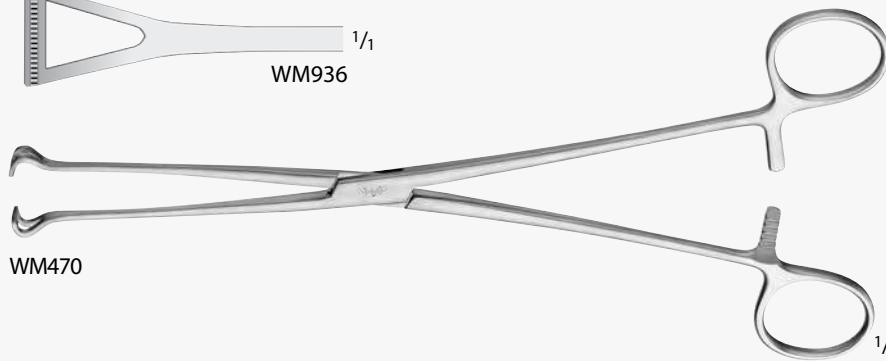

WM470

1/2



1/1



1/1

WM470

BABCOCK Atraumatic Forceps

Catalog Number	Length (in.)
WM050	6 1/4
WM052	8 1/2
WM936	8 3/4
WM470	9 1/2





WM364



WM364



WM338



WM338

DUROGRIP™ TC BABCOCK Forceps

Catalog Number	Length (in.)
WM364	6 1/4
WM338	8 1/4



WM022 - WM023



WM022



WM023

ALLIS Intestinal Grasping Forceps

Catalog Number	Length (in.)
WM022	7 1/2
WM023	11 1/2

INCHES

1

2

3

4

5

6

7

8

9

10

11

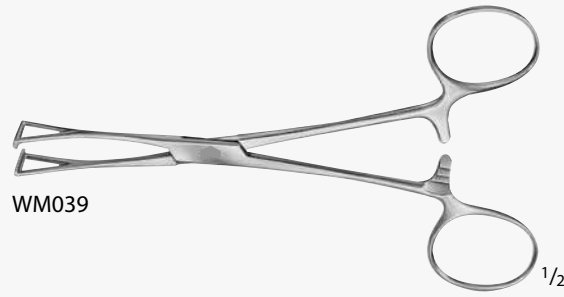

WM039

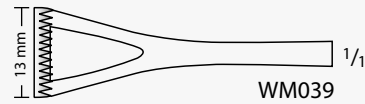

WM039

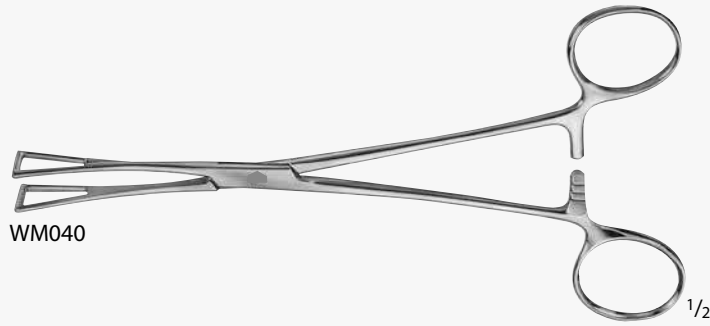

WM040

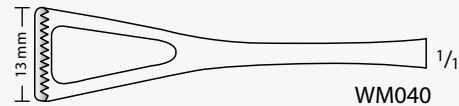

WM040

**COLLIN Intestinal Forceps**

Catalog Number	Length (in.)
WM039	5 1/2
WM040	7

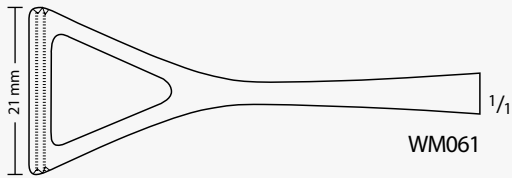

WM061

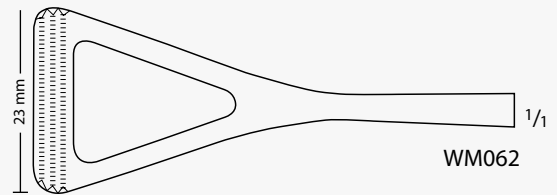

WM062

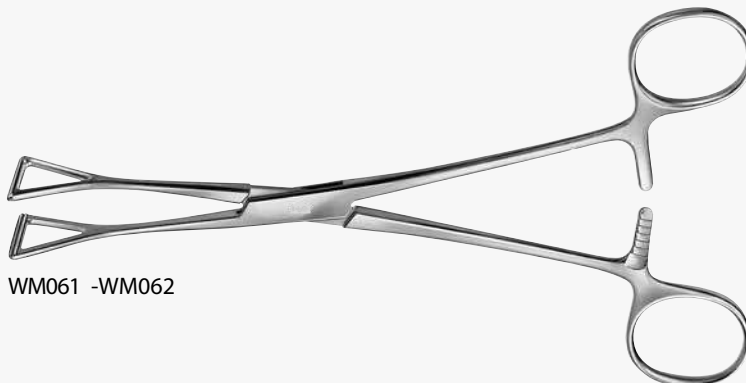

WM061 -WM062

**COLLIN Atraumatic Forceps**

Catalog Number	Length (in.)
WM061	7 3/4
WM062	9

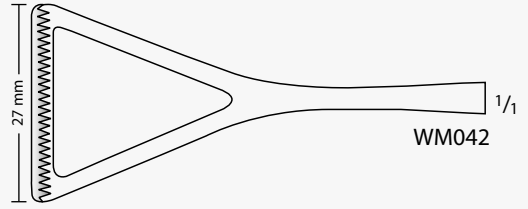
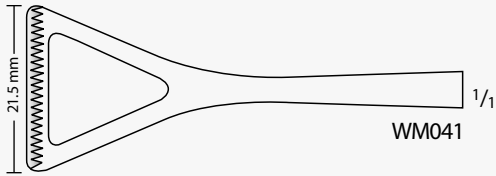

DUVAL-COLLIN Intestinal Forceps

Catalog Number	Length (in.)
WM041	7 3/4
WM042	7 7/8

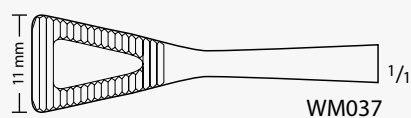
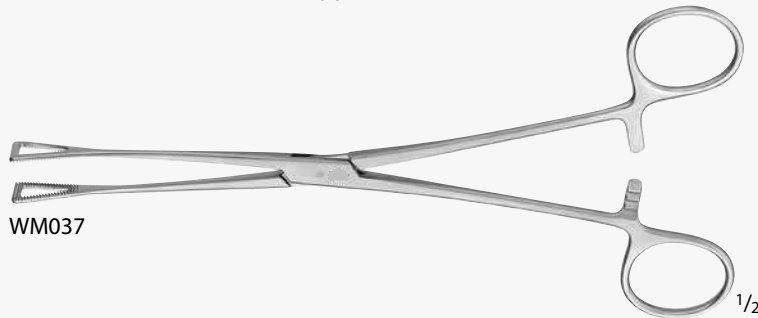
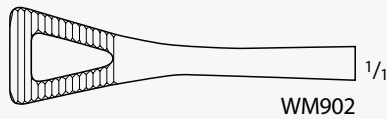
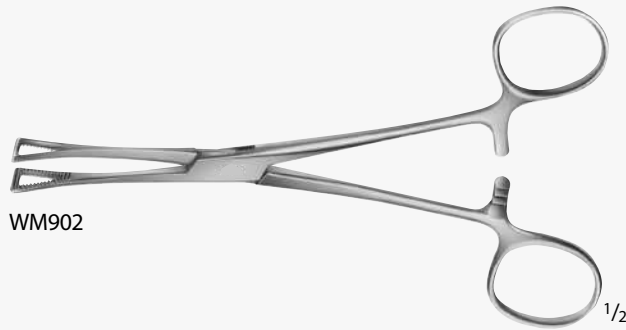

PENNINGTON Forceps

Catalog Number	Length (in.)
WM902	6 1/8
WM037	7 7/8



WM106  $\frac{1}{1}$

WM107  $\frac{1}{1}$

WM114  $\frac{1}{1}$

WM115  $\frac{1}{1}$

WM106 -WM107 , WM114-WM115  $\frac{1}{2}$

**BAINBRIDGE Intestinal Forceps, Longitudinal Serrations**

Catalog Number	Jaw	Length (in.)
WM106	STR	6 1/8
WM114	STR	7 1/4
WM107	CVD	6 1/8
WM115	CVD	7 1/4

WM114  $\frac{1}{2}$

WM114  $\frac{1}{1}$

WM609  $\frac{1}{2}$

WM609  $\frac{1}{1}$

**ALLEN Intestinal Forceps, Longitudinal Serrated**

Catalog Number	Teeth	Length (in.)
WM114	1 x 2	6 1/8
WM609	1 x 2	7 7/8

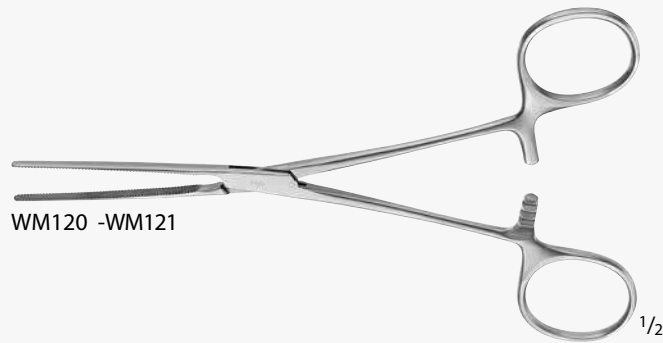

WM120 -WM121



WM120



WM121



WM126 -WM127



WM126

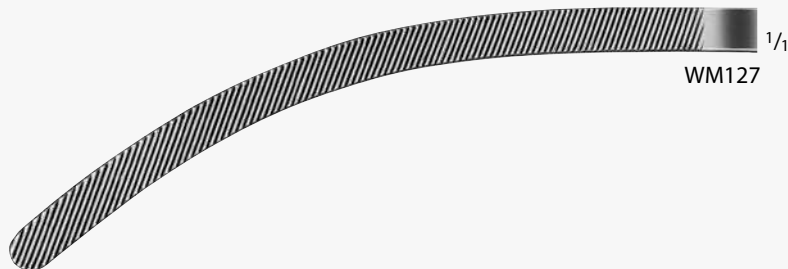

WM127

DOYEN Intestinal Forceps, Elastic Blades

Catalog Number	Jaw	Length (in.)
WM120	STR	6 1/2
WM126	STR	9 1/4
WM121	CVD	6 1/2
WM127	CVD	9 1/4

INCHES

1  
2  
3  
4  
5  
6  
7  
8  
9  
10  
11

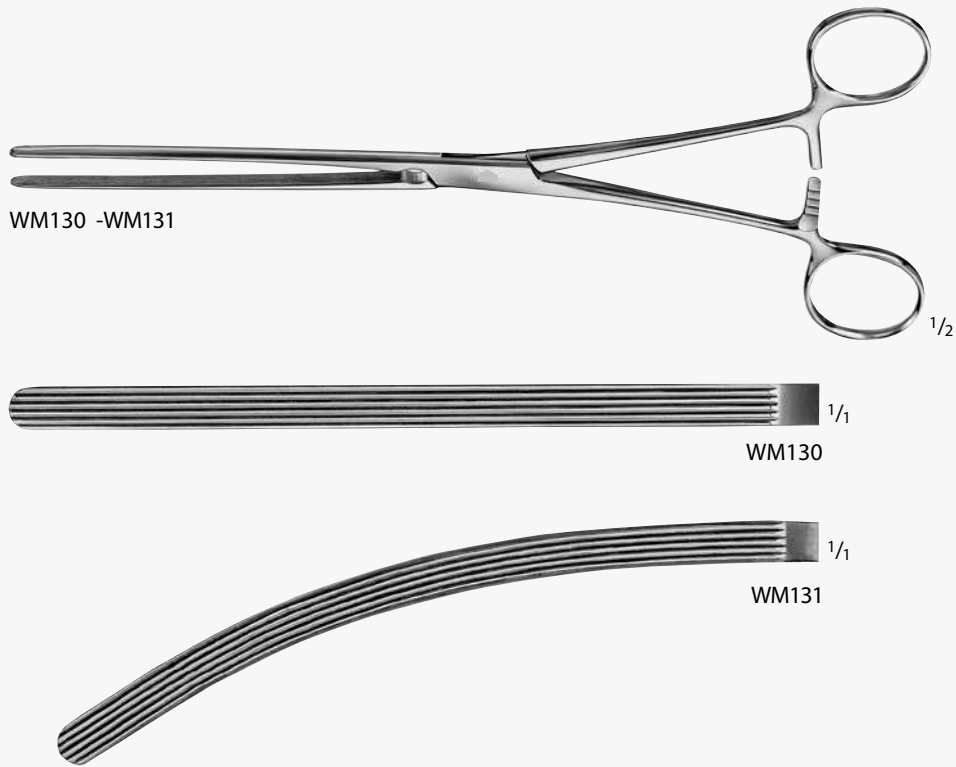

WM130 -WM131

DOYEN Intestinal Forceps, Elastic Blades, Longitudinal Serations

Catalog Number	Jaw	Length (in.)
WM130	STR	9 1/2
WM131	CVD	9 1/2

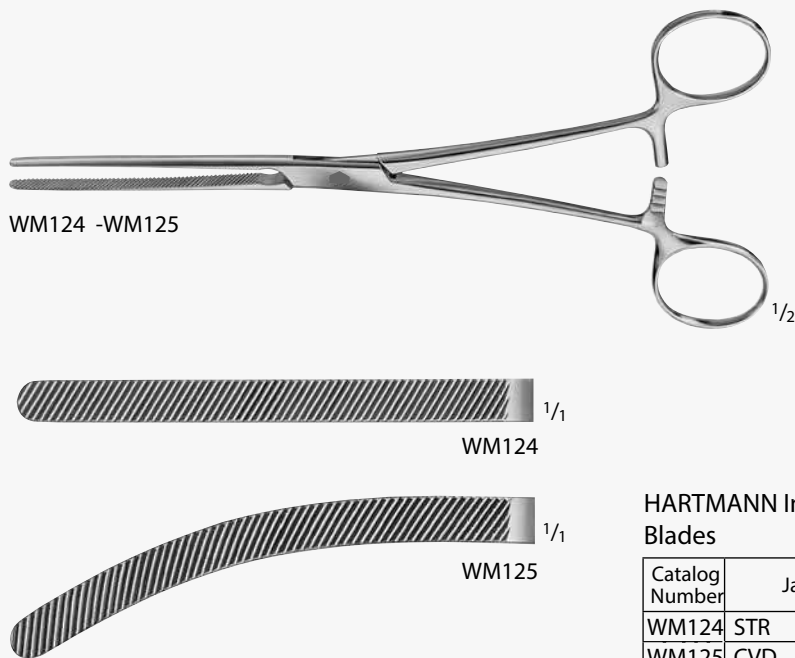

WM124 -WM125

HARTMANN Intestinal Clamp, Elastic Blades

Catalog Number	Jaw	Length (in.)
WM124	STR	7 7/8
WM125	CVD	7 7/8

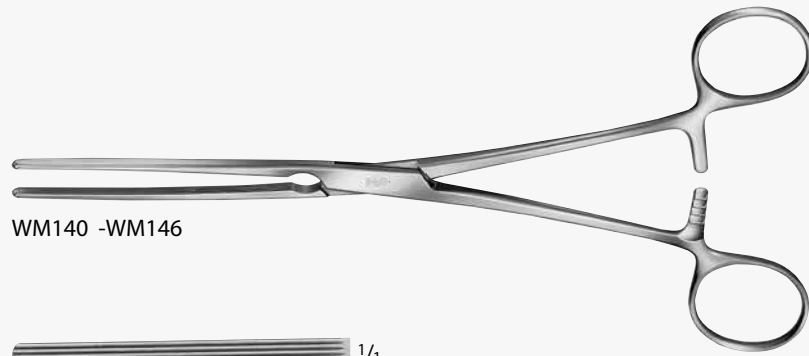

WM140 -WM146



WM116



WM140



WM145



WM117



WM141



WM146

KOCHER Intestinal Forceps,  
Elastic Blades

Catalog Number	Jaw	Length (in.)
WM116	STR	6 1/8
WM140	STR	8 1/4
WM145	STR	9
WM117	CVD	5 1/4
WM141	CVD	8 1/4
WM146	CVD	9



WM150 -WM156



WM150  $\frac{1}{16}$



WM151  $\frac{1}{16}$



WM152  $\frac{1}{16}$



WM155  $\frac{1}{16}$



WM156  $\frac{1}{16}$



KOCHER Intestinal Forceps, Elastic Blades

Catalog Number	Jaw	Length (in.)
WM150	STR	8 3/4
WM151	STR	9 3/4
WM152	STR	11
WM155	CVD	8 3/4
WM156	CVD	9 3/4

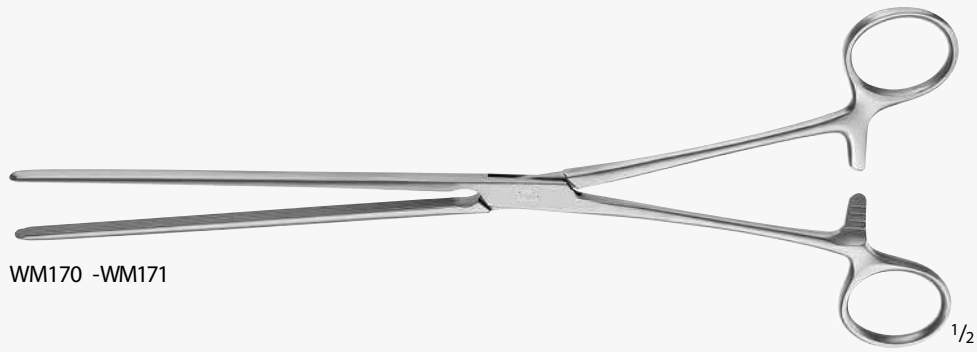

MAYO-ROBSON Intestinal Forceps,  
Hard Elastic Blades

Catalog Number	Jaw	Length (in.)
WM170	STR	9 3/4
WM171	CVD	9 3/4



WM305 -WM450

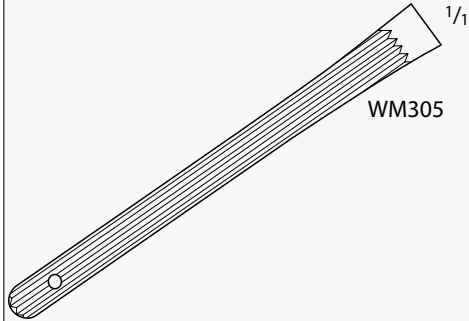

WM305

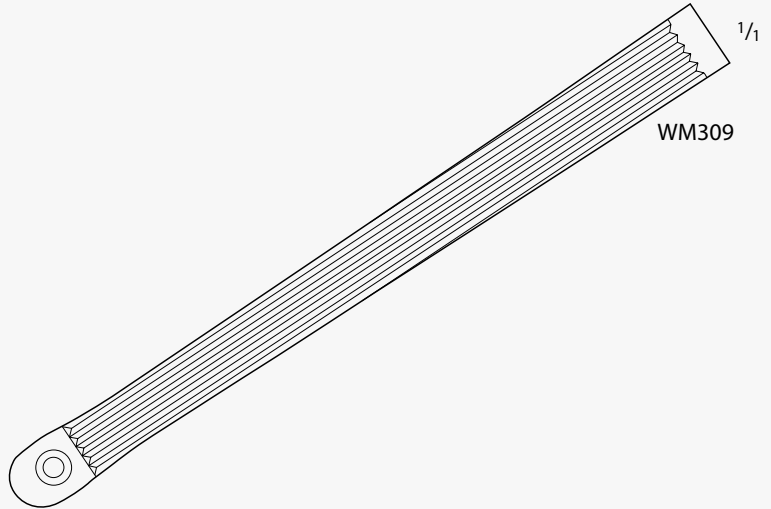

WM309

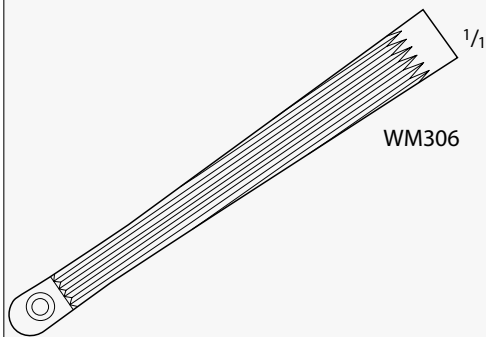

WM306



WM450



PAYR Intestinal Clamp

Catalog Number	Length (in.)
WM305	7
WM306	7 7/8
WM309	10 3/4
WM450	12 1/2



WM331 -WM332

DEMARTEL-WOLFSON Anastomosis Clamp

Catalog Number	Description	Length (in.)
WM331	SET OF 3	4
WM332	SET OF 3	4 3/4



WM334



WM334

Clamp Holder for Anastomosis Clamp

Catalog Number	Description	Length (in.)
WM334	3" FOR USE WITH LQ331C -LQ332C	3 1/8

INCHES

1  
2  
3  
4  
5  
6  
7  
8  
9  
10  
11

INCHES



WM397



WM397

KLEINSCHMIDT Appendectomy Forceps

Catalog Number	Jaw	Length (in.)
WM397	CVD	5 1/8

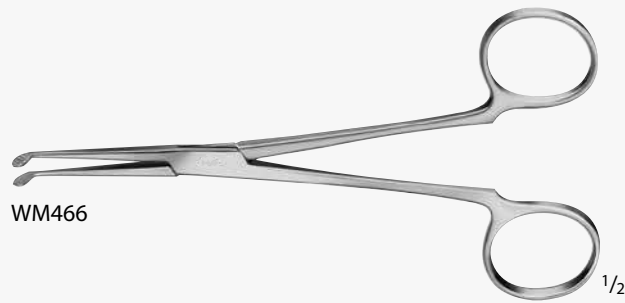

WM466



WM466

BENSON Pylorus Spreader

Catalog Number	Length (in.)
WM466	6 1/8

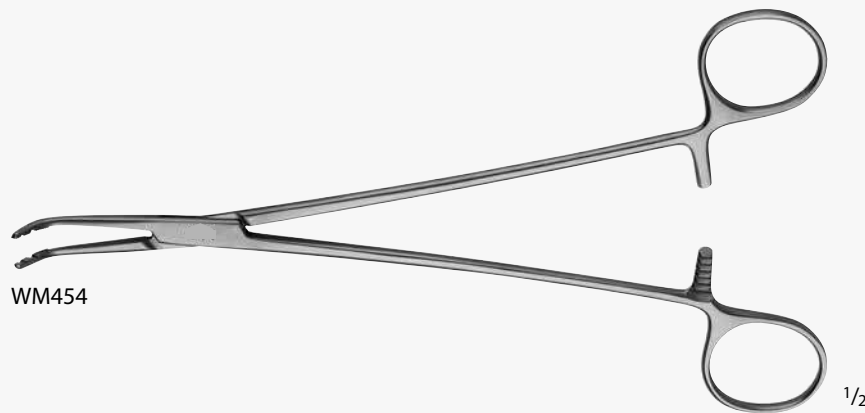

WM454



WM454

TAUFIC Cholangiography Clamp

Catalog Number	Length (in.)
WM454	8 1/2

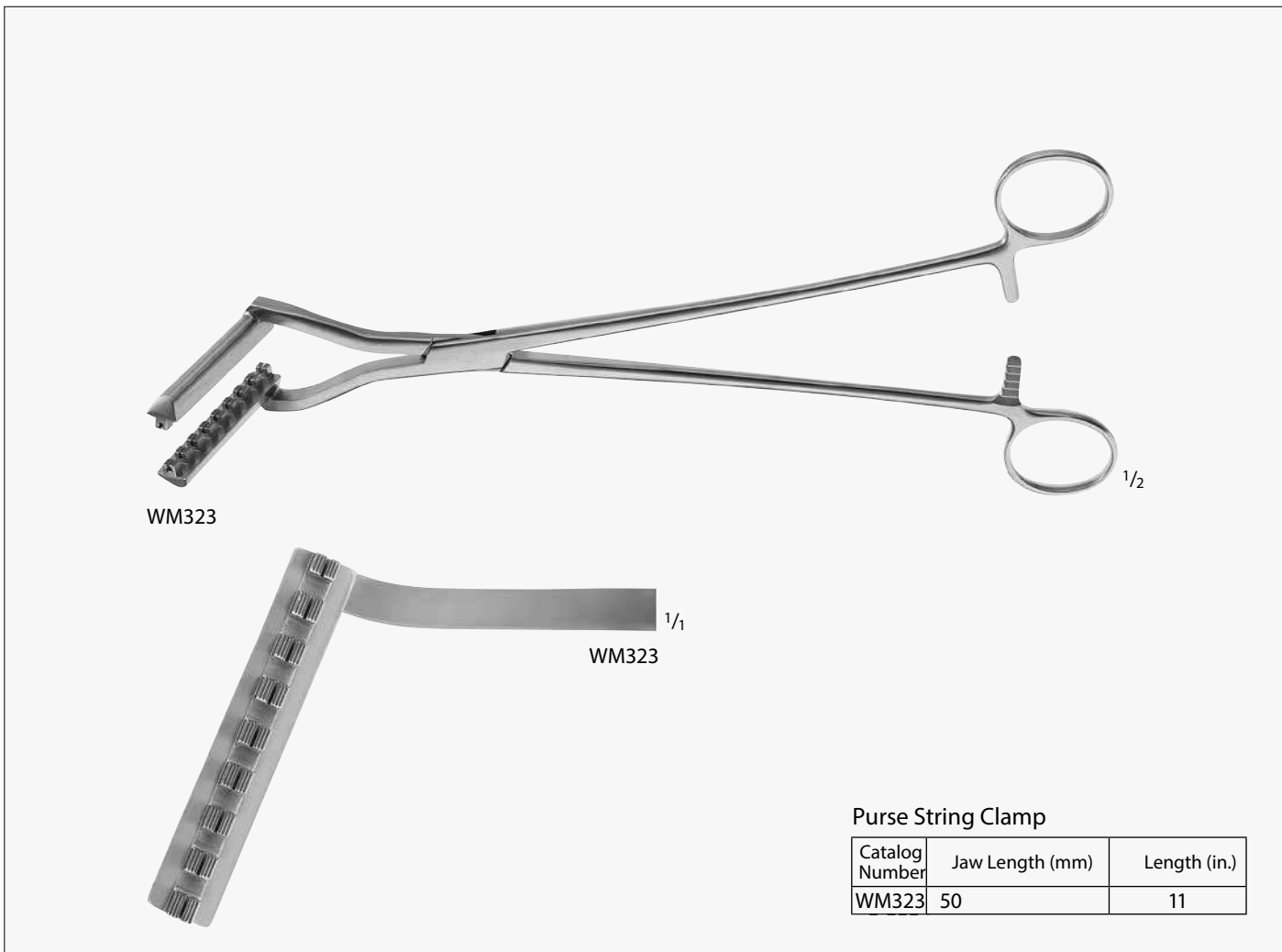
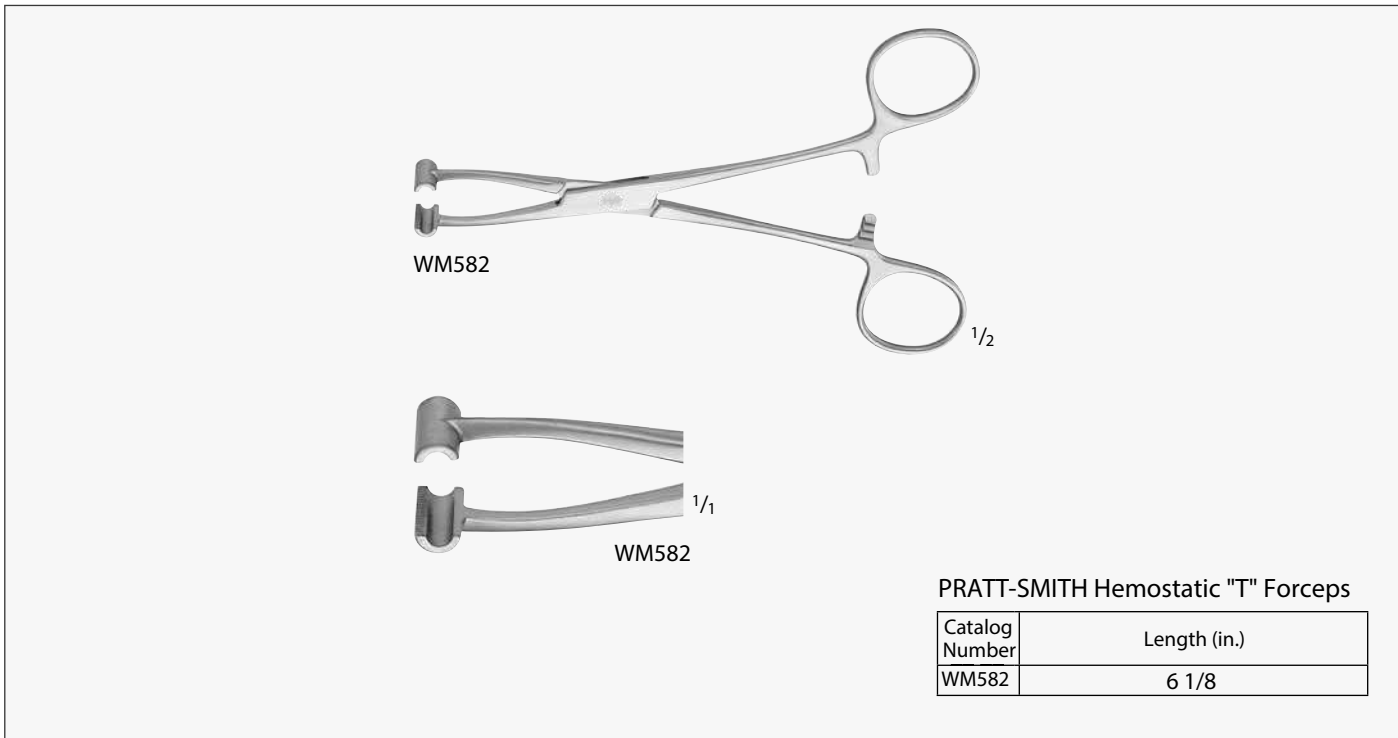

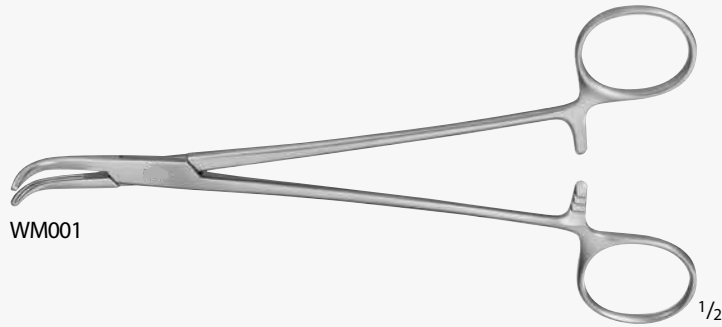

LOWER Gall Duct Forceps

Catalog Number	Jaw	Length (in.)
WM001	HEAVY-CVD	7

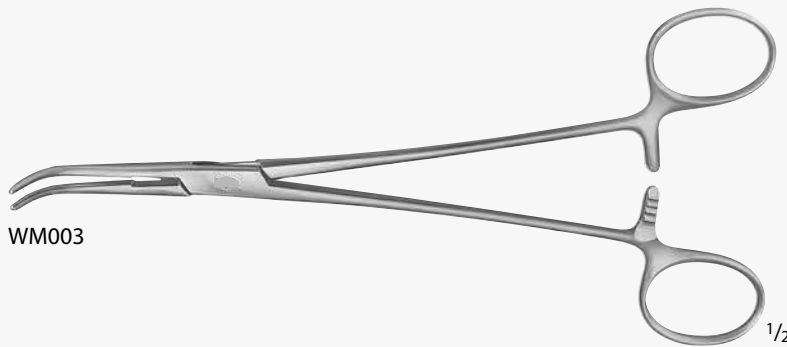

LAHEY (SWEET) Gall Duct Forceps

Catalog Number	Jaw	Length (in.)
WM003	CVD	7 7/8

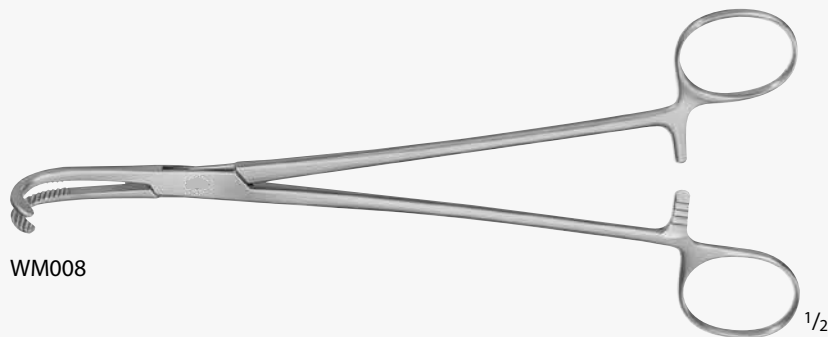

DESJARDINS Gall Duct Forceps

Catalog Number	Jaw	Length (in.)
WM008	HEAVY-CVD	8 3/4

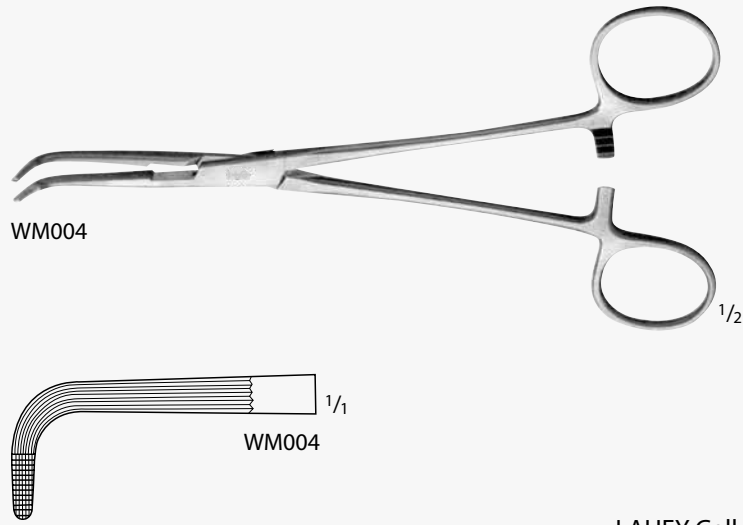

LAHEY Gall Duct Forceps

Catalog Number	Jaw	Length (in.)
WM004	HEAVY-CVD	7 1/2

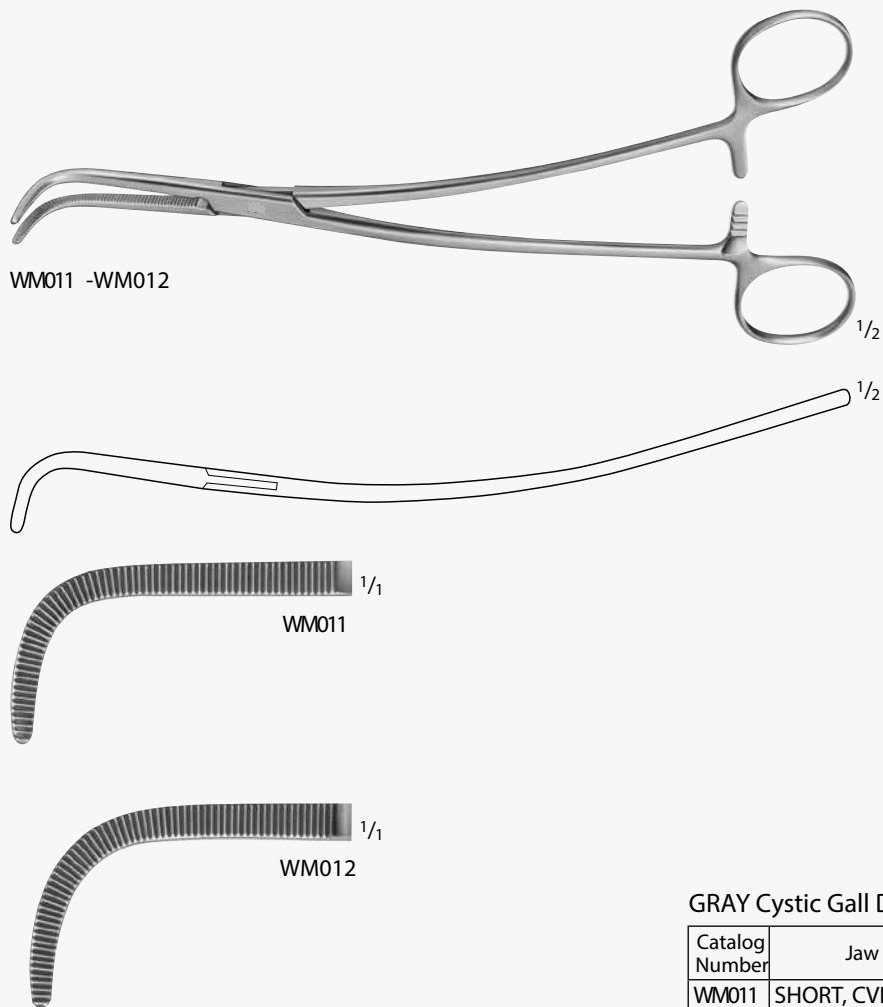

GRAY Cystic Gall Duct Forceps

Catalog Number	Jaw	Length (in.)
WM011	SHORT, CVD	8 3/4
WM012	LONG, CVD	8 3/4

INCHES



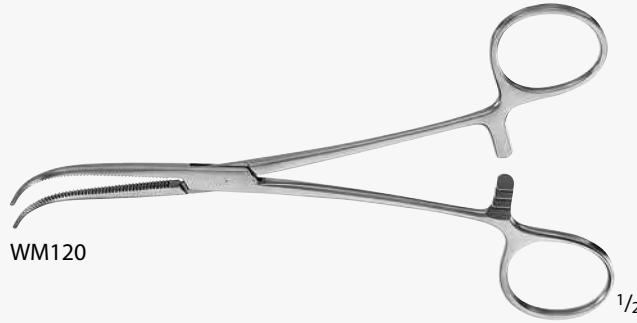

WM120



WM120

MIXTER Gall Duct Forceps

Catalog Number	Jaw	Length (in.)
WM120	HEAVY-CVD	6 1/4

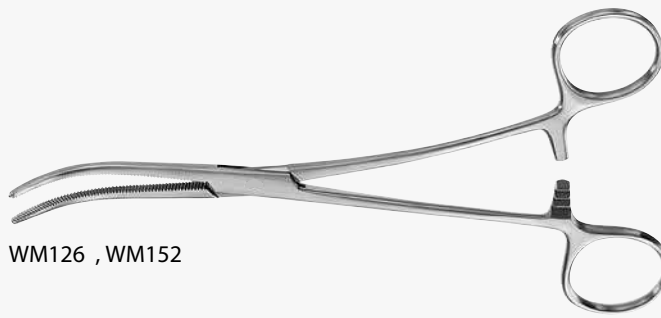

WM126 , WM152



WM126

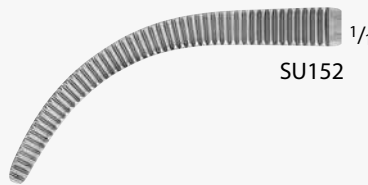

SU152

SHALLCROSS Cystic Duct Forceps

Catalog Number	Jaw	Length (in.)
WM126	CVD	6 7/8
WM152	FULL-CVD	8



WM220 - WM221



WM220

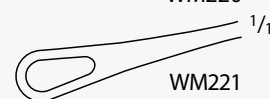

WM221

BLAKE Gall Stone Forceps

Catalog Number	Jaw	Length (in.)
WM220	STR	8
WM221	CVD	8



WM231 -WM234

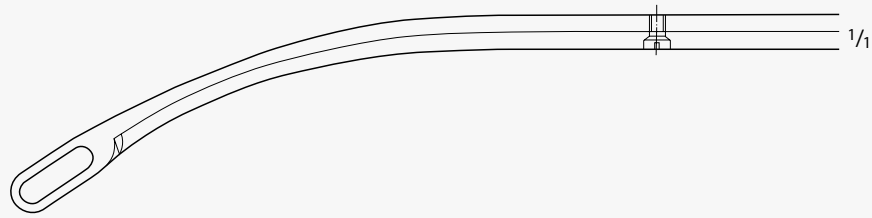

WM231



WM232



WM233



WM234



DESJARDINS Gall Stone Forceps

Catalog Number	Tip	Length (in.)
WM231	OVAL	8 7/8
WM232	OVAL	8 7/8
WM233	TAPERED	8 7/8
WM234	TAPERED	8 7/8

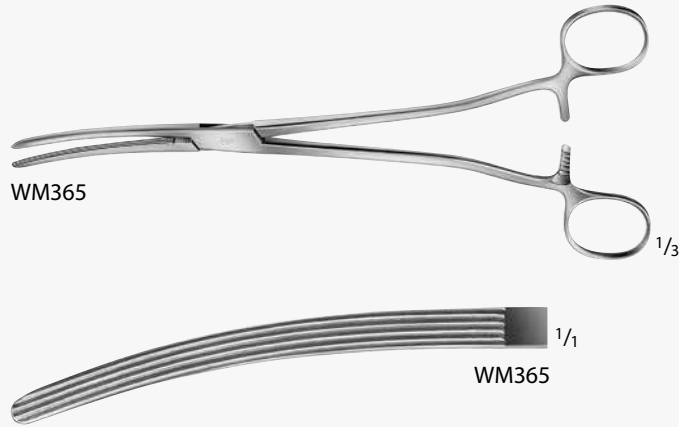

PARKER-KERR Forceps

Catalog Number	Jaw	Length (in.)
WM365	SLIGHT-CVD	9 3/4

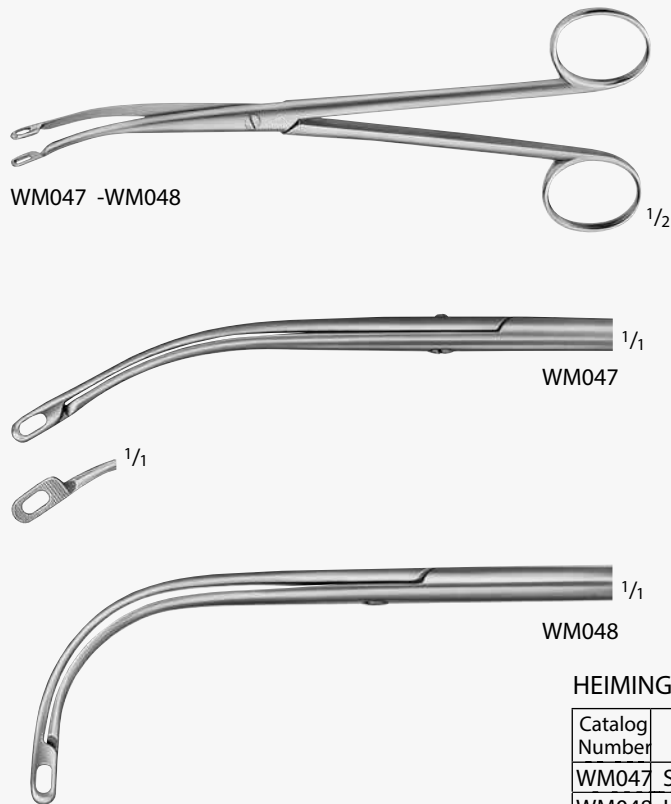

HEIMING Kidney Stone Forceps

Catalog Number	Jaw	Length (in.)
WM047	SLIGHT-CVD	6 3/4
WM048	HEAVY-CVD	6 1/4

INCHES

1  
2  
3  
4  
5  
6  
7  
8  
9  
10  
11

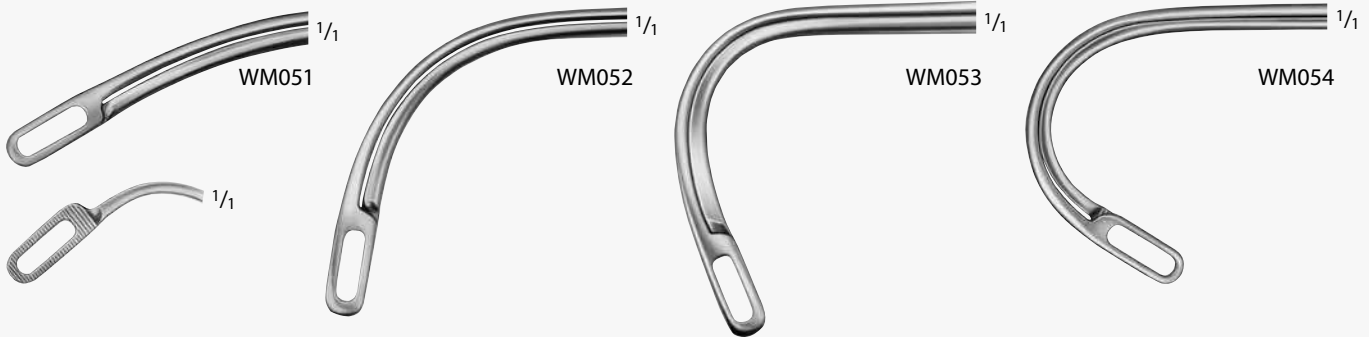

RANDALL Kidney Stone Forceps

Catalog Number	Jaw	Length (in.)
WM051	SLIGHT-CVD	8 7/8
WM052	HEAVY-CVD	8 7/8
WM053	CVD	8 7/8
WM054	U-CVD	8 7/8



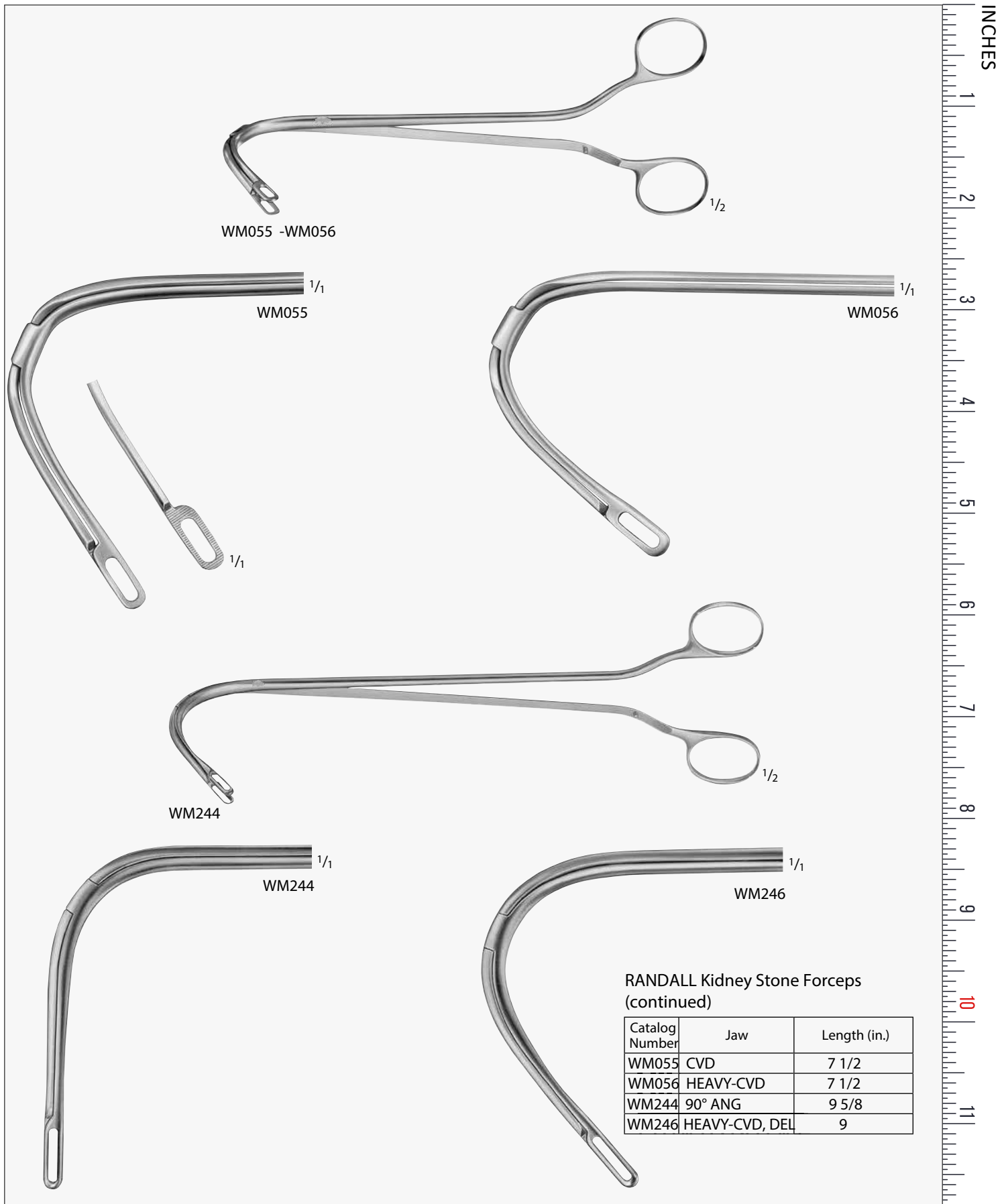

RANDALL Kidney Stone Forceps  
(continued)

Catalog Number	Jaw	Length (in.)
WM055	CVD	7 1/2
WM056	HEAVY-CVD	7 1/2
WM244	90° ANG	9 5/8
WM246	HEAVY-CVD, DEL	9

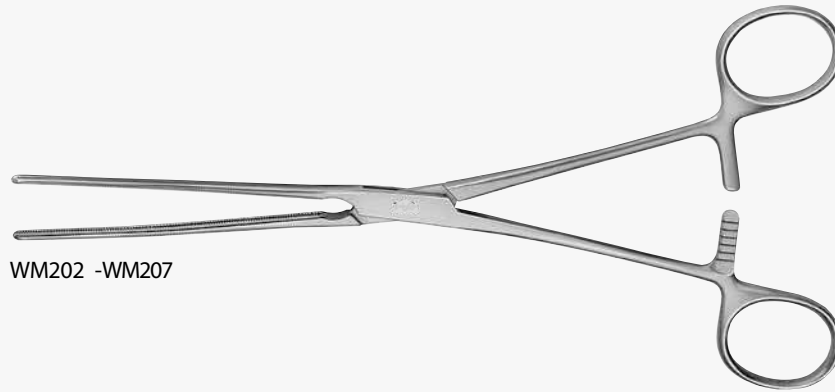

WM202 -WM207

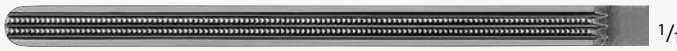

WM202



WM204



WM206



WM203



WM205



WM207



**KOCHER Atraumatic Forceps,  
Elastic Blades**

Catalog Number	Jaw	Length (in.)
WM202	STR	8 3/4
WM204	STR	9 3/4
WM206	STR	11
WM203	CVD	8 3/4
WM205	CVD	9 3/4
WM207	CVD	11

WM210 -WM211

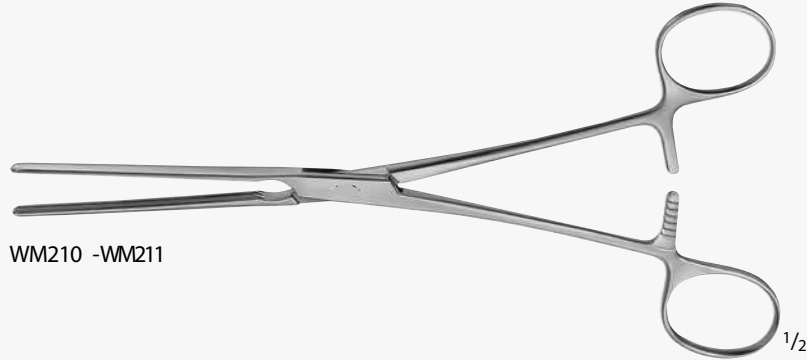

1/2



WM210

1/1

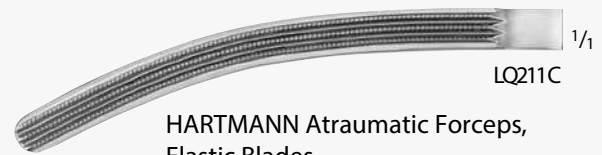

LQ211C

1/1

HARTMANN Atraumatic Forceps,  
Elastic Blades

Catalog Number	Jaw	Length (in.)
WM210	STR	7 7/8
WM211	CVD	7 7/8

WM216 -WM217

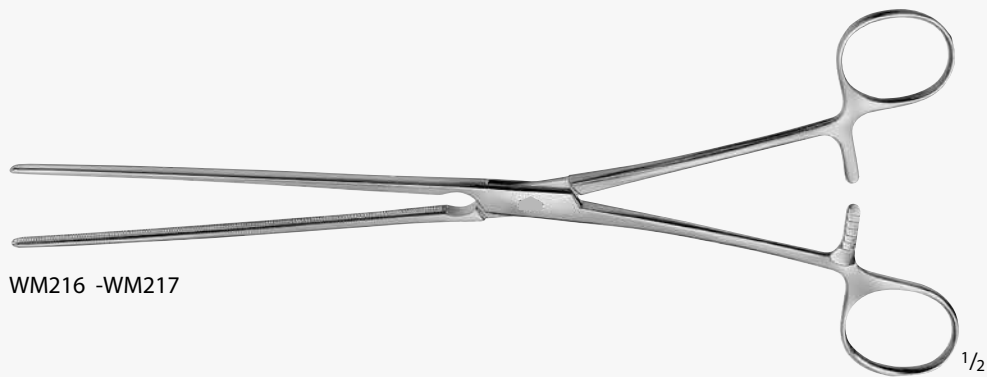

1/2



WM216

1/1



WM217

1/1

MAYO-ROBSON Atraumatic Forceps

Catalog Number	Jaw	Length (in.)
WM216	STR	9 3/4
WM217	CVD	9 3/4

INCHES



WWW.WYZZMEDICAL.COM

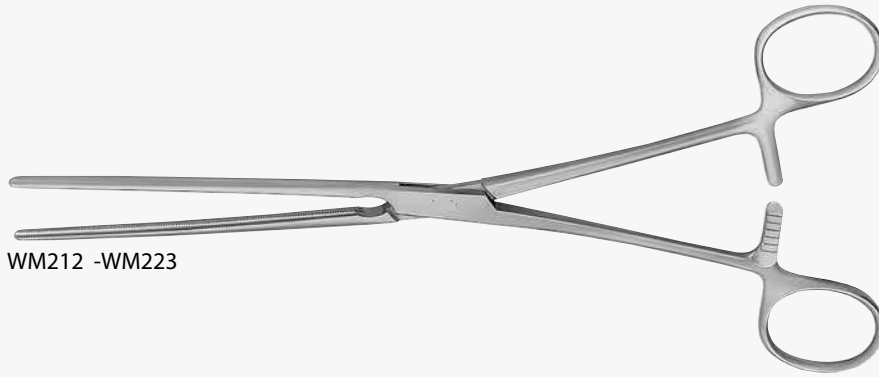

WM212 -WM223

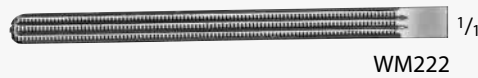

WM222



WM212



WM223



WM213

DOYEN Atraumatic Forceps,  
Elastic Blades

Catalog Number	Jaw	Length (in.)
WM222	STR	6 3/4
WM212	STR	9
WM223	CVD	6 3/4
WM213	CVD	9

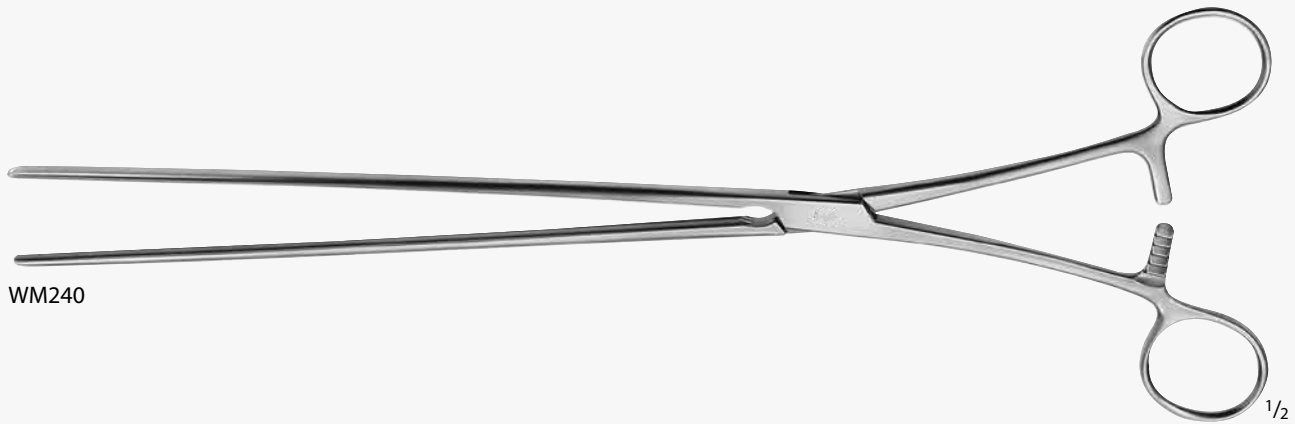

WM240



WM240

SCUDDER Atraumatic Forceps

Catalog Number	Jaw	Length (in.)
WM240	STR	13

INCHES





WM130 -WM932



WM931



WM130

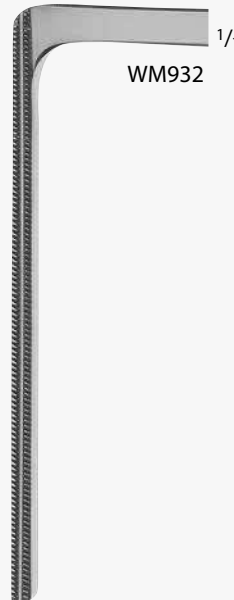

WM932

GLASSMAN Anterior Resection Clamp

Catalog Number	Jaw	Jaw Length (mm)	Length (in.)
WM931	90°, SERR	25	9 3/4
WM130	90°, SERR	50	9 3/4
WM932	90°, SERR	75	10

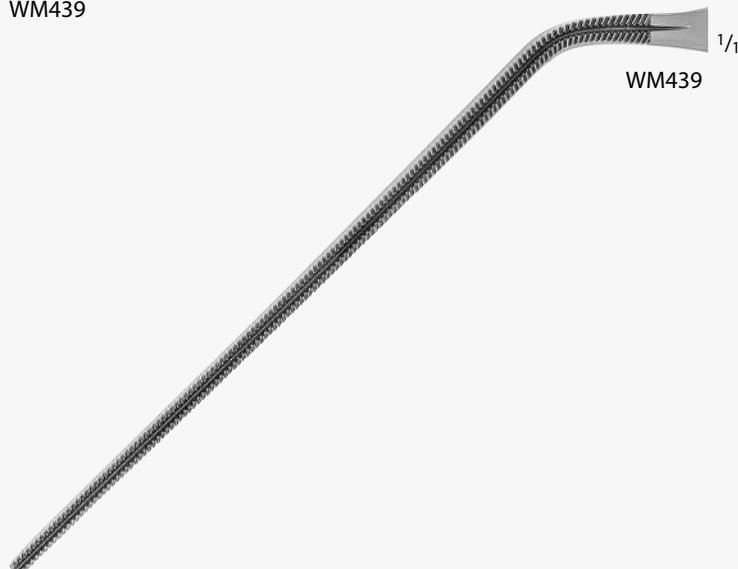
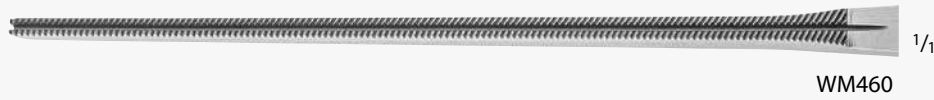

CARTER-GLASSMAN Resection Clamp

Catalog Number	Jaw	Jaw Length mm	Length in.
WM460	STR	110	11
WM439	45° ANG	103	10 1/4



WM436 -WM438



WM436



WM437



WM438



GLASSMAN Intestinal and Liver Holding Clamp, Non-Crushing

Catalog Number	Jaw	Length (in.)
WM436	STR	9 3/4
WM437	CVD	9 5/8
WM438	FULL CVD	9



WM433 -WM434



WM433



WM434

GLASSMAN Gastroenterostomy Clamp

Catalog Number	Jaw	Jaw Length (mm)	Length (in.)
WM433	STR	116	11 1/2
WM434	ANG	115	11 1/2

INCHES

WM138WM -WM139



GLASSMAN Gastrointestinal Clamp, Non-Crushing

Catalog Number	Jaw	Length (in.)
WM138	STR	9 1/4
WM139	ANG	9

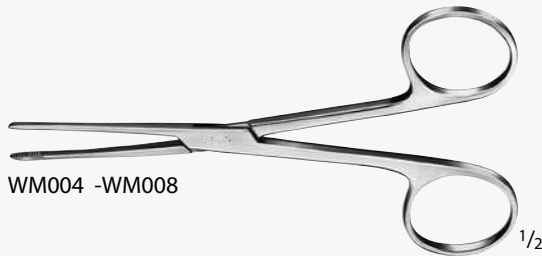
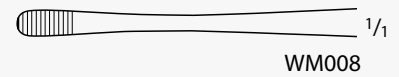
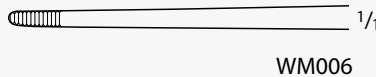
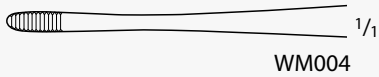

LISTER Sponge Forceps

Catalog Number	Jaw	Length (in.)
WM004	STR	5 1/4
WM006	STR	6 1/4
WM008	STR	7 1/4

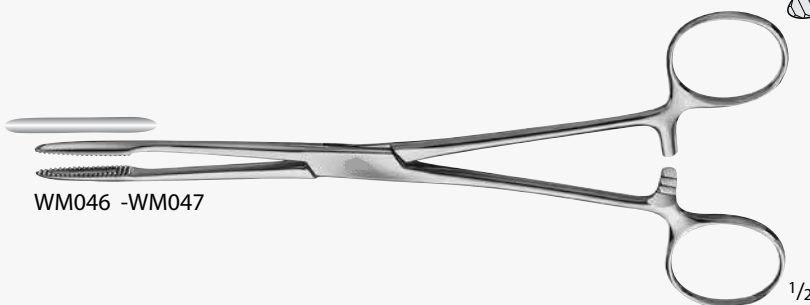
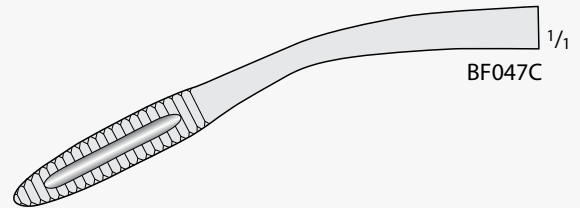

GROSS Forceps, W/ Ratchet

Catalog Number	Jaw	Length (in.)
WM046	STR	7 7/8
WM047	CVD	7 7/8



WM078

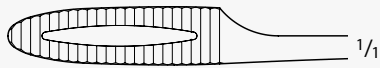

WM078

<sup>1/3</sup>  
SIMS-MAIER Sponge Forceps

Catalog Number	Jaw	Length (in.)
WM078	STR	13 3/4



WM062 -WM063



WM062



WM063

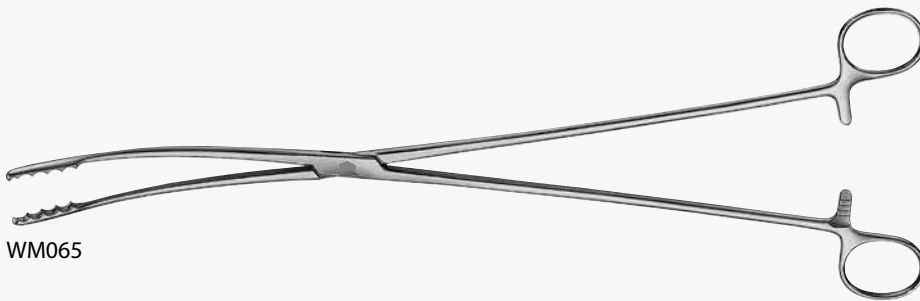

WM065



BF065C

ULRICH-AESFULAP Sponge Forceps

Catalog Number	Jaw	Length (in.)
WM062	STR	10 1/2
WM063	CVD	10 1/2
WM065	CVD	13 3/4

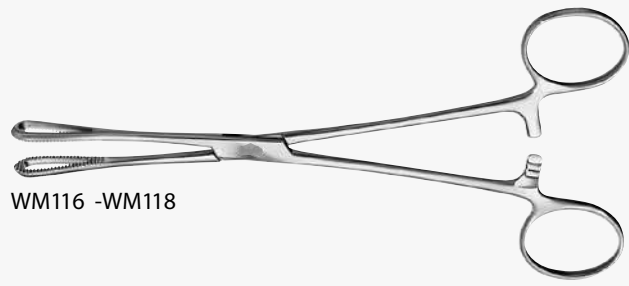

WM116 -WM118



WM116

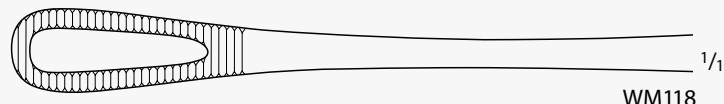

WM118



RAMPLEY Sponge Forceps

Catalog Number	Tip	Jaw	Length (in.)
WM116	SERR	STR	7
WM118	SERR	STR	9 3/4



WM098 -WM904



WM098



WM099



WM904

FOERSTER Sponge Forceps

Catalog Number	Tip	Jaw	Length (in.)
WM098	SERR	STR	12
WM099	SERR	STR	14
WM904	SERR	STR	16

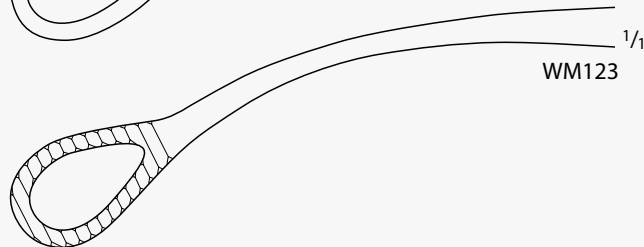
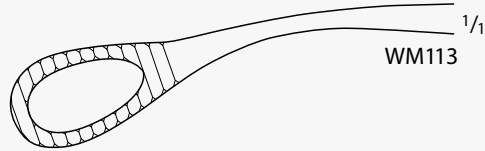
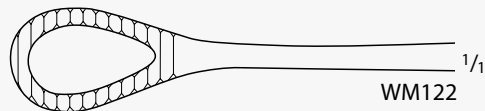
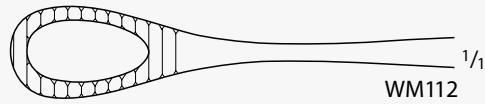
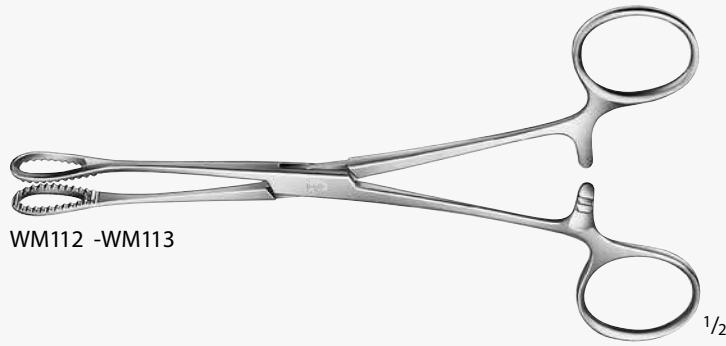

FOERSTER-BALLENGER Sponge Forceps

Catalog Number	Tip	Jaw	Length (in.)
WM112	SERR	STR	7
WM120	SMOOTH	STR	9 5/8
WM122	SERR	STR	9 5/8
WM113	SERR	CVD	7
WM121	SMOOTH	CVD	9 5/8
WM123	SERR	CVD	9 5/8

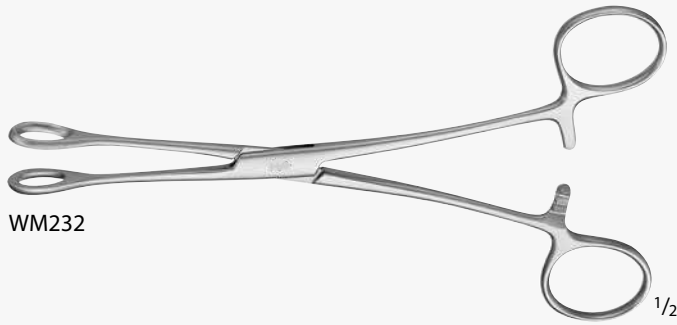

WM232



DP232

**BALENGER Sponge Forceps**

Catalog Number	Tip	Jaw	Length (in.)
WM232	SMOOTH	STR	7

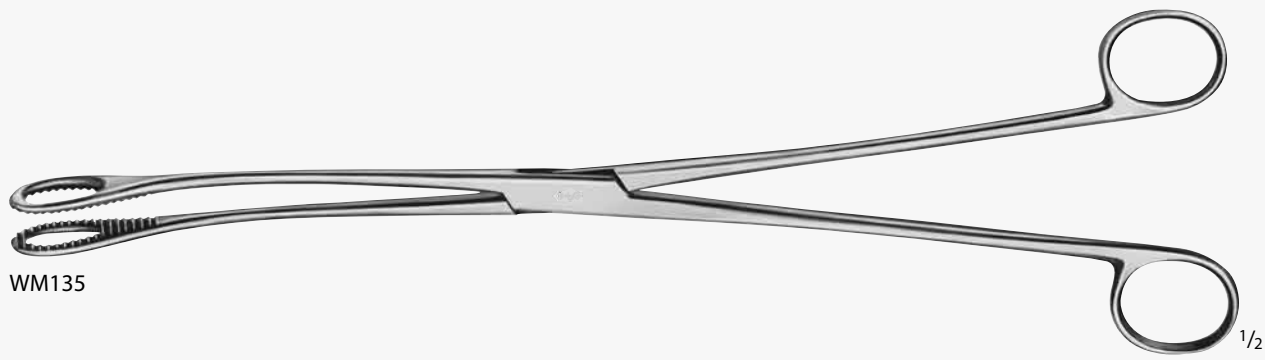

WM135

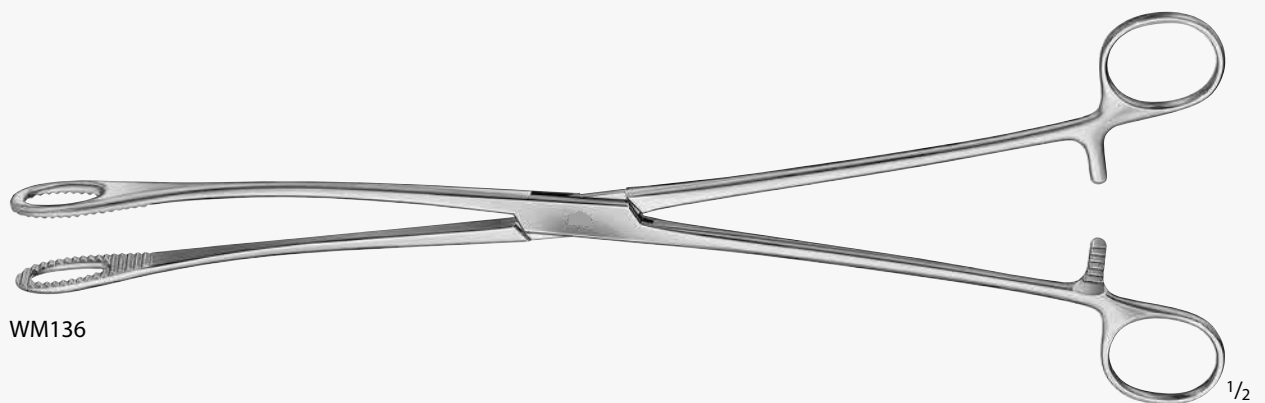

WM136



WM135 - WM136

**KELLY Sponge Forceps**

Catalog Number	Tip	Jaw	Handle	Length (in.)
WM135	SERR	CVD	W/ OUT RATCHET	12 1/2
WM136	SERR	CVD	W/ RATCHET	12 1/2

INCHES





WM379 -WM381

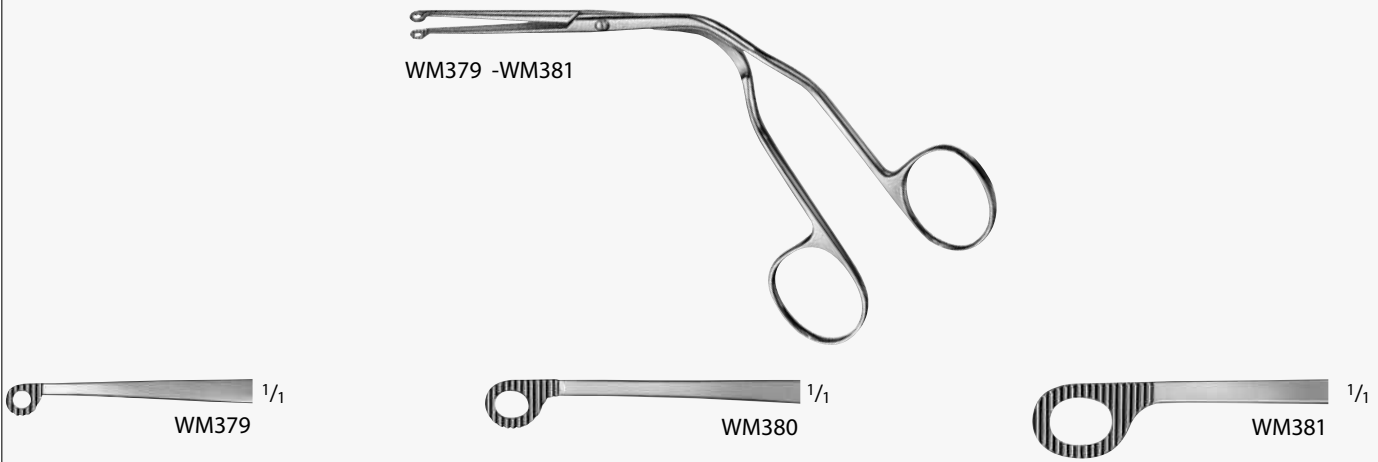

MAGILL Forceps

Catalog Number	Size	Length (in.)
WM379	INFANT	6
WM380	PEDIATRIC	7 7/8
WM381	ADULT	9 3/4

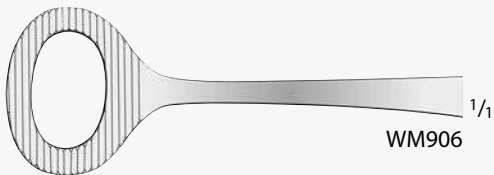

WM906

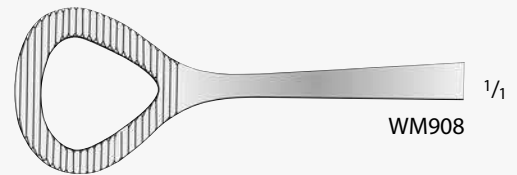

WM908

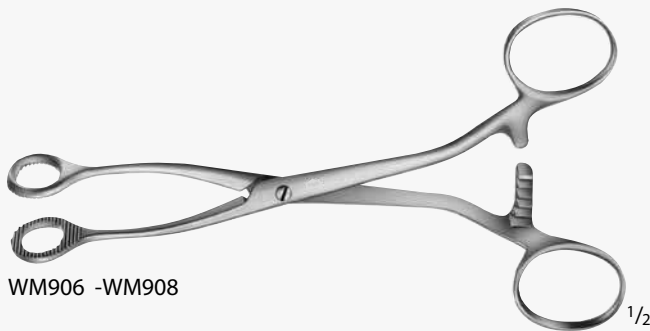

WM906 -WM908

COLLIN Forceps W/ Ratchet

Catalog Number	Jaw	Length (in.)
WM906	OVAL	6 1/4
WM908	TEARDROP	6 1/4

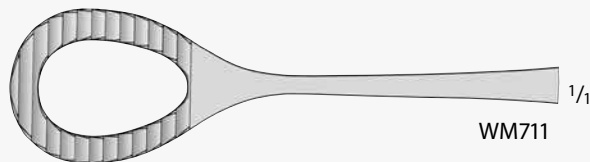
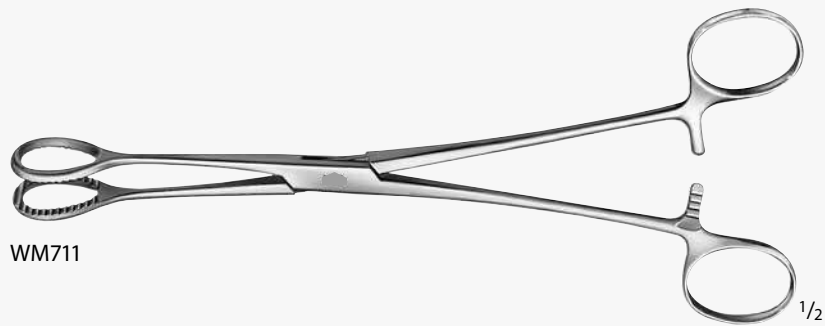
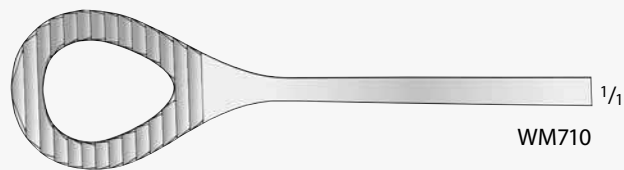
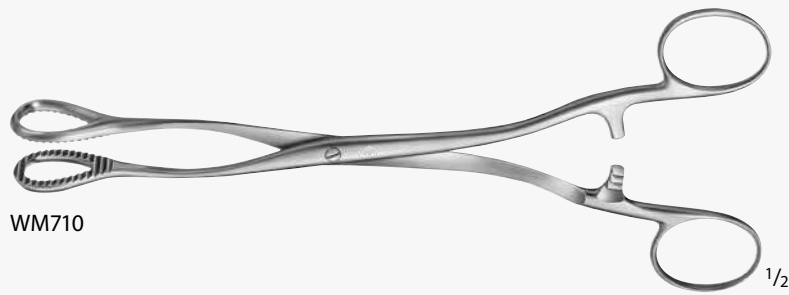

HEYWOOD-SMITH Forceps

Catalog Number	Tip	Length (in.)
WM710	SERR	7 7/8
WM711	SERR	8 1/4

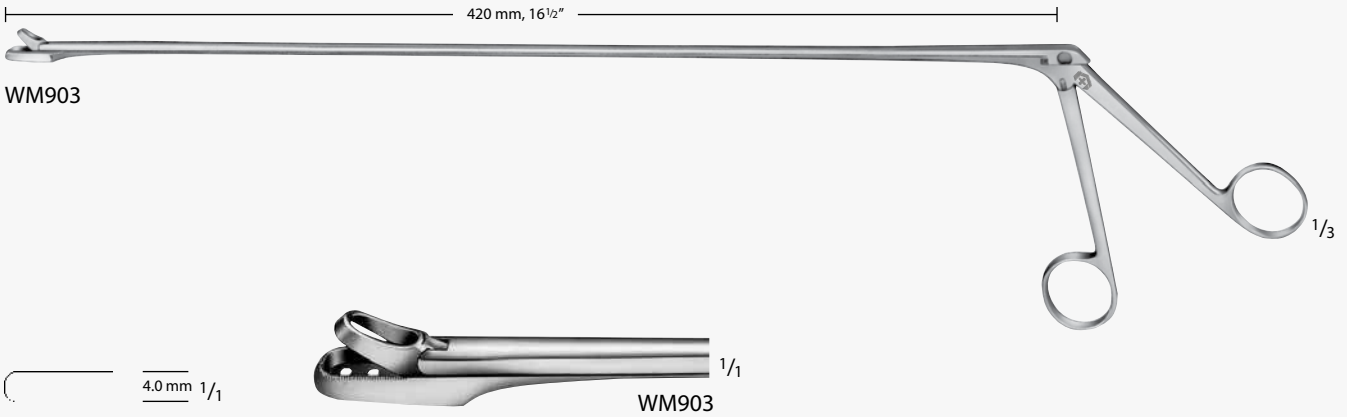

YEOMAN Rectal Biopsy Forceps

Catalog Number	Tip Size (mm)	Shaft Length (in.)
WM903	4	16 1/2

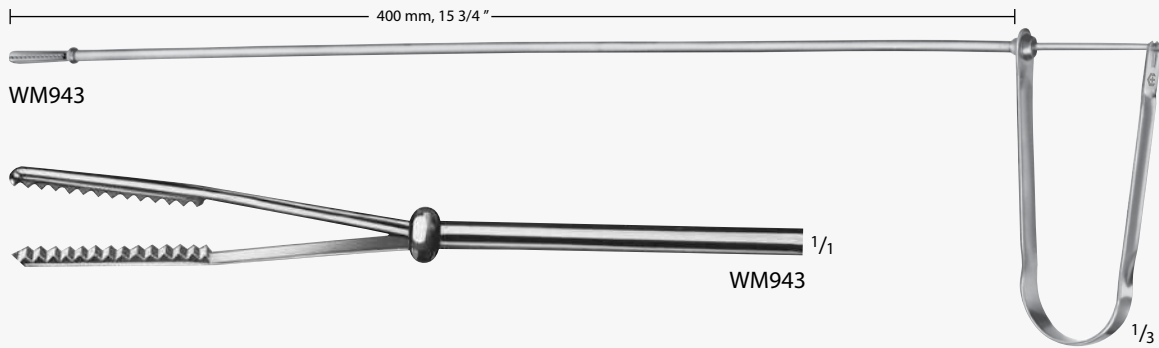

AESCULAP Rectal Swab Holder

Catalog Number	Shaft Length (in.)
WM943	15 3/4



WM200



WM098

PRICE Muscle Biopsy Clamp

Catalog Number	Jaw	Jaw Size (mm)	Length (in.)
WM200	DOUBLE-PRONG	8	4
WM098	DOUBLE-PRONG	15	4 3/8



WM332 -WM339



WM332



WM333



WM334



WM335



WM336



WM337



WM338



WM339

SPENCER-WELLS Forceps

Catalog Number	Jaw	Length (in.)
WM332	STR	5 1/8
WM334	STR	6
WM336	STR	6 7/8
WM338	STR	7 7/8
WM333	CVD	5 1/8
WM335	CVD	6
WM337	CVD	6 7/8
WM339	CVD	7 7/8



WM412 -WM415



WM412



WM413



WM414C



WM415

PEAN Forceps, Delicate

Catalog Number	Jaw	Length (in.)
WM412	STR	5 1/8
WM414	STR	5 1/2
WM413	CVD	5 1/8
WM415	CVD	5 1/2

INCHES





WM410

1/2



WM410

1/1

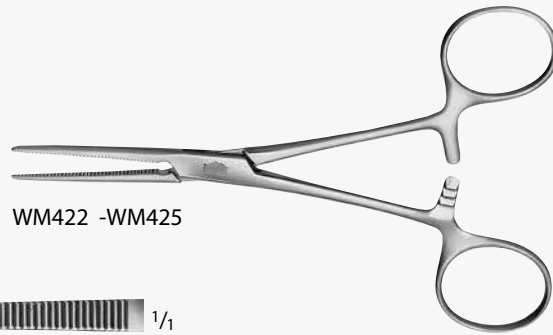

WM422 -WM425



WM422

1/1



WM424

1/1



WM425

1/1

PEAN Forceps

Catalog Number	Jaw	Length (in.)
WM410	STR	5
WM422	STR	5 1/8
WM424	STR	5 1/2
WM425	CVD	5 1/2



WM180 -WM181

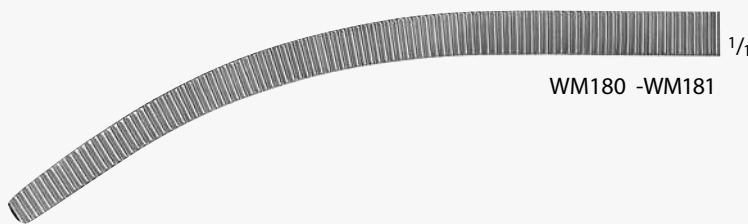

WM180 -WM181

1/1

PEAN Artery Forceps

Catalog Number	Jaw	Length (in.)
WM180	CVD	12
WM181	CVD	14



WM442 -WM451



WM442



WM444



WM446



WM448



WM450



WM443



WM445



WM447



WM449

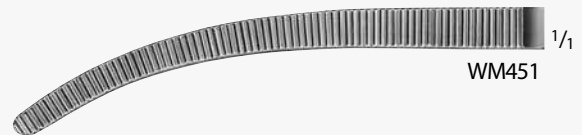

WM451



ROCHESTER-PEAN Forceps

Catalog Number	Jaw	Length (in.)
WM442	STR	6 1/4
WM444	STR	7 1/4
WM446	STR	7 7/8
WM448	STR	8 7/8
WM450	STR	9 1/2
WM443	CVD	6 1/4
WM445	CVD	7 1/4
WM447	CVD	7 7/8
WM449	CVD	8 7/8
WM451	CVD	9 1/2



WM470 -WM475 , WM128



WM470



WM472



WM474



DP128C



WM471



WM473

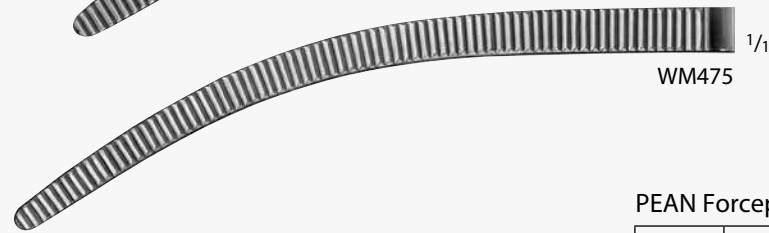

WM475

PEAN Forceps, Long

Catalog Number	Jaw	Length (in.)
WM470	STR	9 1/2
WM472	STR	10 1/4
WM474	STR	11
WM128	STR	12
WM471	CVD	9 1/2
WM473	CVD	10 1/4
WM475	CVD	11





WM614 -WM615



WM614



MO615C

KOCHER Forceps, Delicate

Catalog Number	Jaw	Teeth	Length (in.)
WM614	STR	1 x 2	5 1/2
WM615	CVD	1 x 2	5 1/2

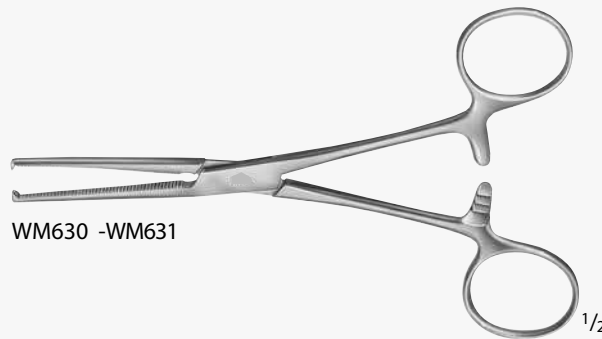

WM630 -WM631



WM630



WM631

KOCHER Forceps

Catalog Number	Jaw	Teeth	Length (in.)
WM630	STR	1 x 2	6
WM631	CVD	1 x 2	6

INCHES

1

2

3

4

5

6

7

8

9

10

11

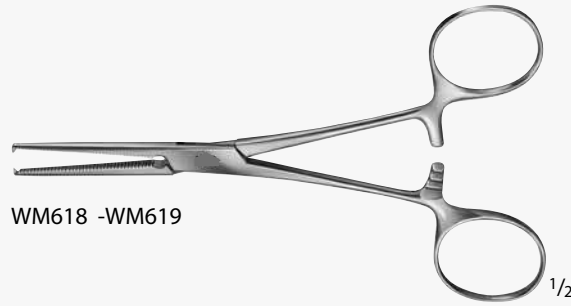

ROCHESTER-OCHSNER Forceps

Catalog Number	Jaw	Teeth	Length (in.)
WM618	STR	1 x 2	5 1/2
WM619	CVD	1 x 2	5 1/2

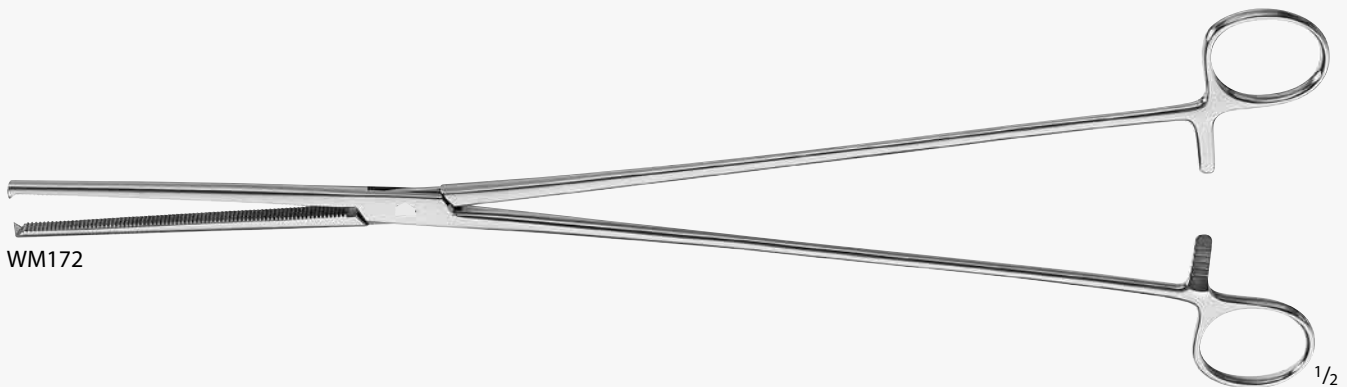

ROCHESTER-OCHSNER Artery Forceps

Catalog Number	Jaw	Teeth	Length (in.)
WM172	STR	1 x 2	14

INCHES

1  
2  
3  
4  
5  
6  
7  
8  
9  
10  
11



WM642 -WM655



WM642



WM644



WM646



WM648



WM650



WM652



WM654



WM643



WM645



WM647

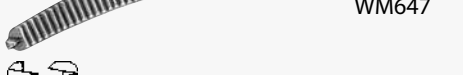

WM649



WM649



WM651



WM653



WM655

KOCHER-OCHSNER Forceps

Catalog Number	Jaw	Teeth	Length (in.)
WM642	ST	1 x 2	6 1/4
WM644	STR	1 x 2	7 1/4
WM646	STR	1 x 2	7 7/8
WM648	STR	1 x 2	8 7/8
WM650	STR	1 x 2	9 1/2
WM652	STR	1 x 2	10 1/4
WM654	STR	1 x 2	11
WM643	CVD	1 x 2	6 1/4
WM645	CVD	1 x 2	7 1/4
WM647	CVD	1 x 2	7 7/8
WM649	CVD	1 x 2	8 7/8
WM651	CVD	1 x 2	9 1/2
WM653	CVD	1 x 2	10 1/4
WM655	CVD	1 x 2	11

INCHES



WWW.WYZZMEDICAL.COM



WM807 , WM909



WM807

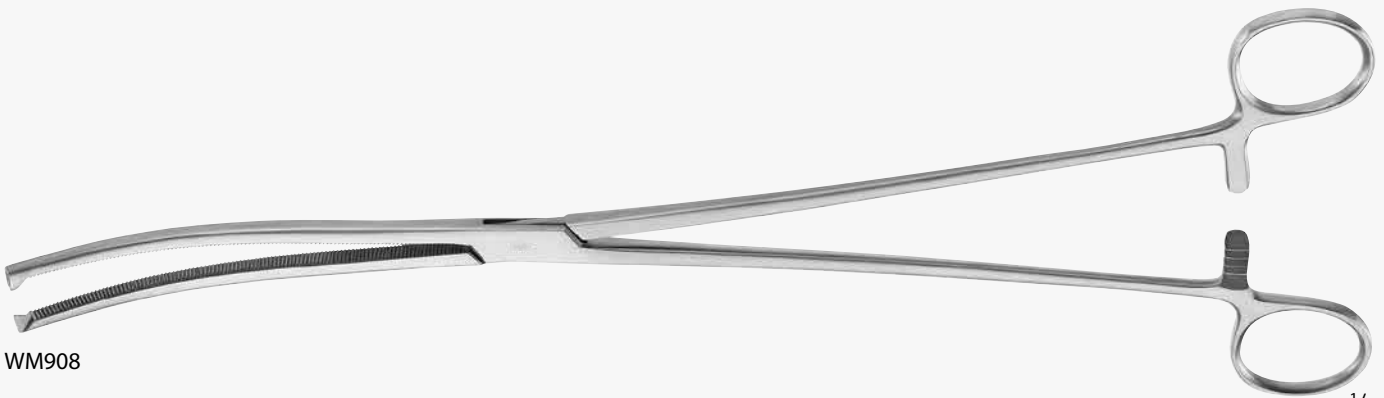

WM908



WM908



ROCHESTER-OCHSNER Forceps

Catalog Number	Jaw	Teeth	Length (in.)
WM807	STR	1 x 2	14
WM909	STR	1 x 2	16
WM908	CVD	1 x 2	13 3/4

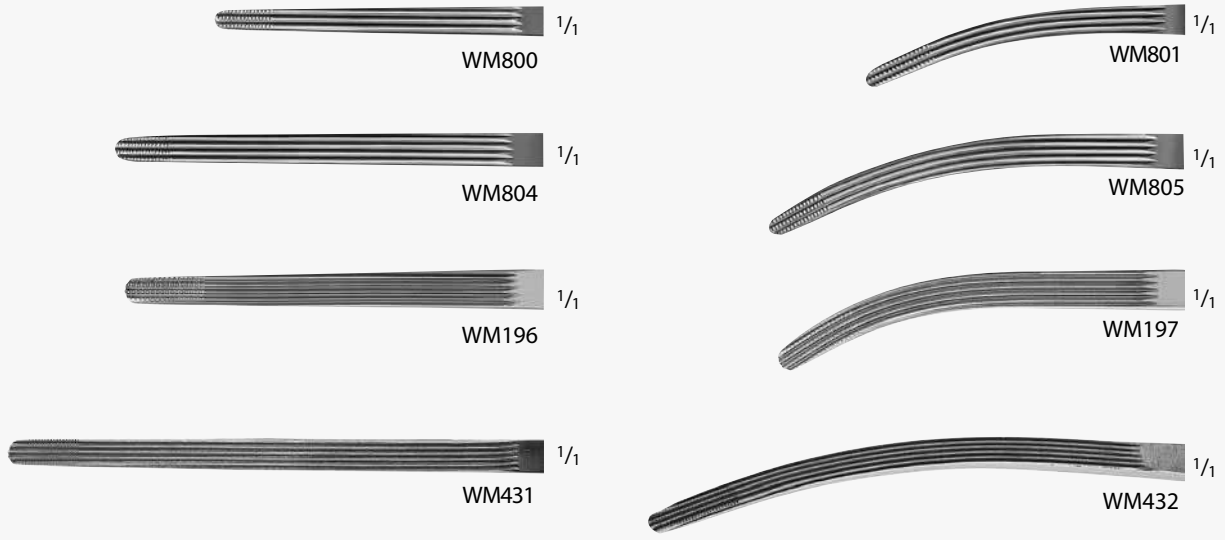

WM800C , WM432

**ROCHESTER-CARMALT Forceps**

Catalog Number	Jaw	Length (in.)
WM800	STR	6 1/4
WM804	STR	7 7/8
WM196	STR	9
WM431	STR	10 1/4
WM801	CVD	6 1/4
WM805	CVD	7 7/8
WM197	CVD	9
WM432	CVD	10 1/4

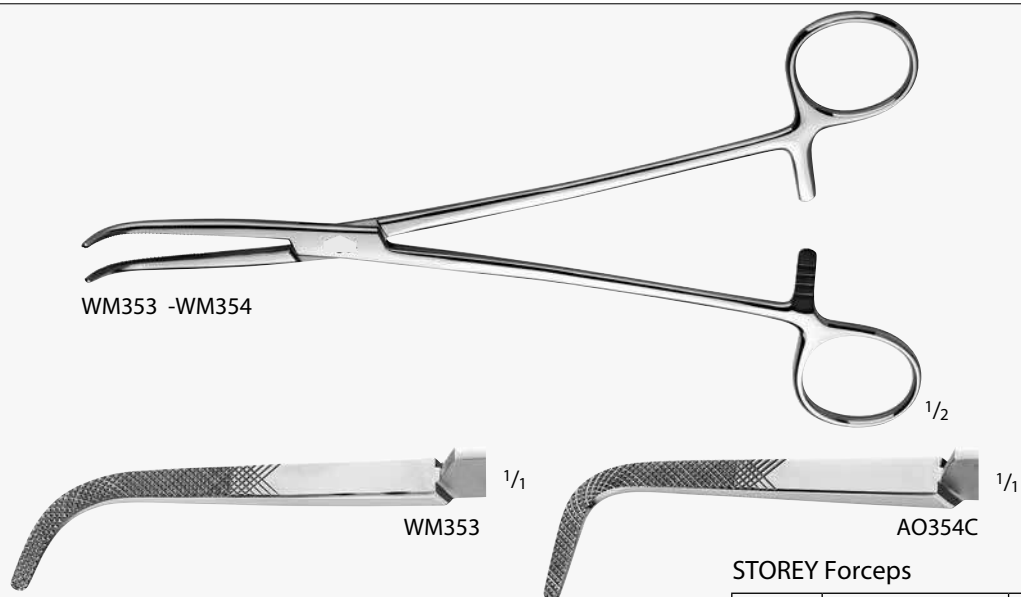

WM353 -WM354

**STOREY Forceps**

Catalog Number	Tip	Length (in.)
WM353	STRONG-CVD	8 3/4
WM354	RIGHT-ANG	8 3/4





WM426

1/2



WM426

JONES Hemostatic Forceps

Catalog Number	Jaw	Length (in.)
WM426	STR	5

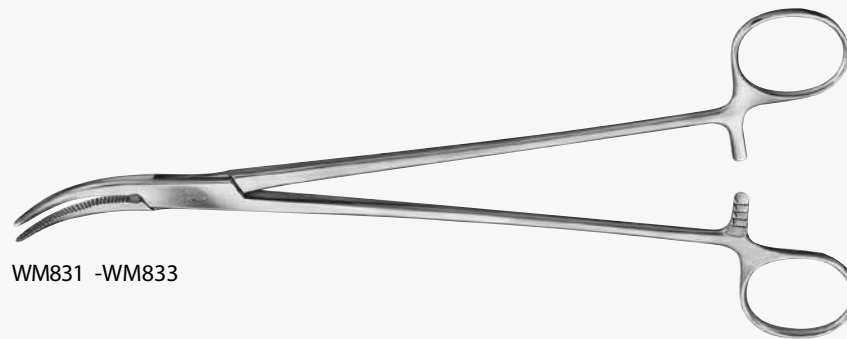

WM831 -WM833

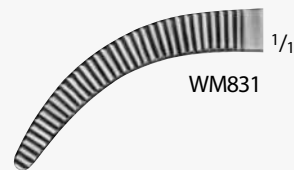

WM831

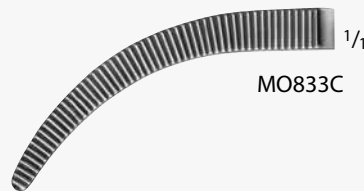

MO833C

MOYNIHAN Forceps

Catalog Number	Jaw	Length (in.)
WM831	CVD	9
WM833	CVD	9 1/2

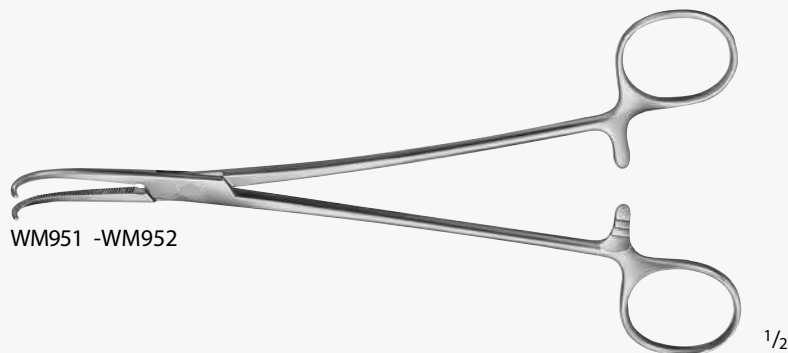

WM951 -WM952

1/2



WM951



WM952

NEGUS Tonsil Forceps

Catalog Number	Jaw	Length (in.)
WM951	HEAVY-CVD	7 1/2
WM952	U-CVD	7 1/2

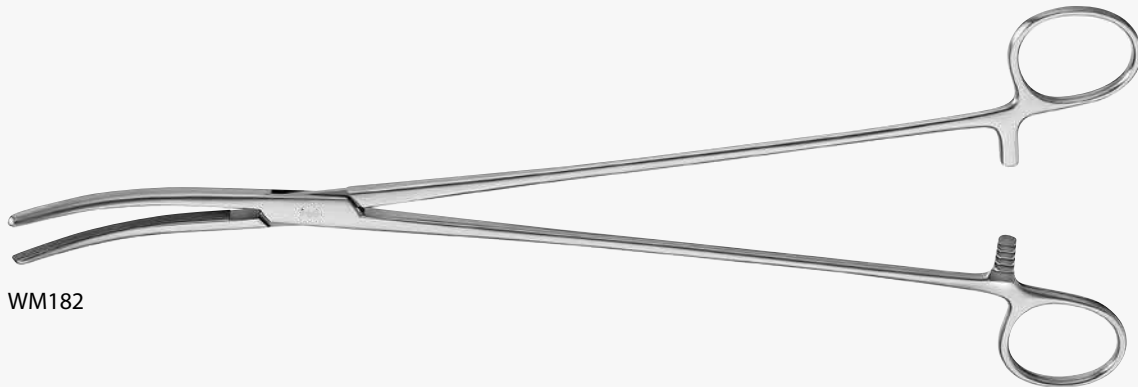

WM182

WM182

CARMALT Artery Forceps, Longitudinal Serrations

Catalog Number	Jaw	Length (in.)
WM182	SLIGHT-CVD	12



WM172 , WM961 , WM963



WM172



WM961



WM963

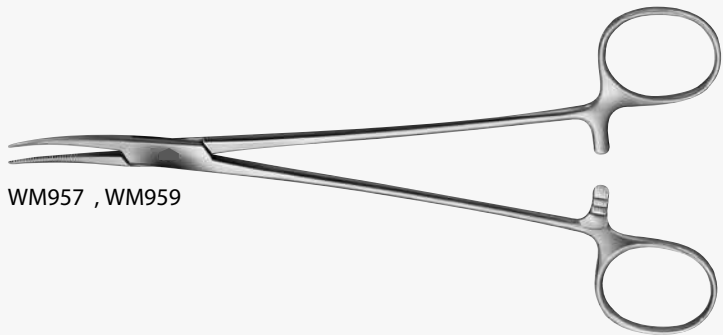

WM957 , WM959



MO957C



MO959C

SCHNIDT Tonsil Clamp

Catalog Number	Ring Handle	Jaw	Length (in.)
WM172	OPEN RING	STR	7 1/2
WM961	OPEN-RING	SLIGHT-CVD	7 1/4
WM963	OPEN-RING	CVD	7 1/4
WM957	CLOSED-RING	SLIGHT-CVD	7 1/4
WM959	CLOSED-RING	CVD	7 1/4



WM450

1/2



1/1

WM450

OCHSNER-DIXON Artery Forceps

Catalog Number	Jaw	Teeth	Length (in.)
WM450	STR	1 x 2	6 1/4



WM104 -WM115

1/2



1/1

WM104



1/1

WM105



1/1

WM114



1/1

WM115

Baby HARTMANN Mosquito Artery Forceps

Catalog Number	Jaw	Teeth	Length (in.)
WM104	STR	-	4
WM114	STR	1 x 2	4
WM105	CVD	-	4
WM115	CVD	1 x 2	4

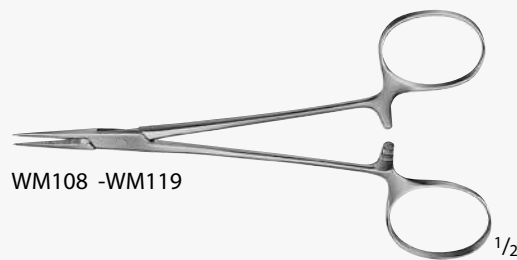

WM108 -WM119

1/2



1/1

WM108



1/1

WM109



1/1

WM118



1/1

WM119

Micro HALSTED Mosquito Forceps, Delicate

Catalog Number	Jaw	Teeth	Length (in.)
WM108	STR	-	5
WM118	STR	1 x 2	5
WM109	CVD	-	5
WM119	CVD	1 x 2	5

INCHES



WM110 -WM121



WM110

WM120



WM111

WM121



WM210 -WM215

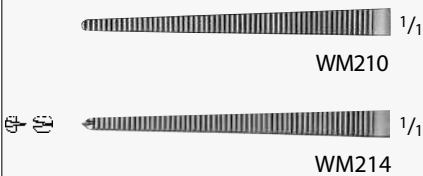

WM210

WM214

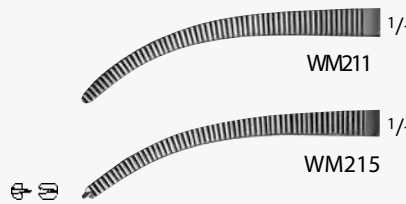

WM211

WM215

HALSTED Mosquito Forceps, Delicate

Catalog Number	Jaw	Teeth	Length (in.)
WM110	STR	-	5
WM120	STR	1 x 2	5
WM210	STR	-	7 7/8
WM214	STR	1 x 2	7 7/8
WM111	CVD	-	5
WM121	CVD	1 x 2	5
WM211	CVD	-	7 7/8
WM215	CVD	1 x 2	7 7/8

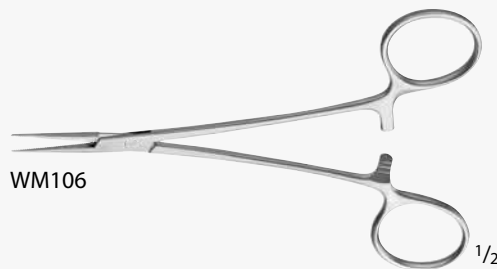

WM106



WM106

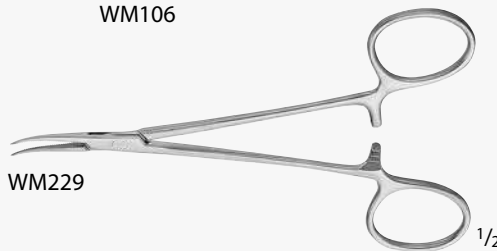

WM229



WM229

JACOBSON Mosquito Forceps

Catalog Number	Jaw	Length (in.)
WM106	STR	5 1/8
WM229	CVD	5

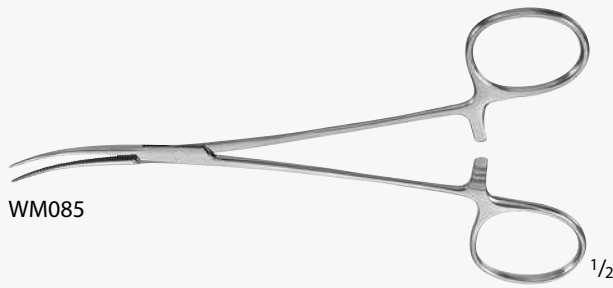

WM085



WM085

Mosquito Forceps

Catalog Number	Jaw	Length (in.)
WM085	DEL, CVD.	6

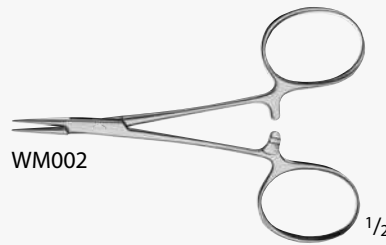

WM002

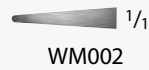

WM002

Suture Forceps

Catalog Number	Tip	Jaw	Length (in.)
WM002	SMOOTH	STR	3 3/4

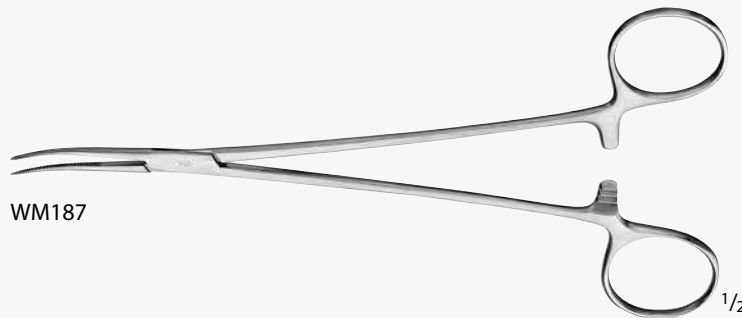

WM187



WM187

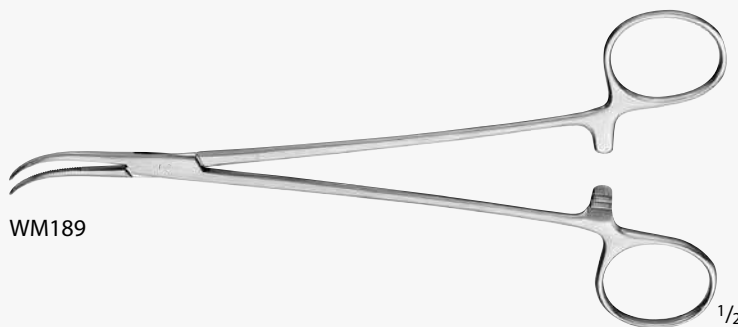

WM189



WM189

JACOBSON Hemostatic Forceps

Catalog Number	Jaw	Length (in.)
WM187	SLIGHT-CVD	7 1/2
WM189	HEAVY-CVD	7 1/2

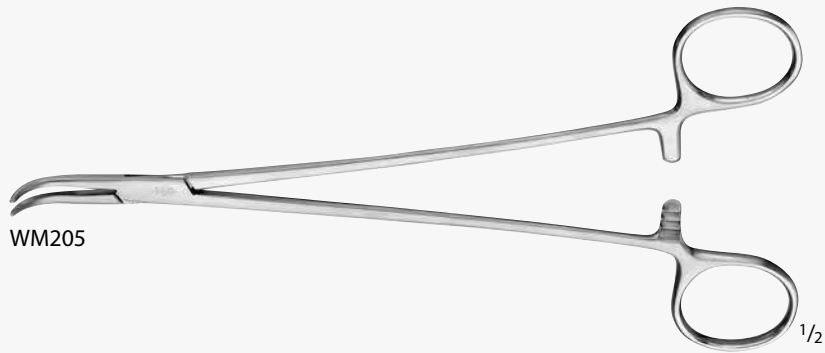

WM205



WM205

ADSON Hemostatic Forceps

Catalog Number	Jaw	Length (in.)
WM205	CVD	8 1/2

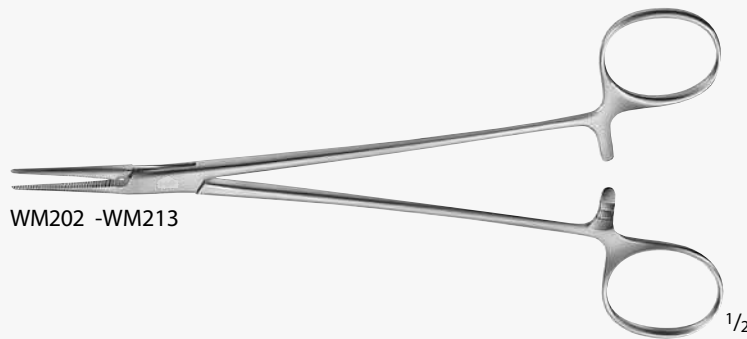

WM202 -WM213



WM202



WM203



WM212



WM213

HALSTED Forceps Delicate

Catalog Number	Jaw	Teeth	Length (in.)
WM202	STR	-	7 1/4
WM212	STR	1 x 2	7 1/4
WM203	CVD	-	7 1/4
WM213	CVD	1 x 2	7 1/4

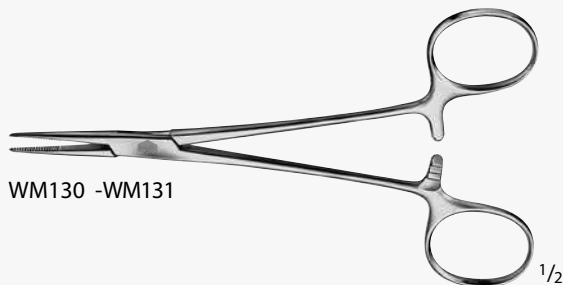

WM130 -WM131



WM130



WM131

PROVIDENCE Hospital Forceps, Delicate

Catalog Number	Jaw	Length (in.)
WM130	STR	5 1/2
WM131	CVD	5 1/2

INCHES

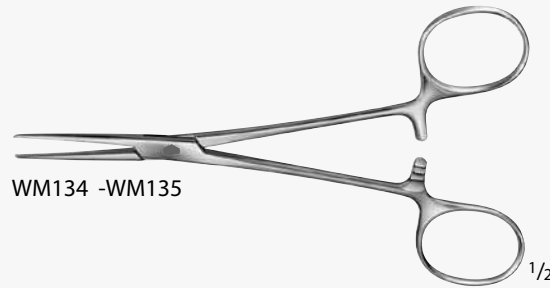

WM134 -WM135



WM134



WM135

**KELLY Forceps**

Catalog Number	Jaw	Length (in.)
WM134	STR	5 1/2
WM135	CVD	5 1/2

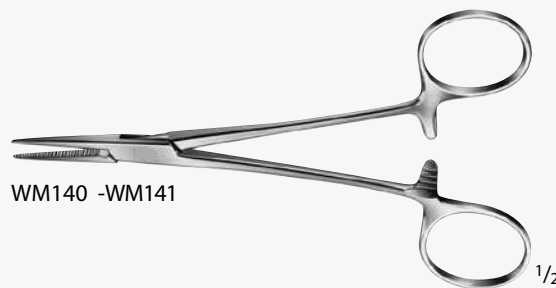

WM140 -WM141



WM140



WM141

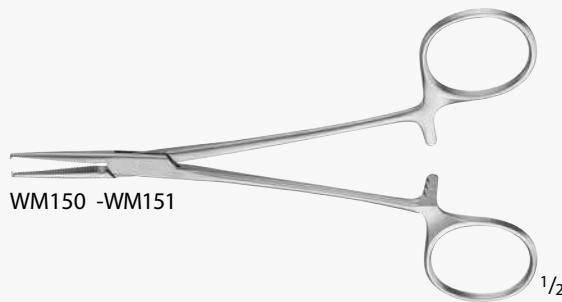

WM150 -WM151



WM150



WM151

**Baby CRILE Forceps**

Catalog Number	Jaw	Teeth	Length (in.)
WM140	STR	-	5 1/2
WM150	STR	1 x 2	5 1/2
WM141	CVD	-	5 1/2
WM151	CVD	1 x 2	5 1/2

WM144 -WM155

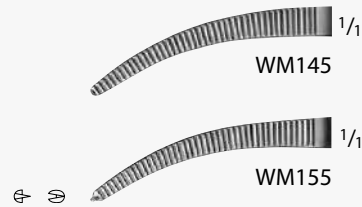
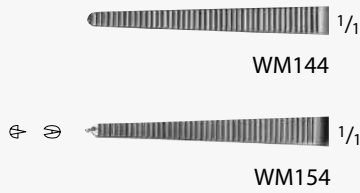

WM166 -WM177

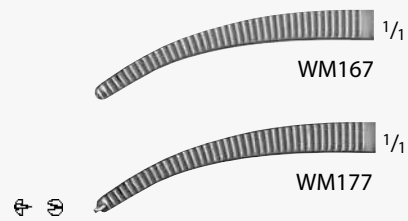
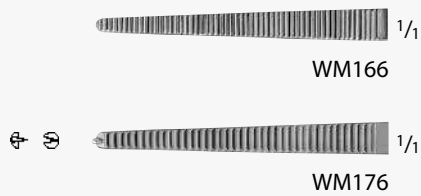

CRILE Forceps

Catalog Number	Jaw	Teeth	Length (in.)
WM144	STR	-	5 1/2
WM154	STR	1 x 2	5 1/2
WM166	STR	-	6 1/4
WM176	STR	1 x 2	6 1/4
WM145	CVD	-	5 1/2
WM155	CVD	1 x 2	5 1/2
WM167	CVD	-	6 1/4
WM177	CVD	1 x 2	6 1/4



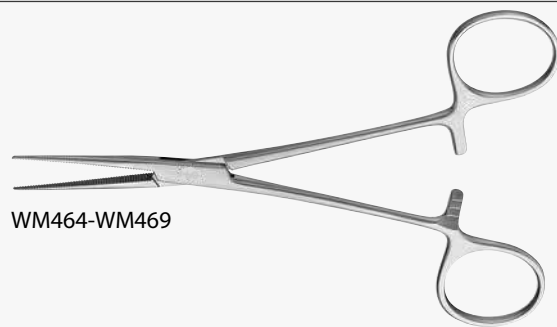

WM464-WM469



WM464



WM466



WM468



WM465



WM467



WM469

COLLER Artery Forceps

Catalog Number	Jaw	Length (in.)
WM464	STR	5 3/4
WM466	STR	6 1/2
WM468	STR	7
WM465	CVD	5 3/4
WM467	CVD	6 1/2
WM469	CVD	7

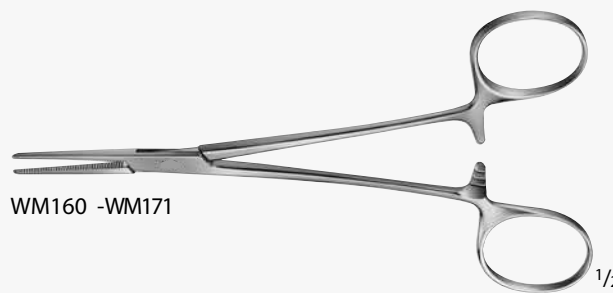

WM160 -WM171



WM160



WM170



WM161



WM171

LERICHE Forceps, Delicate

Catalog Number	Jaw	Teeth	Length (in.)
WM160	STR	-	6
WM170	STR	1 x 2	6
WM161	CVD	-	6
WM171	CVD	1 x 2	6

INCHES



RANKIN Forceps, Delicate

Catalog Number	Jaw	Length (in.)
WM164	STR	6 1/4
WM165	CVD	6 1/4

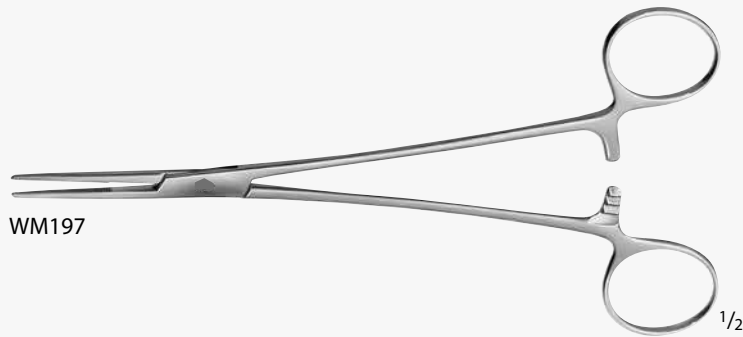

BIRKETT Hemostatic Forceps

Catalog Number	Jaw	Length (in.)
WM197	CVD	7 1/4

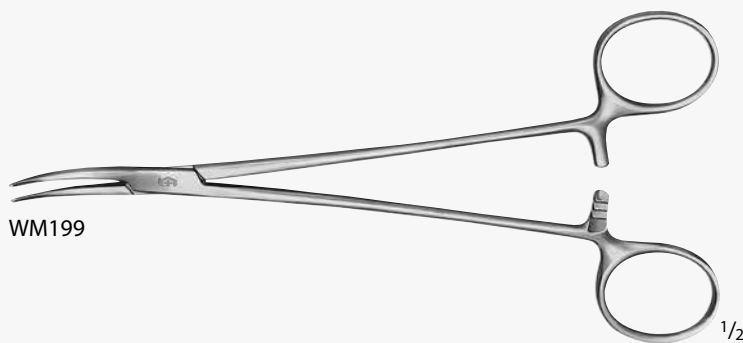

NISSEN Tonsil Forceps, Delicate

Catalog Number	Jaw	Length (in.)
WM199	CVD	7 1/4

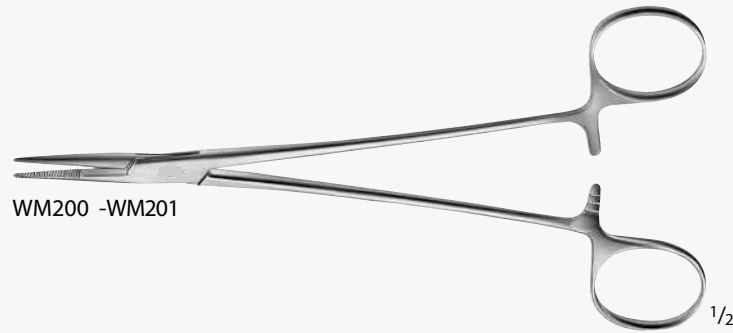

WM200 -WM201



WM200



WM201

ADSON Tonsil Forceps, Delicate

Catalog Number	Jaw	Length (in.)
WM200	STR	7 1/4
WM201	CVD	7 1/4



WM206 -WM217



WM206



WM216



WM207



WM217



WM209

HEISS Forceps, Delicate

Catalog Number	Jaw	Teeth	Length (in.)
WM206	STR	-	7 7/8
WM216	STR	1 x 2	7 7/8
WM207	CVD	-	7 7/8
WM217	CVD	1 x 2	7 7/8
WM209	HVY-CVD	-	7 3/4

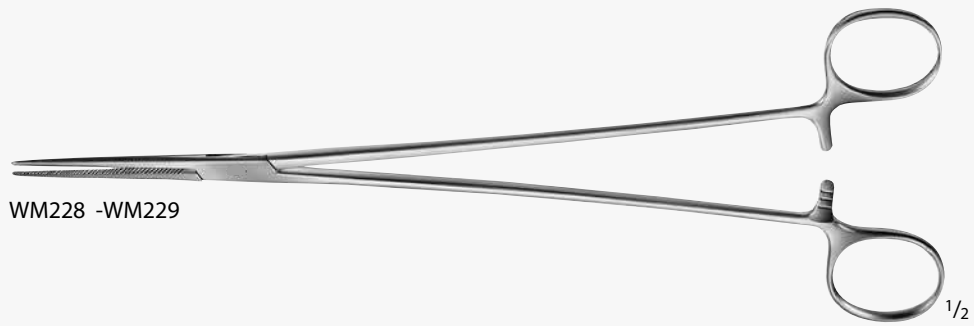

BENGOLEA Forceps, Delicate

Catalog Number	Jaw	Length (in.)
WM228	STR	9 5/8
WM229	CVD	9 5/8

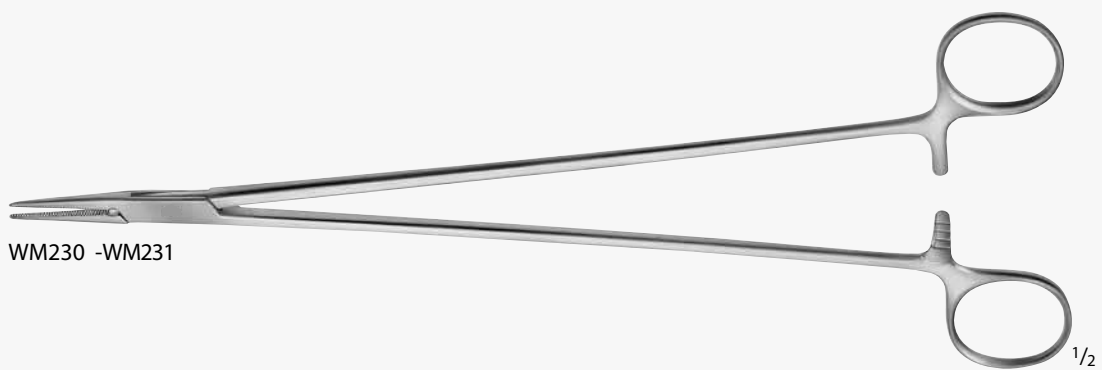

BRIDGE Forceps, Delicate

Catalog Number	Jaw	Length (in.)
WM230	STR	10 3/4
WM231	CVD	10 3/4

INCHES

1  
2  
3  
4  
5  
6  
7  
8  
9  
10  
11

WM100 -WM106

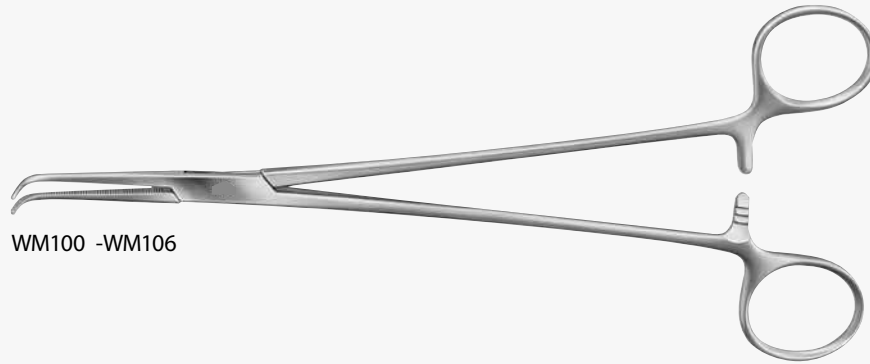

WM100



WM104



WM102



QW106C



WM103

GEMINI Right Angle Forceps

Catalog Number	Length (in.)
WM100	5 1/2
WM102	7
WM103	7 7/8
WM104	9
WM106	11

WM037 -WM039



WM037



WM038



QW039C

HOLLE Forceps, Delicate

Catalog Number	Length (in.)
WM037	5 3/4
WM038	7 1/4
WM039	9 1/4



WM058

1/2



WM058

1/1



WM057 -WM059



WM057

1/1



WM058

1/1



WM059

1/1

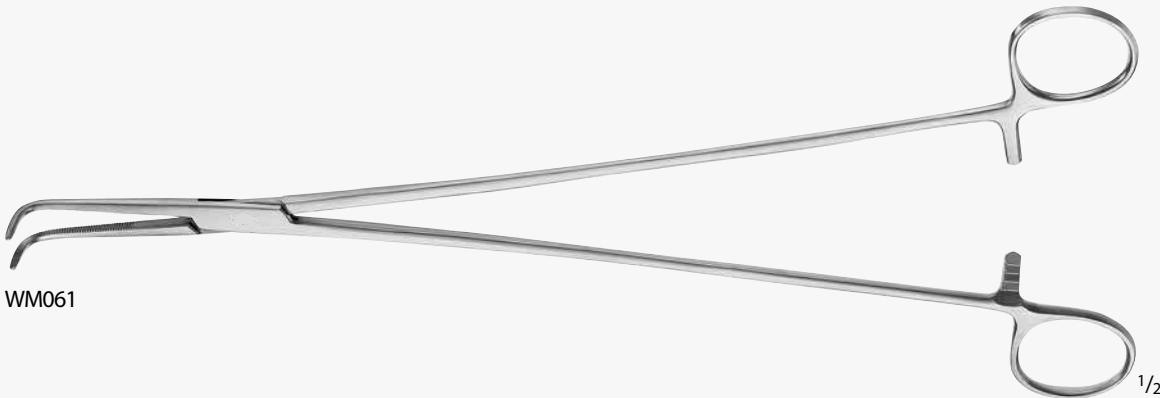

WM061

1/2



WM061

1/1

KANTROWITZ Right Angle Forceps

Catalog Number	Length (in.)
WM058	6 3/8
WM057	7 7/8
WM 058	9 5/8
WM059	10 3/4
WM061	12

INCHES

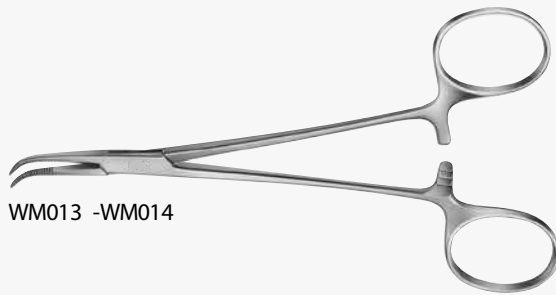

Baby ADSON Forceps

Catalog Number	Length (in.)
WM013	5 1/2
WM014	7

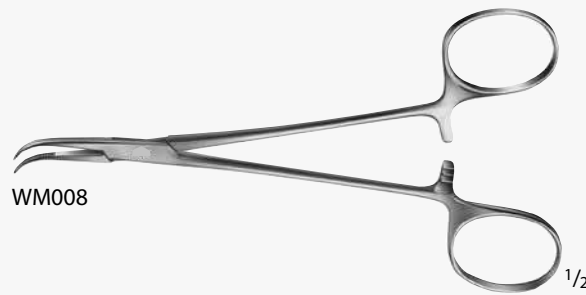

Micro ADSON Suture Forceps

Catalog Number	Length (in.)
WM008	5 1/2

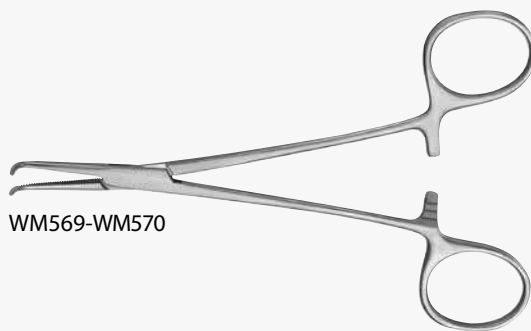

MIXTER (MEEKER) Right Angle Forceps

Catalog Number	Length (in.)
WM569	5 1/2
WM570	7



WM020 - WM035



WM020



WM021,  
WM031



WM022,  
WM032



WM023,  
WM033



WM024,  
WM034



WM025,  
WM035



WM026

OVERHOLT-GEISSENDOERFER Forceps

Catalog Number	Jaw Curve (#)	Length (in.)
WM020	0	7 3/4
WM021	1	8
WM022	2	8 3/4
WM023	3	8 7/8
WM024	4	8 3/4
WM025	5	9
WM026	6	8 7/8
WM031	1	10 1/4
WM032	2	10 5/8
WM033	3	10 3/4
WM034	4	10 5/8
WM035	5	11



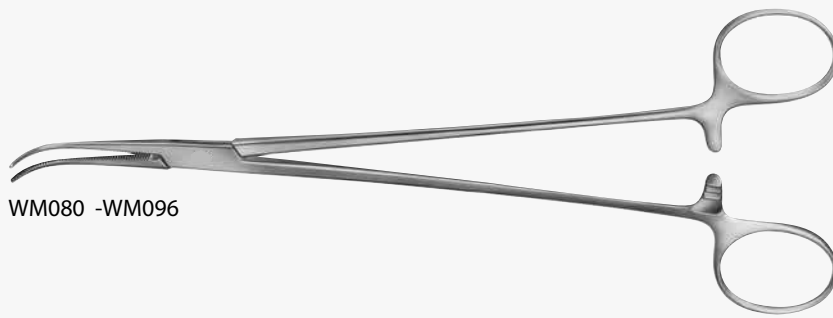

WM080 - WM096



WM080 <sup>1/1</sup>

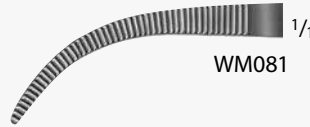

WM081 <sup>1/1</sup>



WM082 <sup>1/1</sup>



WM083 <sup>1/1</sup>



WM086 <sup>1/1</sup>



WM090 <sup>1/1</sup>



WM091 <sup>1/1</sup>



WM096 <sup>1/1</sup>



OVERHOLT Forceps

Catalog Number	Jaw Curve (#)	Length (in.)
WM080	0	8 1/2
WM081	1	8 1/4
WM082	2	8 3/4
WM083	3	8 7/8
WM086	6	8 7/8
WM090	0	11 5/8
WM091	1	11 5/8
WM096	6	11 3/4

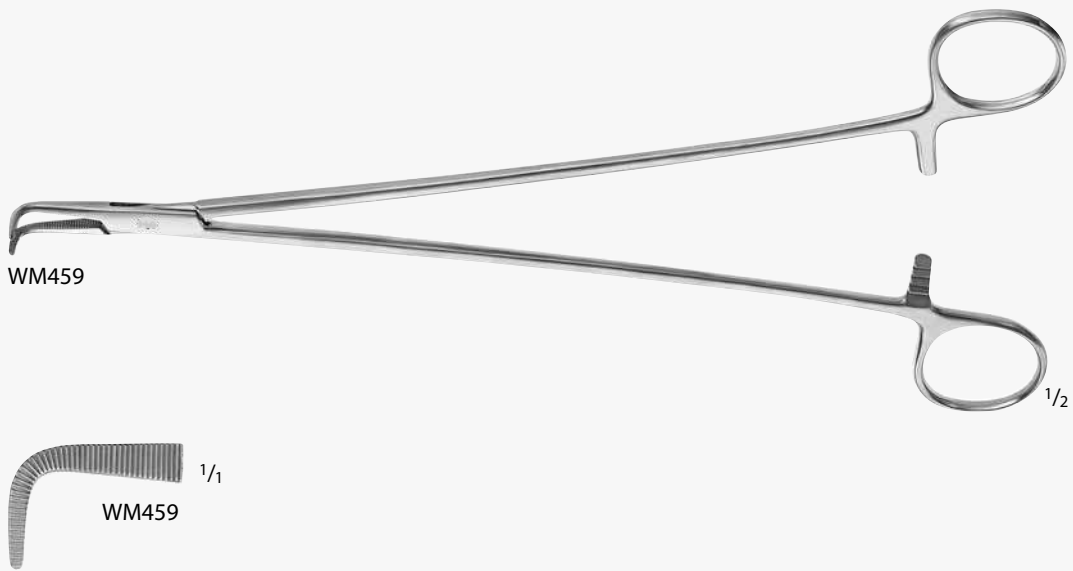

MEEKER Forceps

Catalog Number	Length (in.)
WM459	11

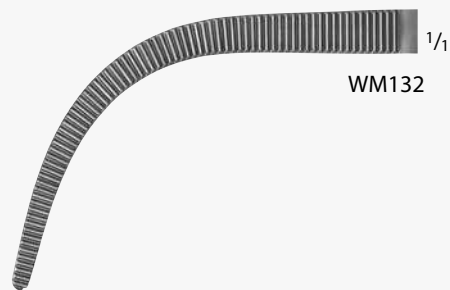
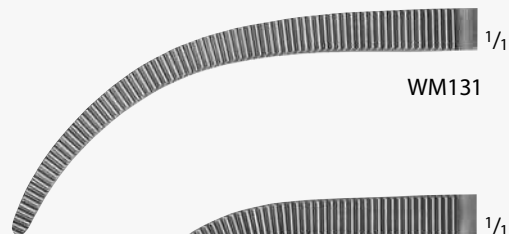
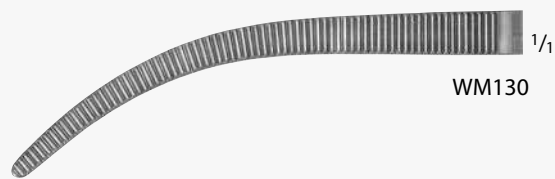
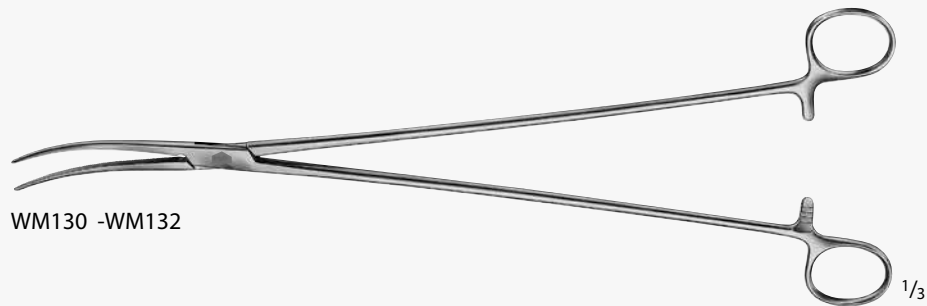
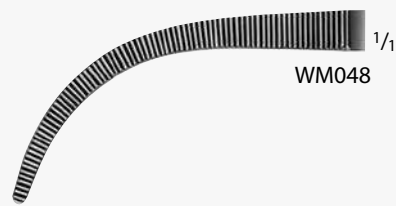
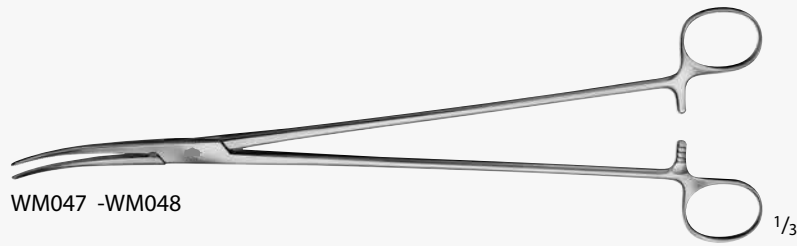

ZENKER Ligature Forceps

Catalog Number	Jaw	Length (in.)
WM047	SLIGHT-CVD	11 3/4
WM048	HEAVY-CVD	11 1/2
WM130	SLIGHT-CVD	13 3/4
WM131	CVD	13 3/4
WM132	HEAVY-CVD	13 3/4

## Dissecting and Right Angle Forceps

WWW.WYZZMEDICAL.COM



MIXTER-O'SHAUGHNESSY Forceps

Catalog Number	Length (in.)
WM050	7 1/2

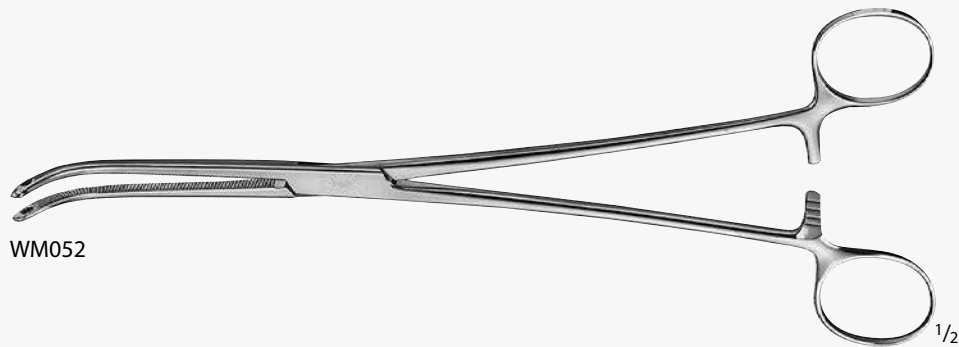

FINOCHIETTO Forceps

Catalog Number	Length (in.)
WM052	9 5/8



Dissecting and Right Angle Forceps

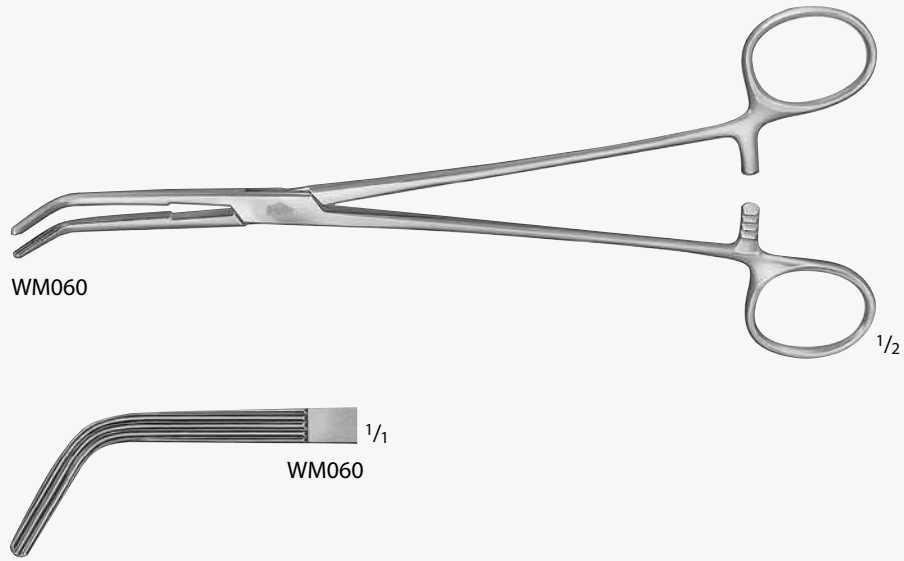

WM060

1/2

WM060

1/1

LAHEY Forceps

Catalog Number	Length (in.)
WM060	8 7/8

WWW.WYZZMEDICAL.COM

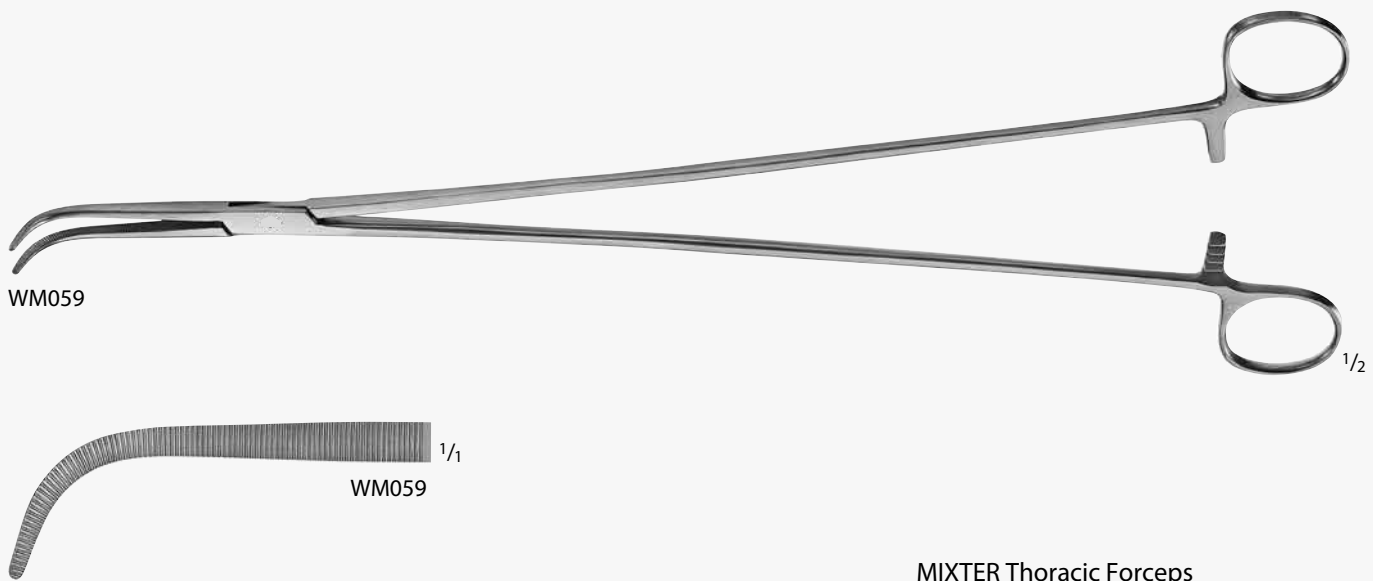

WM059

1/2

WM059

1/1

MIXTER Thoracic Forceps

Catalog Number	Length (in.)
WM059	14

Dissecting and Right Angle Forceps



WM061 - WM062



WM061



WM062

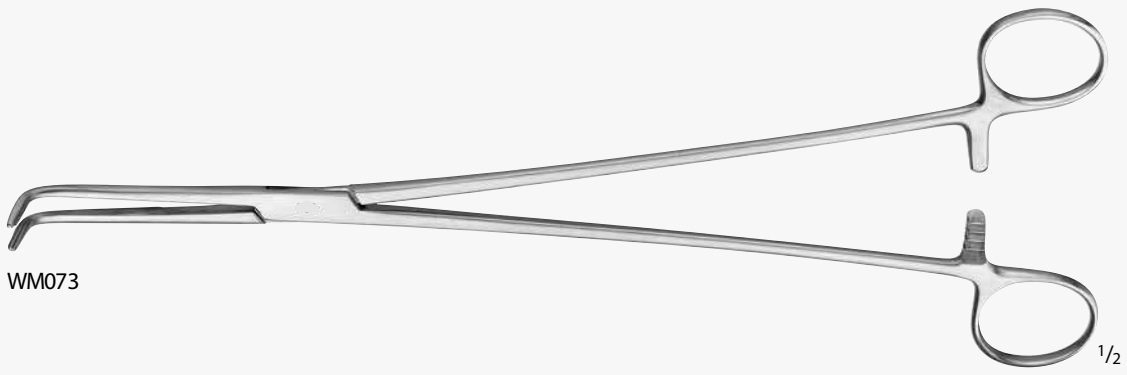

WM073

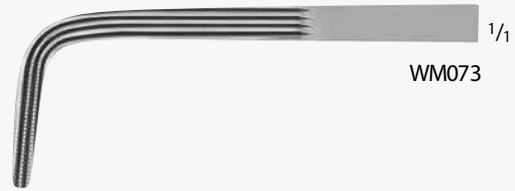

WM073



MIXTER Forceps, Longitudinal Serrations

Catalog Number	Length (in.)
WM061	8 3/4
WM062	9 3/4
WM073	11 1/2

Dissecting and Right Angle Forceps

WWW.WYZZMEDICAL.COM

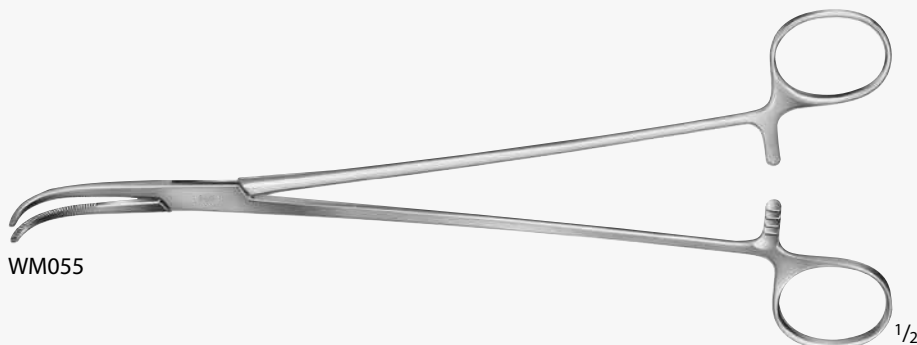

WM055



WM055

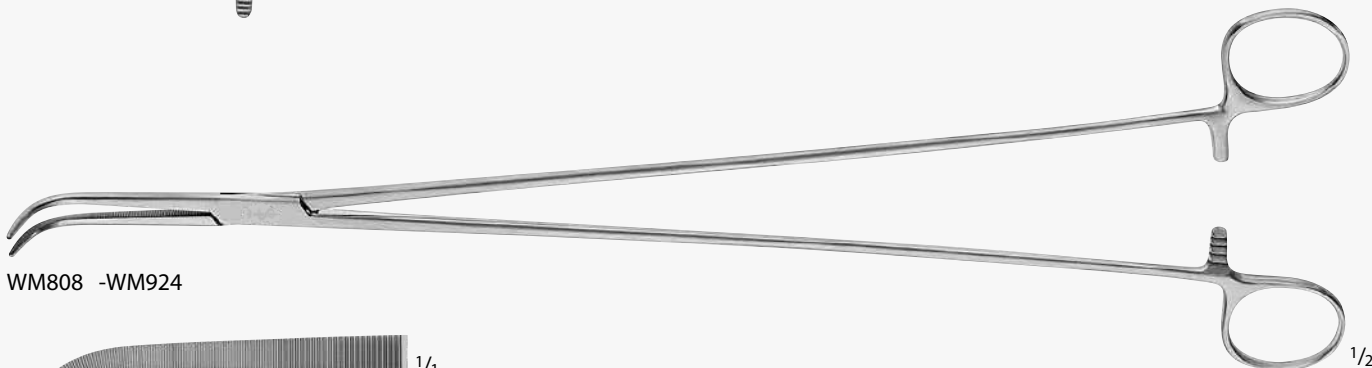

WM808 -WM924



WM808

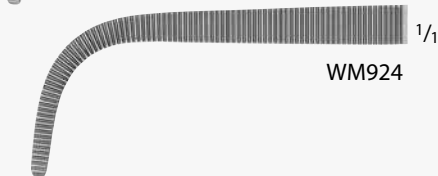

WM924

MIXTER Forceps

Catalog Number	Length (in.)
WM055	9
WM808	14
WM924	15 3/4

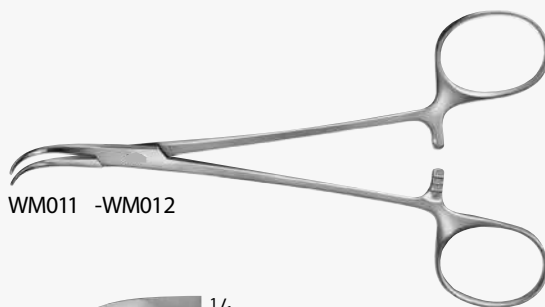

WM011 -WM012



WM011



WM012

Baby MIXTER Forceps

Catalog Number	Length (in.)
WM011	5 1/2
WM012	7

INCHES



Dissecting and Right Angle Forceps

WWW.WYZZMEDICAL.COM

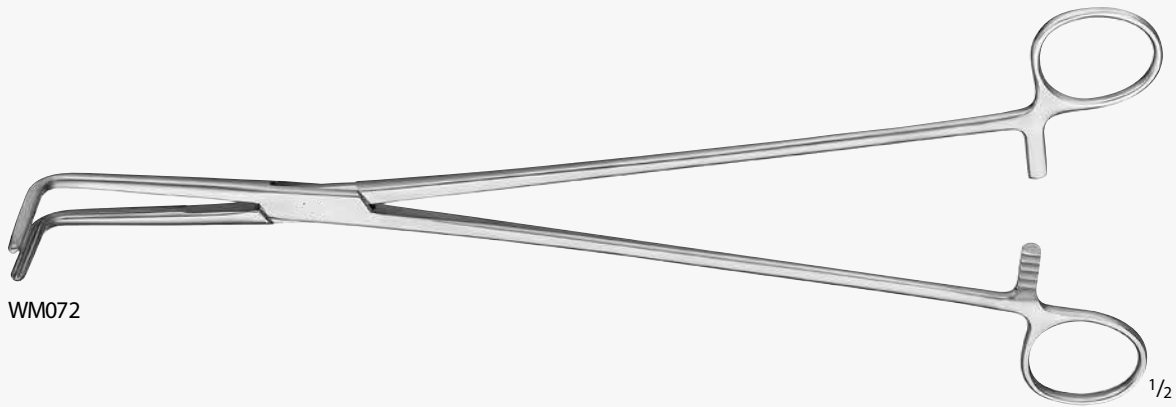

WM072

1/2



WM072

1/1

HARRINGTON-MIXTER Forceps,  
Longitudinal Serrations

Catalog Number	Length (in.)
WM072	12 1/2

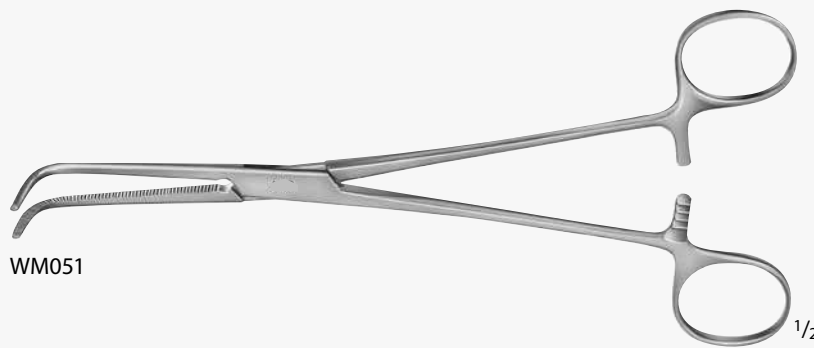

WM051

1/2



WM051

1/1

WIKSTROEM Forceps

Catalog Number	Length (in.)
WM051	8

INCHES

1  
2  
3  
4  
5  
6  
7  
8  
9  
10  
11

Dissecting and Right Angle Forceps

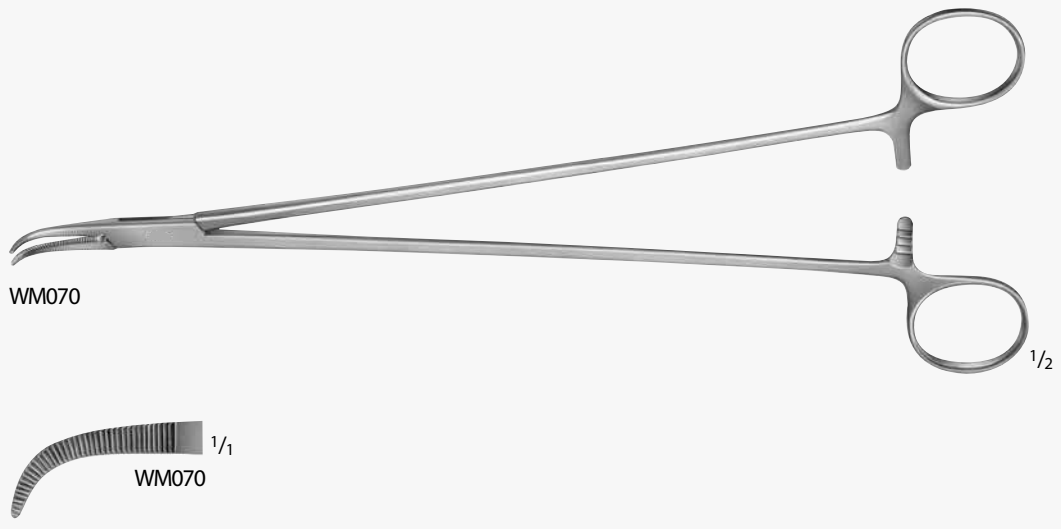

LAWRENCE Forceps

Catalog Number	Length (in.)
WM070	10 5/8

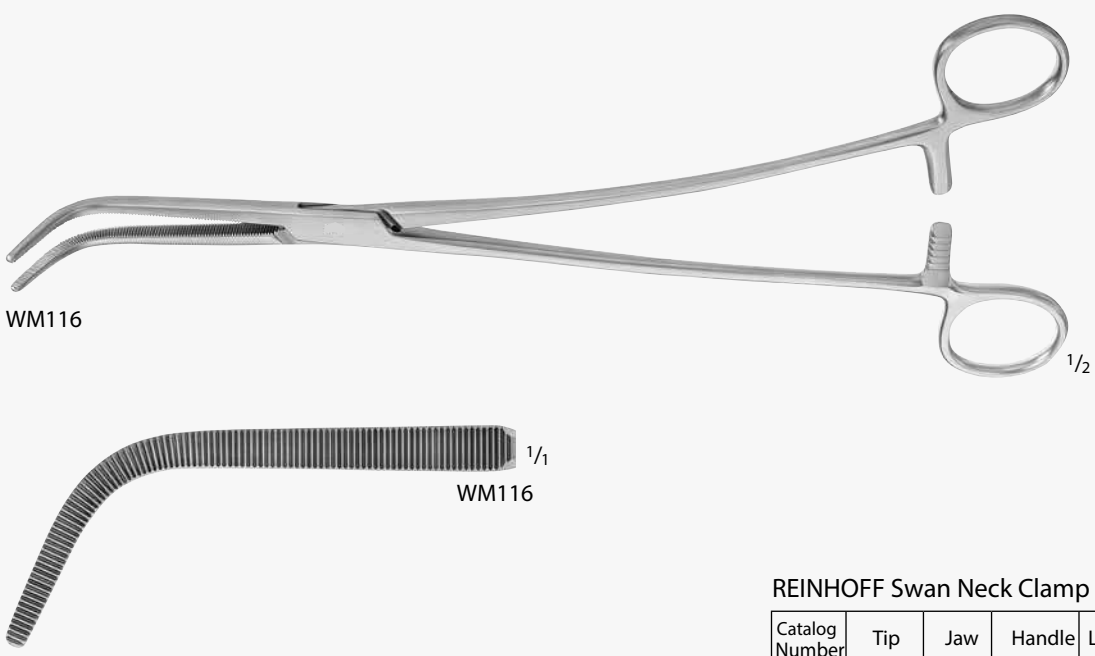

REINHOFF Swan Neck Clamp

Catalog Number	Tip	Jaw	Handle	Length (in.)
WM116	SERR	CVD	CVD	10 1/4

WWW.WYZZMEDICAL.COM



Dissecting and Right Angle Forceps



KIEBACK Forceps <sup>1/2</sup>

Catalog Number	Jaw	Length (in.)
WM075	CVD, LONGITUDINAL SERR	9 1/4

INCHES



WWW.WYZZMEDICAL.COM

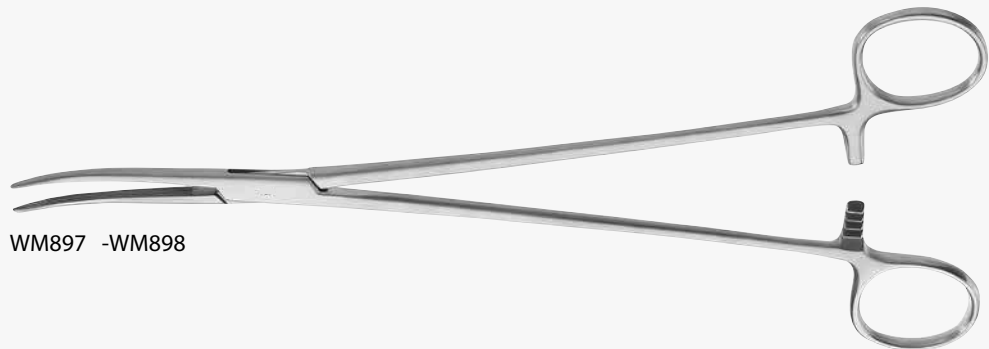

WM897 -WM898

WM897 -WM898

COLLIER-ANDERSON Forceps

Catalog Number	Jaw	Length (in.)
WM897	CVD, LONGITUDINAL SERR	10
WM898	CVD, LONGITUDINAL SERR	11

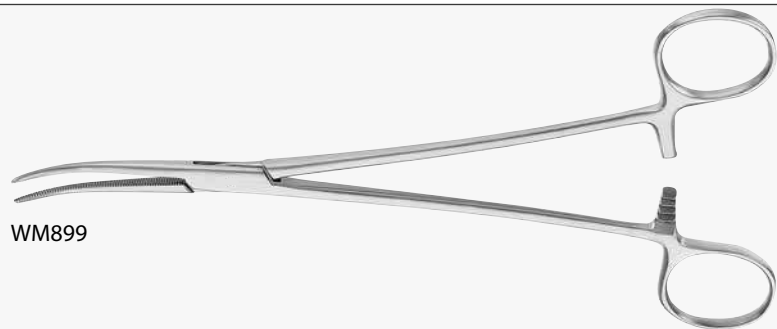

WM899

WM899

DEBAKEY-COLLIER Forceps

Catalog Number	Jaw	Length (in.)
WM899	CVD, SERR	8



WM407

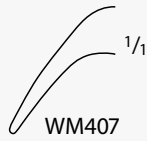

WM407

JONES Towel Clamp

Catalog Number	Length (in.)
WM407	3 1/4



WM426

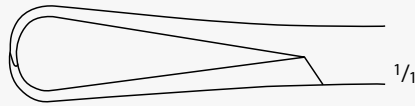

WM426

BERNHARD Towel Clamp

Catalog Number	Length (in.)
WM426	6 1/4



WM431 -WM433



WM431

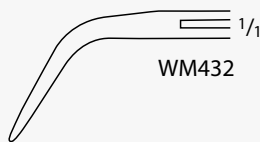

WM432

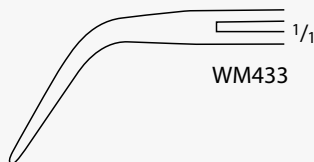

WM433

BACKHAUS Towel Clamp

Catalog Number	Length (in.)
WM431	3 1/2
WM432	4 1/4
WM433	5 1/4

INCHES



INCHES

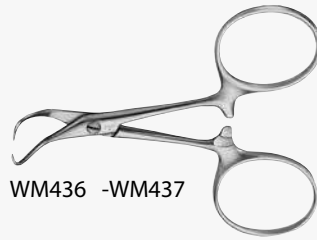

WM436 -WM437

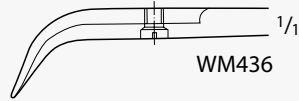

WM436

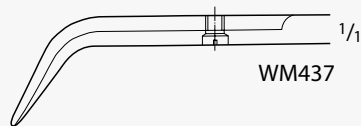

WM437

BACKHAUS Towel Clamp, W/ Screw

Catalog Number	Length (in.)
WM436	3 1/8
WM437	4 1/8



WM444

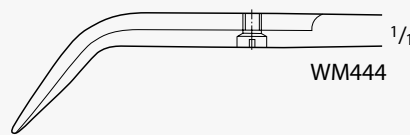

WM444

BACKHAUS-KOCHER Towel Clamp, W/ Screw

Catalog Number	Length (in.)
WM444	5 1/4



WM448

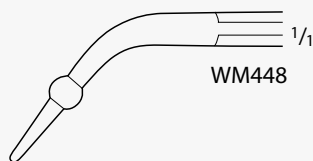

WM448

ROEDER Towel Clamp, W/ Ball On Jaws

Catalog Number	Length (in.)
WM448	5 1/4

INCHES



WM464



WM464

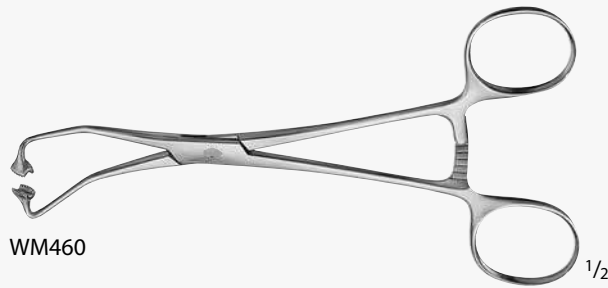

WM460

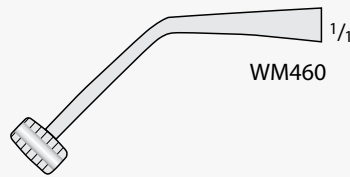

WM460

Towel Clamp, Paper Drape

Catalog Number	Length (in.)
WM464	5 1/2
WM460	6

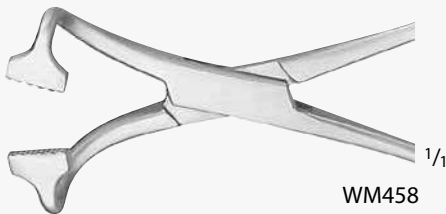

WM458

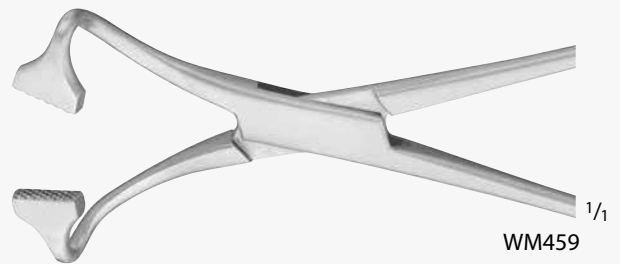

WM459

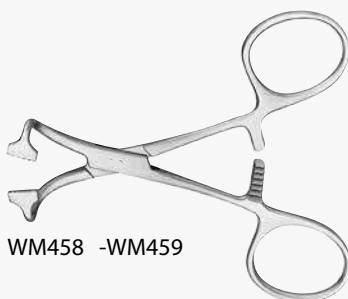

WM458 -WM459

Non-Perforating Towel Forceps

Catalog Number	Length (in.)
WM458	4
WM459	5 1/2

1  
2  
3  
4  
5  
6  
7  
8  
9  
10  
11



LORNA Non-Perforating Towel Clamp

Catalog Number	Length (in.)
WM461	3 $\frac{3}{4}$
WM463	5 $\frac{1}{8}$

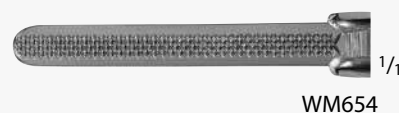
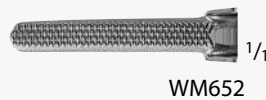

Tubing Clamp, W/ Guard

Catalog Number	Jaw	Length (in.)
WM652	SERR	6
WM653	SERR	7
WM654	SERR	7 $\frac{7}{8}$



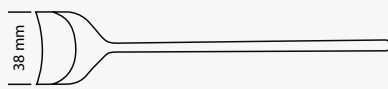
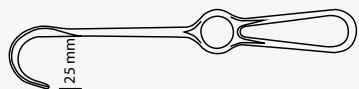

Dimensions for blade size of retractors  
 1st number = depth      Example: 25 x 38 mm  
 2nd number = width



WM620 , WM185 , WM622 -WM624C , WM581



**JOSEPH Skin Hook**

Catalog Number	Tip	Prongs	Tip Size (mm)	Length (in.)
WM620	SHARP	1	-	6 1/2
WM185	SHARP	2	2	6 1/4
WM622	SHARP	2	3	6 1/2
WM623	SHARP	2	6	6 1/2
WM624	SHARP	2	8	6 1/2
WM581	SHARP	2	10	6 1/2



**FREER Double Hook**

Catalog Number	Tip	Tip Size (mm)	Length (in.)
WM621	SHARP	2.0 x 3.2	6

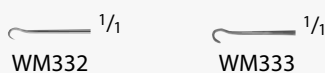

**GRAEFE Hook**

Catalog Number	Tip	Length (in.)
WM332	SHARP	5
WM333	BLUNT	5

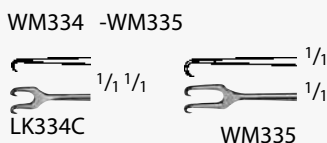

**GUTHRIE Double Hook**

Catalog Number	Tip	Length (in.)
WM334	SHARP	5
WM335	SHARP	5 1/8



WM336 -WM338

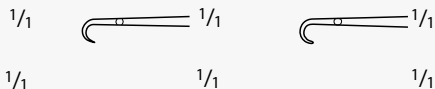

WM336C      WM337      WM338

**ROLLET Hook Retractor**

Catalog Number	Tip	Blade End	Tip Size (mm)	Length (in.)
WM36	SHARP	2 PRONGS	2.2 x 4.5	5 1/8
WM337	SHARP	4 PRONGS	2.5 x 7.0	5 1/4
WM338	BLUNT	4 PRONGS	2.2 x 7.0	5 1/4

**MCINDOE Hook**

Catalog Number	Tip	Blade End	Tip Size (mm)	Length (in.)
WM615=	SHARP	2 PRONGS	9	6

**PAUL Tendon Hook**

Catalog Number	Tip	Blade End	Tip Size (mm)	Length (in.)
WM340	BLUNT	3 PRONGS	11 x 8	4 3/4

**JAEGER Hook Retractor, Fine**

Catalog Number	Tip	Length (in.)
WM351	SHARP	5 1/4

**KILNER Skin Hook**

Catalog Number	Tip	Length (in.)
WM610	SHARP	6 1/4

**GILLIES Skin Hook**

Catalog Number	Tip	Hook End	Length (in.)
WM611	SHARP	SMALL	7
WM612	SHARP	LARGE	7

WM615

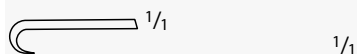

WM615

WM340

1/1

WM340

1/1

WM351

1/1

WM351

WM610C

1/1

WM610

WM611 -WM612

WM611 1/1

WM612 1/1

WM612

1/2

1/2

1/2

1/2

1/2



# General Surgery

## Skin Hooks

# Wyzz Medical<sup>©</sup>

WWW.WYZZMEDICAL.COM

WM617  $\frac{1}{2}$   
 WM617  $\frac{1}{1}$

### COTTLE Hook

Catalog Number	Tip	Hook End	Length (in.)
WM617	SHARP	ANG	6 1/4
WM619	SHARP	HVY-CVD	6 1/4

WM619  $\frac{1}{2}$   
 WM619  $\frac{1}{1}$

WM601 -WM603  $\frac{1}{2}$   
 WM601  $\frac{1}{1}$   
 WM602  $\frac{1}{1}$   
 WM603  $\frac{1}{1}$

### KLEINERT-KUTZ Skin Hook

Catalog Number	Size	Tip	Tip Size (mm)	Length (in.)
WM601			1	SHARP 2.5
WM602			2	SHARP 4.2
WM603			3	SHARP 4.8

WM885 -WM887  $\frac{1}{2}$

### Prong Micro Hooks

Catalog Number	Tip	Tip Size (mm)	Length (in.)
WM885	SHARP	1	5 5/8
WM886	SHARP	2	5 5/8
WM887	BLUNT	2	5 5/8
WM888	SHARP	2	5 5/8
WM889	SHARP	5	5 5/8
WM890	SHARP	7	5 5/8
WM891	SHARP	10	5 5/8

WM888 -WM891  $\frac{1}{2}$



WM075  $\frac{1}{2}$   
WM075  $\frac{1}{1}$

**BROM Vein Hook**

Catalog Number	Length (in.)
WM075	6 3/4

WM100  $\frac{1}{2}$   
WM100  $\frac{1}{1}$

**BERGMANN Hook**

Catalog Number	Tip	Tip Size (mm)	Length (in.)
WM100	SHARP	7	5 1/2

WM161  $\frac{1}{2}$   
WM161  $\frac{1}{1}$

**EMMET Fistula Hook**

Catalog Number	Tip	Length (in.)
WM161	SHARP	8 3/4

WM166  $\frac{1}{2}$   
WM166  $\frac{1}{1}$   
WM167  $\frac{1}{2}$   
WM167  $\frac{1}{1}$

**SIMON Fistula Hook**

Catalog Number	Tip	Blade End	Length (in.)
WM166	SHARP	1 PRONG	8 3/4
WM167	SHARP	2 PRONGS	8 3/4

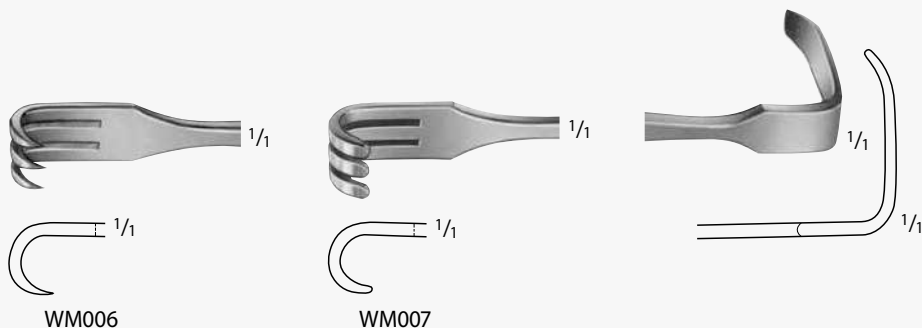

Baby SENN-MILLER Retractor,  
Flat Handle

Catalog Number	Tip	Blade End	Blade Size (mm)	Length (in.)
WM006	SHARP	3 PRONGS	8 x 7 / 22 x 7	6 1/8
WM007	BLUNT	3 PRONGS	8 x 7 / 22 x 7	6 1/8

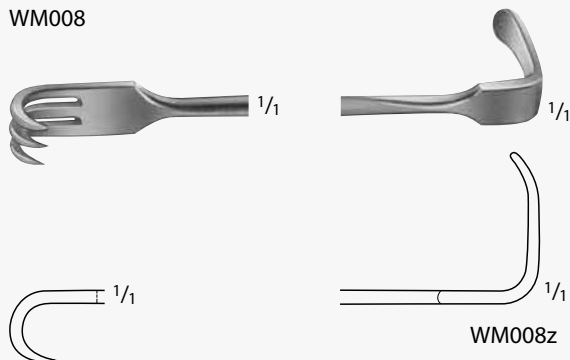

SENN-MILLER Retractor

Catalog Number	Tip	Blade End	Blade Size (mm)	Length (in.)
WM008	SHARP	3 PRONGS	8 x 7 / 18 x 5.5	6 1/2

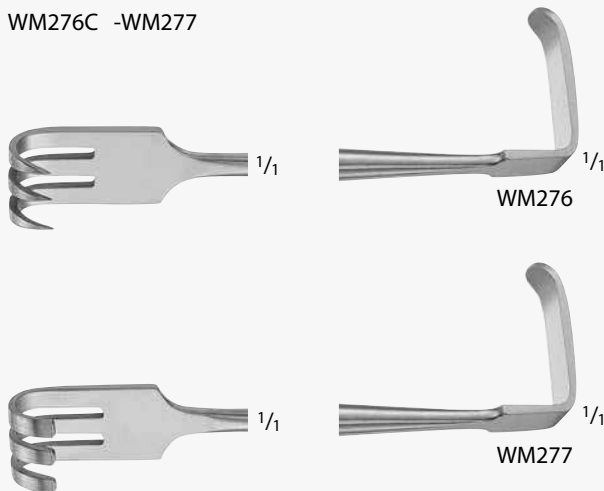

SENN Retractor, Round Tapered Handle

Catalog Number	Tip	Blade End	Blade Size (mm)	Length (in.)
WM276	SHARP	3 PRONGS	9 x 10 / 22 x 7	6 1/4
WM277	BLUNT	3 PRONGS	9 x 10 / 22 x 7	6 1/4



WM004, WM274

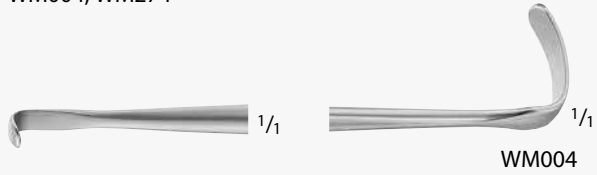

WM004

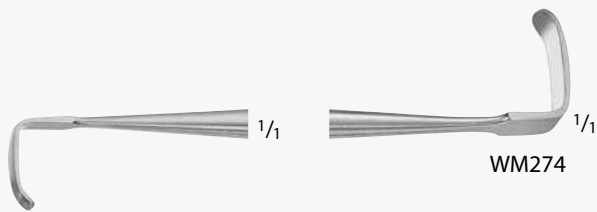

WM274

RAGNELL Retractor

Catalog Number	Blade Size (mm)	Length (in.)
WM004	3 x 5 / 6.3 x 14	6
WM274	3 x 11 / 5.4 x 17	6



WM475

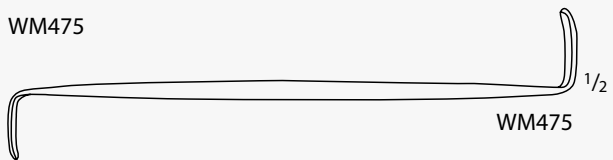

WM475

DAVIS Double Ended Retractor

Catalog Number	Blade Size (mm)	Length (in.)
WM475	19 x 9 / 23 x 6.4	6



WM187

Double Ended Retractor

Catalog Number	Blade Size (mm)	Length (in.)
WM187	20 x 15 / 20 x 19	8



WM497

GOELET Retractor

Catalog Number	Blade Size (mm)	Length (in.)
WM497	30 x 32 / 35 x 40	7 1/2



WM010 <sup>1/2</sup>



WM010 <sup>1/2</sup>

**LUER Retractor**

Catalog Number	Blade Size (mm)	Length (in.)
WM010	10 x 8 / 12 x 11	4 1/4



WM020 <sup>1/2</sup>



WM020 <sup>1/2</sup>



WM021 <sup>1/2</sup>



WM021 <sup>1/2</sup>

**FARABEUFR Retractor, 2/Set**

Catalog Number	Blade Size (mm)	Length (in.)
WM020	25 x 10 / 32 x 12 22 x 10 / 29 x 12	5
WM021	23 x 16 / 28 x 16 19 x 16 / 24 x 16	6



WM984 <sup>1/2</sup>

**MAYO-COLLINS Retractor, 2/Set**

Catalog Number	Blade Size (mm)	Length (in.)
WM984	31 x 20 / 30 x 18 28 x 19 / 26 x 17	5 7/8





WM022

1/2



WM022

**COLLIN Retractor, 2/Set**

Catalog Number	Blade Size (mm)	Length (in.)
WM022	21 x 14 / 32 x 16 17 x 14 / 28 x 16	6



WM012

1/2

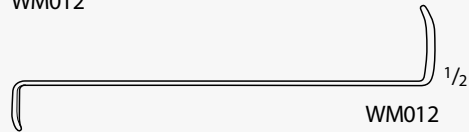

WM012

1/2

**CRILE Retractor**

Catalog Number	Blade Size (mm)	Length (in.)
WM012	11 x 4 / 19 x 6	4 1/4



WM727 -WM733

1/1

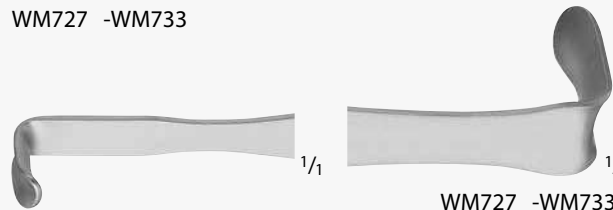

WM727 -WM733

1/1

**CRILE Retractor**

Catalog Number	Size	Blade Size (mm)	Length (in.)

INCHES



WWW.WYZZMEDICAL.COM

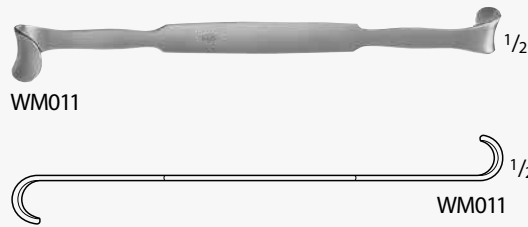

ROSE Tracheal Retractor

Catalog Number	Blade Size (mm)	Length (in.)
WM011	10 x 12 / 11 x 15	5 1/8

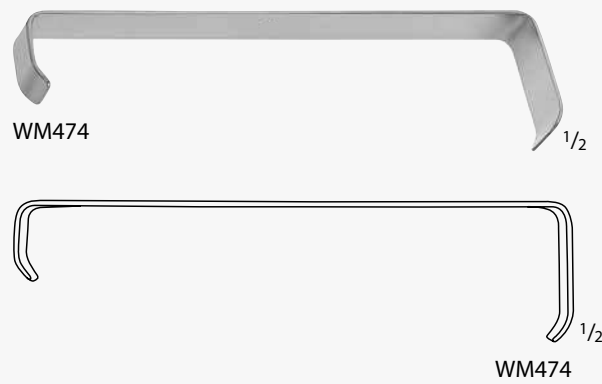

Children's Hospital Retractor

Catalog Number	Blade Size (mm)	Length (in.)
WM474	11 x 22 / 14 x 35	4 1/2

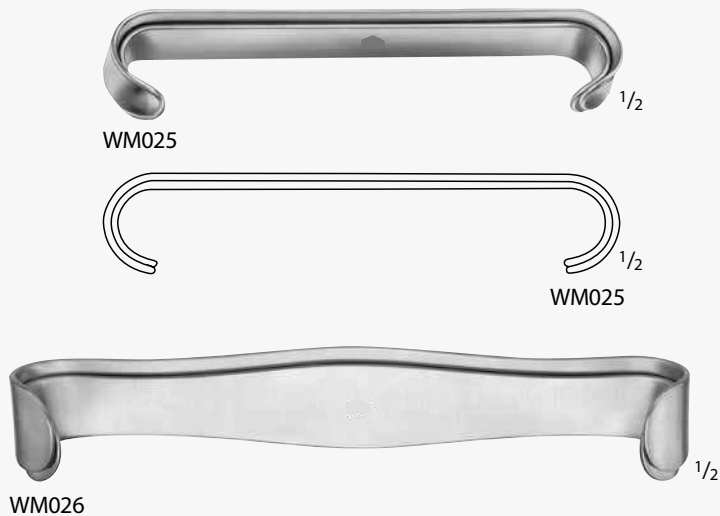

PARKER Retractor, 2/Set

Catalog Number	Blade Size (mm)	Length (in.)
WM025	22 x 15 / 22 x 15 18 x 15 / 18 x 15	5 1/4
WM026	31 x 25 / 27 x 25 31 x 25 / 27 x 25	7





WM034 -WM036

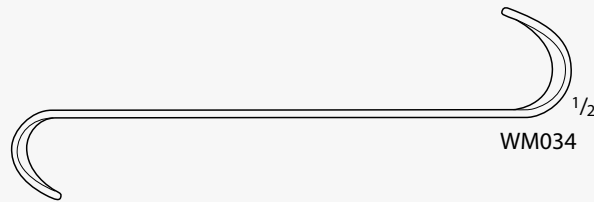

WM034

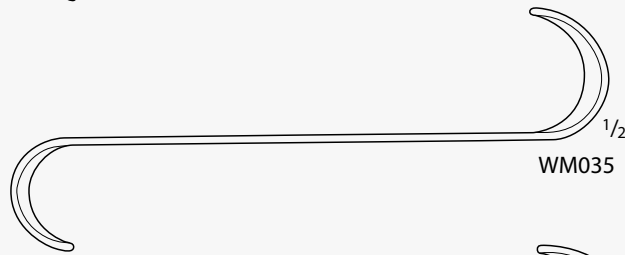

WM035

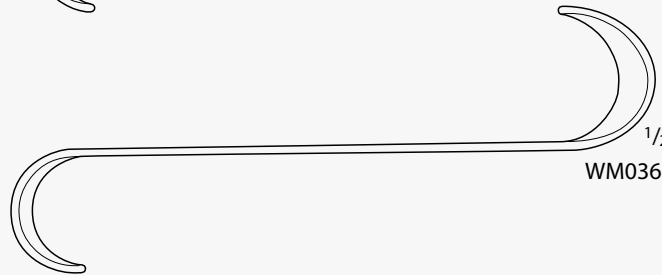

WM036



ROUX Retractor

Catalog Number	Blade Size (mm)	Length (in.)
WM034	20 x 22 / 25 x 29	6
WM035	25 x 26 / 30 x 38	6 1/4
WM036	28 x 29 / 33 x 44	6 3/4



WM030 -WM033



WM031 1/2



WM032 1/2



WM033 1/2

ROUX Retractor

Catalog Number	Blade Size (mm)	Length (in.)
WM030	COMPLETE SET MR031 -MR033	-
WM031	21 x 22 / 27 x 28	5 3/4
WM032	26 x 26 / 32 x 26	6 1/8
WM033	30 x 30 / 36 x 44	6 1/2



WM584 -WM585



WM584 1/2



WM585 1/2

ROUX Retractor

Catalog Number	Blade Size (mm)	Length (in.)
WM584	25 x 26 / 30 x 37	6 1/2
WM585	28 x 28 / 29 x 40	6 1/2



WM029



WM029 1/2

ROUX Retractor, Long

Catalog Number	Blade Size (mm)	Length (in.)
WM029	28 x 28 / 46 x 28	7 1/2



WM040

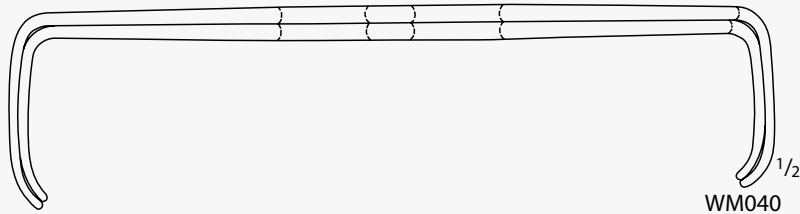

WM040

MATHIEU Retractor, 2/Set

Catalog Number	Blade Size (mm)	Length (in.)
WM040	42 x 13 / 41 x 13 45 x 25 / 40 x 25	7 7/8



WM041



WM041

US Army Retractor, 2/Set

Catalog Number	Blade Size (mm)	Length (in.)
WM041	26 x 15 / 22 x 15 43 x 15 / 39 x 15	8 3/4

INCHES





Hook, Small Curve

Catalog Number	Tip	Blade End	Blade Size (mm)	Length (in.)
WM111	SHARP	1 PRONG	-	6 1/2
WM112	SHARP	2 PRONGS	5.0 x 4.2	6 1/2
WM113	SHARP	3 PRONGS	5.0 x 7.0	6 1/2
WM114	SHARP	4 PRONGS	5.0 x 9.5	6 1/2
WM116	BLUNT	1 PRONG	-	6 1/2
WM117	BLUNT	2 PRONGS	4.5 x 4.2	6 1/2
WM118	BLUNT	3 PRONGS	4.5 x 7.0	6 1/2
WM119	BLUNT	4 PRONGS	4.5 x 9.0	6 1/2

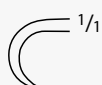

Hook, Large Curve

Catalog Number	Tip	Blade End	Blade Size (mm)	Length (in.)
WM121	SHARP	1 PRONG	-	6 1/2
WM122	SHARP	2 PRONGS	7.5 x 7.5	6 1/2
WM123	SHARP	3 PRONGS	7.5 x 10.0	6 1/2
WM124	SHARP	4 PRONGS	7.5 x 14.0	6 1/2
WM126	BLUNT	1 PRONG	-	6 1/2
WM127	BLUNT	2 PRONGS	6.8 x 7.5	6 1/2
WM128	BLUNT	3 PRONGS	6.8 x 10.0	6 1/2
WM129	BLUNT	4 PRONGS	6.8 x 14.0	6 1/2



WM060

WM060

DP060C

CRILE Hook and Dissector

Catalog Number	Length (in.)
WM060	11 3/4



WM172

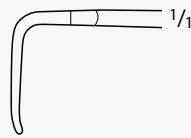

WM172

KLAPP Tendon Hook

Catalog Number	Tip	Blade End	Blade Size (mm)	Length (in.)
WM172	BLUNT	4 PRONGS	15 x 11	6 7/8



WM179

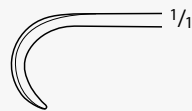

WM179

Vein Retractor

Catalog Number	Blade Size (mm)	Length (in.)
WM179	10 x 13	6 1/4



WM182 -WM183



WM182



MR183C

KOENIG Vein Retractor

Catalog Number	Blade Size (mm)	Length (in.)
WM182	13 x 13	7
WM183	12 x 16	7



WM193 -WM198

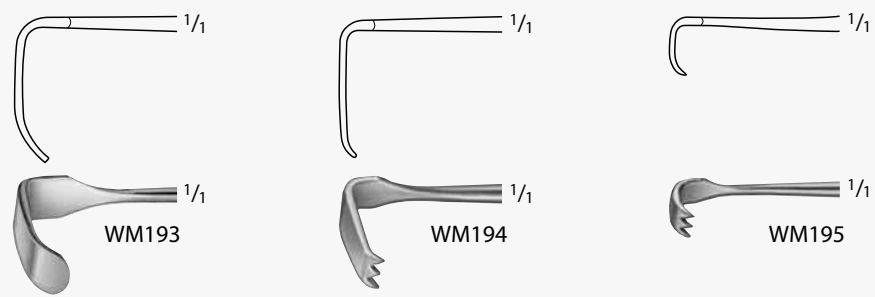

WM193

WM194

WM195



WM196

WM197

WM198

MEYERDING Thumb Retractor

Catalog Number	Blade Size	Size (#)	Blade Size (mm)	Length (in.)



WM190



WM190

CUSHING-KOCHER Retractor

Catalog Number	Blade Size (mm)	Length (in.)
WM190	10 x 10	6 7/8



WM184 -WM185



WM184



WM185

CUSHING Vein Retractor

Catalog Number	Blade Size (mm)	Length (in.)
WM184	10 x 13	8
WM185	14 x 18	8

INCHES



WM200 -WM202



WM200



WM202

CUSHING Vein Retractor  
(continued)

Catalog Number	Blade Size (mm)	Length (in.)
WM200	14 x 11	9 3/4
WM202	22 x 15	9 3/4



WM912 -WM914



WM912 -WM914

CUSHING Vein Retractor

Catalog Number	Blade Size (mm)	Length (in.)
WM912	14	12 1/2
WM913	14	14
WM914	14	16



WM766 -WM769



WM766 -WM769

GIL VERNET Retractor, Malleable

Catalog Number	Blade Size (mm)	Length (in.)
WM766	9	11 1/4
WM767	11	11 1/4
WM768	13	11 1/4
WM769	18	11 1/4





WM221

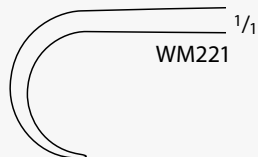

WM222 -WM230

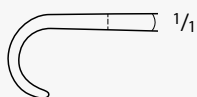

WM222



WM227



WM223



WM228



WM224



WM229



WM225



WM230

**VOLKMANN Retractor**

Catalog Number	Tip	Blade End	Blade Size (mm)	Length (in.)
WM221	SHARP	1 PRONG	8.5 x 8	8 3/4
WM222	SHARP	2 PRONGS	9 x 8	8 7/8
WM223	SHARP	3 PRONGS	9 x 13	8 7/8
WM224	SHARP	4 PRONGS	9 x 19	8 7/8
WM225	SHARP	6 PRONGS	9 x 29	8 7/8
WM227	BLUNT	2 PRONGS	8.5 x 12	8 7/8
WM228	BLUNT	3 PRONGS	8.5 x 13	8 7/8
WM229	BLUNT	4 PRONGS	8.5 x 19	8 7/8
WM230	BLUNT	6 PRONGS	8.5 x 29	8 7/8





WM240 -WM241

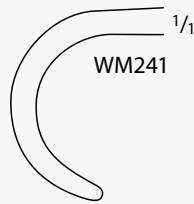
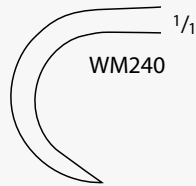

WM242 -WM265

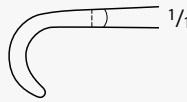
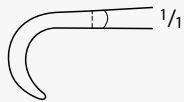
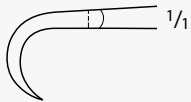

VOLKMANN Retractor, Small

Catalog Number	Tip	Blade End	Blade Size (mm)	Length (in.)
WM240	SHARP	1 PRONG	-	8 3/4
WM241	BLUNT	1 PRONG	-	8 3/4
WM242	SHARP	2 PRONGS	9 x 8	8 3/4
WM243	SHARP	3 PRONGS	9 x 13	8 3/4
WM244	SHARP	4 PRONGS	9 x 19	8 3/4
WM246	SHARP	6 PRONGS	9 x 29	8 3/4
WM248	SHARP	8 PRONGS	9 x 40	8 3/4
WM257	SEMI-S	2 PRONGS	8.5 x 8	8 3/4
WM259	SEMI-S	3 PRONGS	8.5 x 13	8 3/4
WM260	SEMI-S	4 PRONGS	8.5 x 19	8 3/4
WM261	SEMI-S	6 PRONGS	8.5 x 29	8 3/4
WM265	SEMI-S	8 PRONGS	8.5 x 40	8 3/4
WM252	BLUNT	2 PRONGS	8 x 8	8 3/4
WM253	BLUNT	3 PRONGS	8 x 13	8 3/4
WM254	BLUNT	4 PRONGS	8 x 19	8 3/4
WM256	BLUNT	6 PRONGS	8 x 29	8 3/4
WM258	BLUNT	8 PRONGS	8 x 40	8 3/4



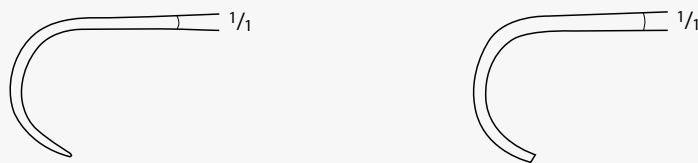

VOLKMANN Retractor, US Version

Catalog Number	Tip	Blade End	Blade Size (mm)	Length (in.)
WM260	SHARP	2 PRONGS	20 x 11	8 3/4
WM261	SHARP	3 PRONGS	20 x 18	8 3/4
WM262	SHARP	4 PRONGS	20 x 26	8 3/4
WM264	SHARP	6 PRONGS	20 x 40	8 3/4
WM265	BLUNT	2 PRONGS	20 x 11	8 3/4
WM266	BLUNT	3 PRONGS	20 x 18	8 3/4
WM267	BLUNT	4 PRONGS	20 x 26	8 3/4
WM269	BLUNT	6 PRONGS	20 x 40	8 3/4



WM262 -WM276

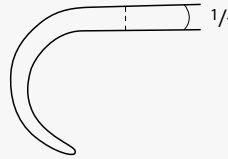
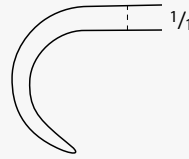

WM262



WM272



WM263



WM273



WM264



WM274



WM266



WM276

**KOCHER Retractor, Large**

Catalog Number	Tip	Blade End	Blade Size (mm)	Length (in.)
WM262	SEMI-S	2 PRONGS	16 x 9	8 3/4
WM263	SEMI-S	3 PRONGS	16 x 14	8 3/4
WM264	SEMI-S	4 PRONGS	16 x 20	8 3/4
WM266	SEMI-S	6 PRONGS	16 x 30	8 3/4
WM272	BLUNT	2 PRONGS	15.5 x 9	8 3/4
WM273	BLUNT	3 PRONGS	15.5 x 14	8 3/4
WM274	BLUNT	4 PRONGS	15.5 x 20	8 3/4
WM276	BLUNT	6 PRONGS	15.5 x 30	8 3/4



WM278 -WM279

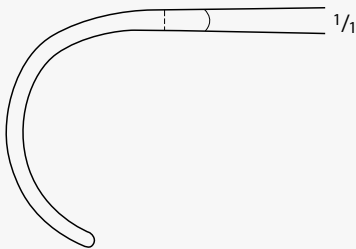

WM279



WM278

**KOERTE Retractor**

Catalog Number	Tip	Blade End	Blade Size (mm)	Length (in.)
WM279	SEMI-S	8 PRONGS	26 x 40	9 1/2
WM278	BLUNT	8 PRONGS	26 x 40	9 1/2

INCHES





WM284 -WM287

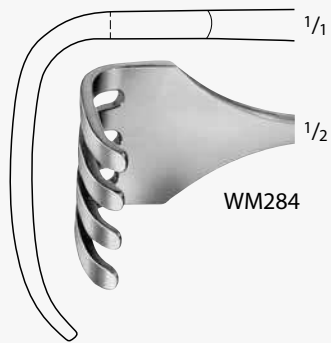

WM284

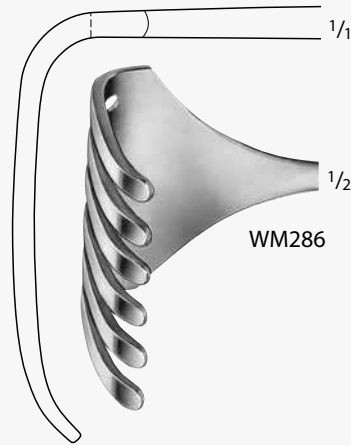

WM286

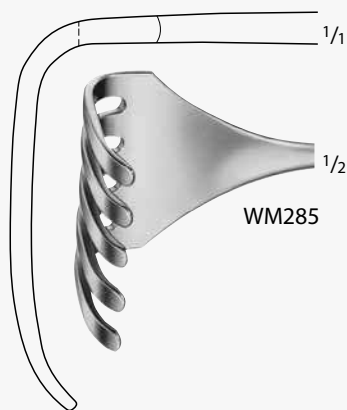

WM285

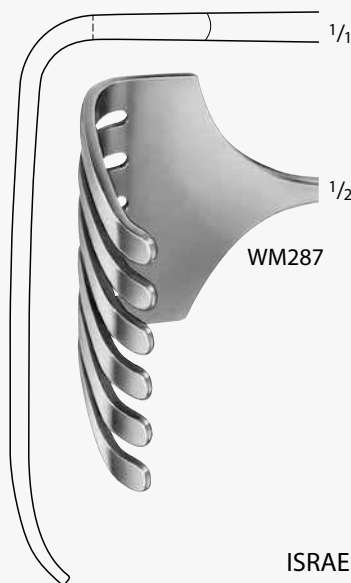

WM287



ISRAEL Retractor

Catalog Number	Tip	Blade End	Blade Size (mm)	Length (in.)
WM284	BLUNT	4 PRONGS	39 x 40	10
WM285	BLUNT	5 PRONGS	47 x 51	10
WM286	BLUNT	6 PRONGS	53 x 62	10
WM287	BLUNT	6 PRONGS	70 x 70	10

INCHES



WM284



WM284

ISRAEL Retractor, T-Handle

Catalog Number	Tip	Blade End	Blade Size (mm)	Length (in.)
WM284	BLUNT	4 PRONGS	46 x 40	7 1/2



WM293 -WM296



WM293



WM296



WM294

MURPHY Retractor

Catalog Number	Tip	Blade End	Length (in.)
WM293	SHARP	3 PRONGS	7 3/4
WM294	SHARP	4 PRONGS	7 3/4
WM296	BLUNT	4 PRONGS	7 3/4



WM290

WM290

KOERTE-WAGNER Retractor

Catalog Number	Tip	Blade End	Blade Size (mm)	Length (in.)
WM290	SEMI-S	8 PRONGS	28 x 40	11



WM311 -WM316

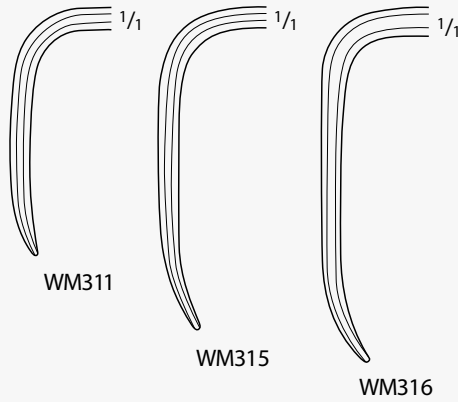

LANGENBECK Retractor

Catalog Number	Blade Size (mm)	Length (in.)
WM311	30 x 10	9
WM315	40 x 10	9
WM316	43 x 13	9



WM351 -WM353

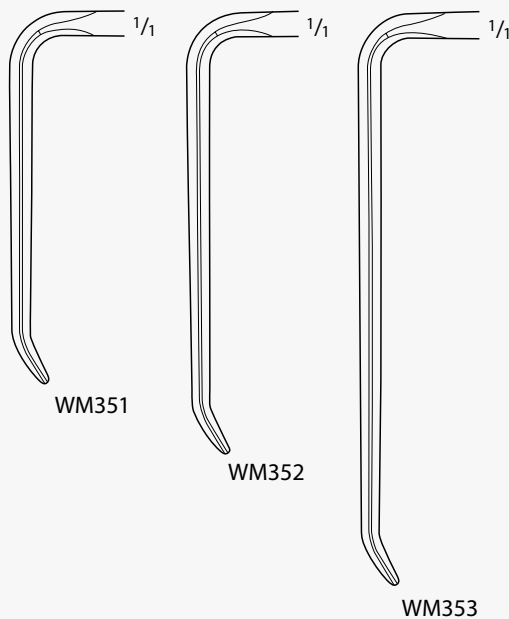

SAUERBRUCH Retractor

Catalog Number	Blade Size (mm)	Length (in.)
WM351	46 x 16	8 7/8
WM352	55 x 22	8 7/8
WM353	72 x 19	8 7/8



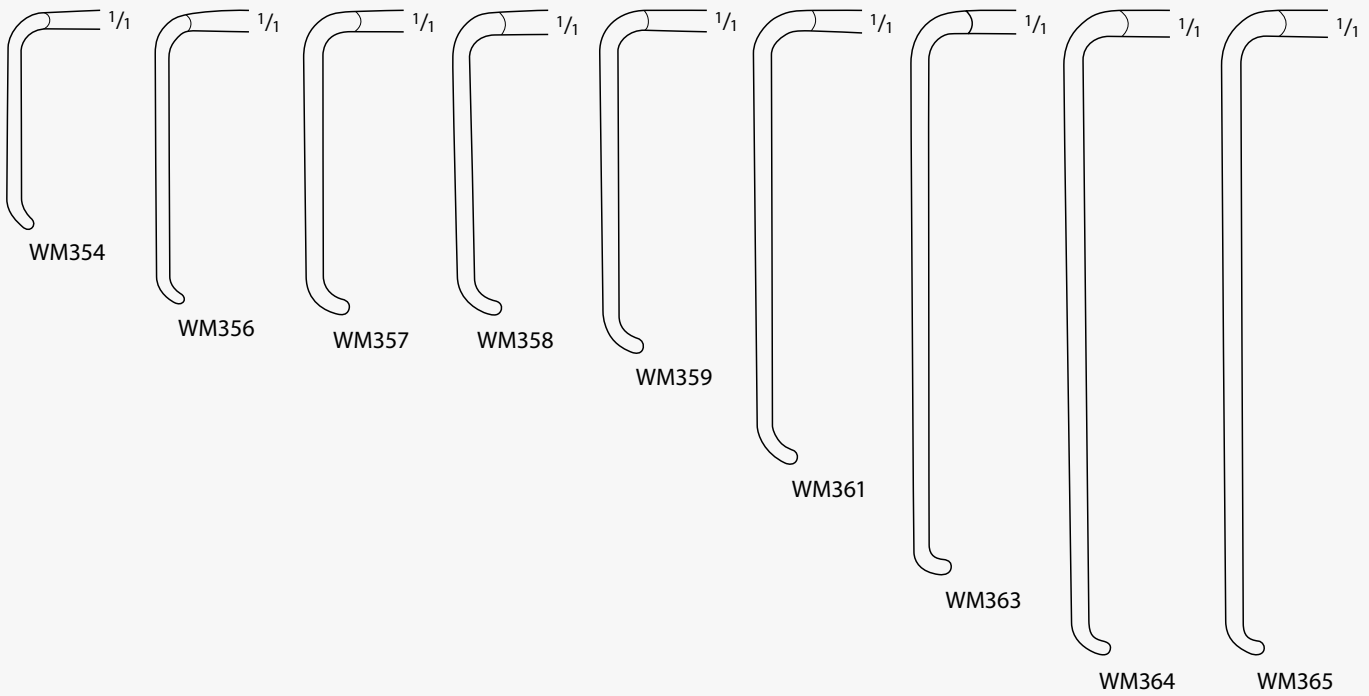

WM354 -WM365

**KOCHER-LANGENBECK Retractor**

Catalog Number	Blade Size (mm)	Length (in.)
WM354	25 x 6	8 1/2
WM356	35 x 8	8 1/2
WM357	35 x 11	8 1/2
WM358	35 x 15	8 1/2
WM359	41 x 11	8 1/2
WM361	55 x 11	8 1/2
WM363	70 x 14	8 1/2
WM364	80 x 12	8 1/2
WM365	80 x 16	8 1/2



WM785



WM785

**LAHEY Goiter Retractor**

Catalog Number	Blade Size (mm)	Length (in.)
WM785	24 x 8	77/8

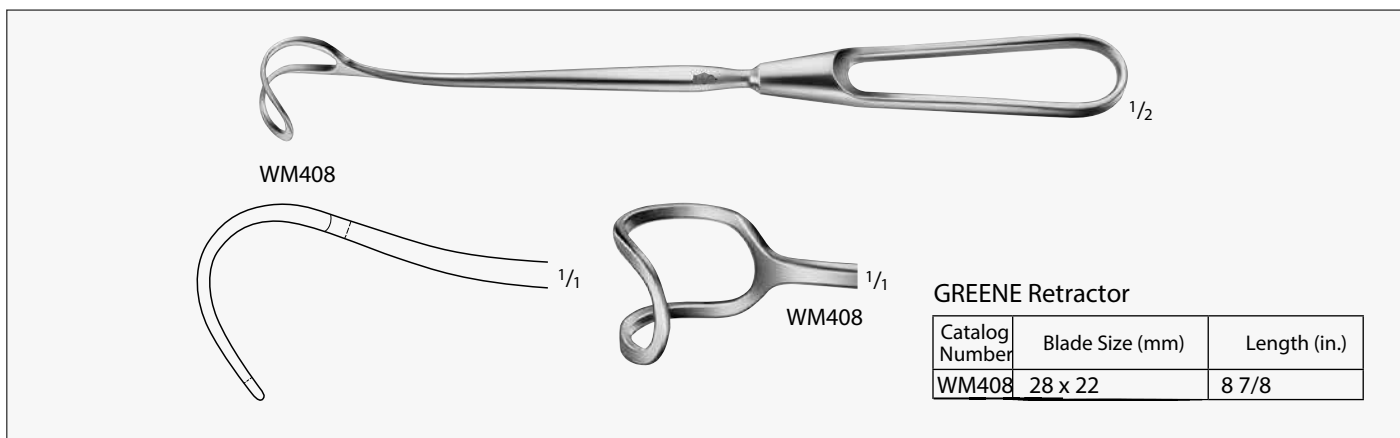
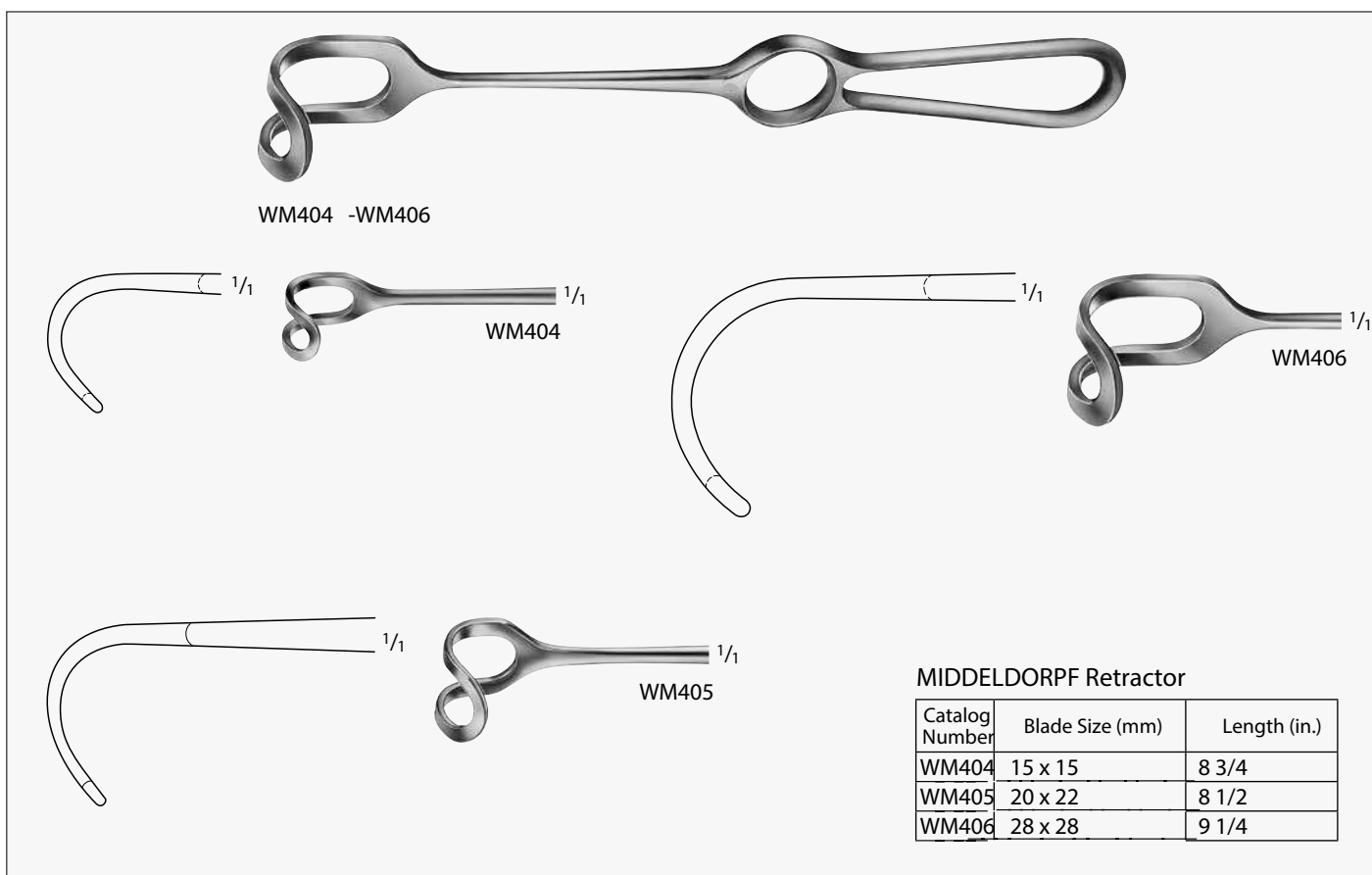
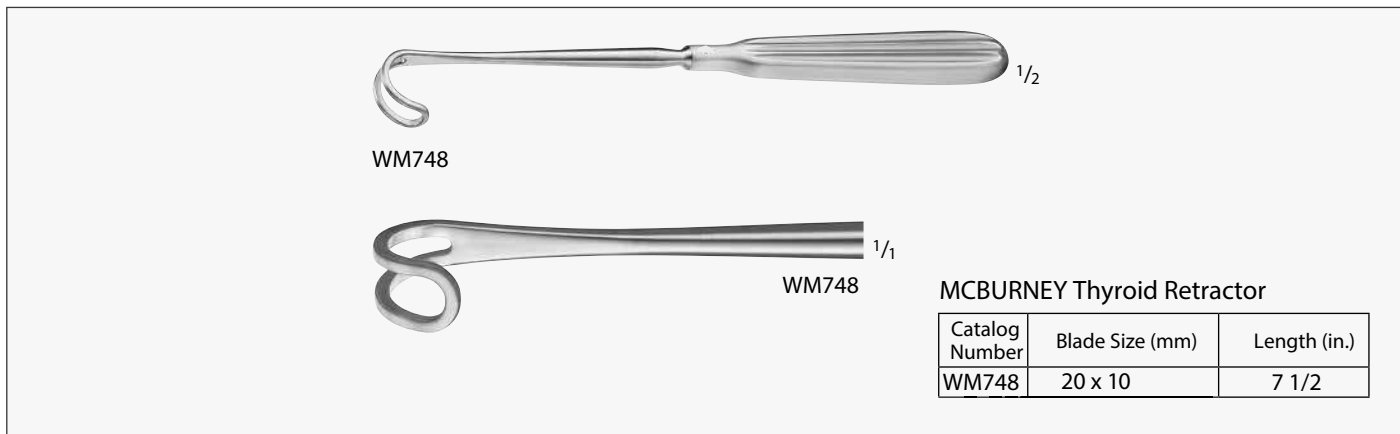



WM438 -WM439

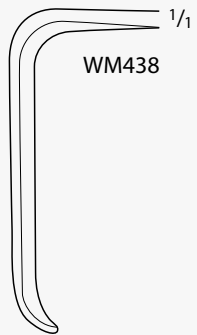

WM438

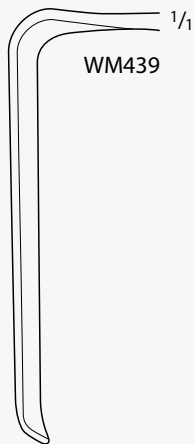

WM439



**DOCKHORN Cheek Retractor**

Catalog Number	Blade Size (mm)	Length (in.)
WM438	40 x 12	8 1/4
WM439	55 x 14	8 1/4

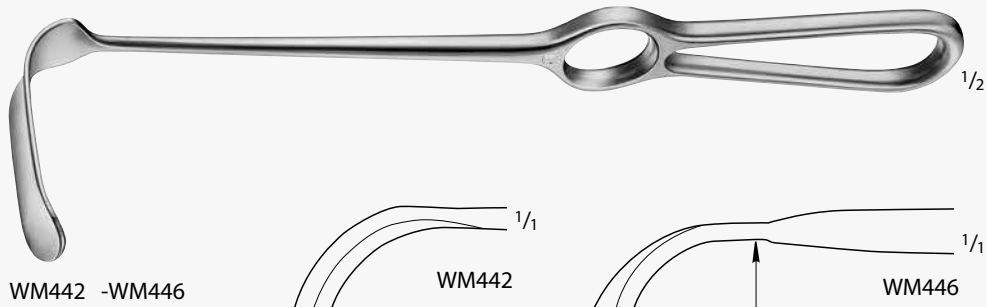

WM442 -WM446

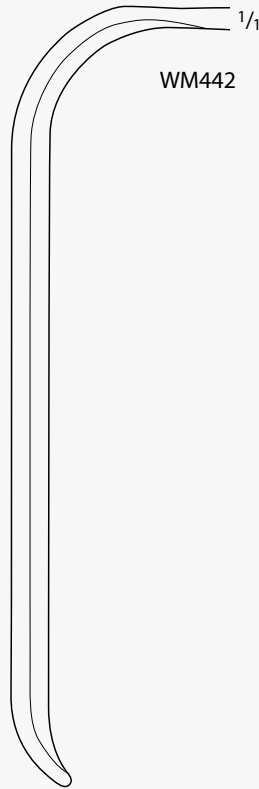

WM442

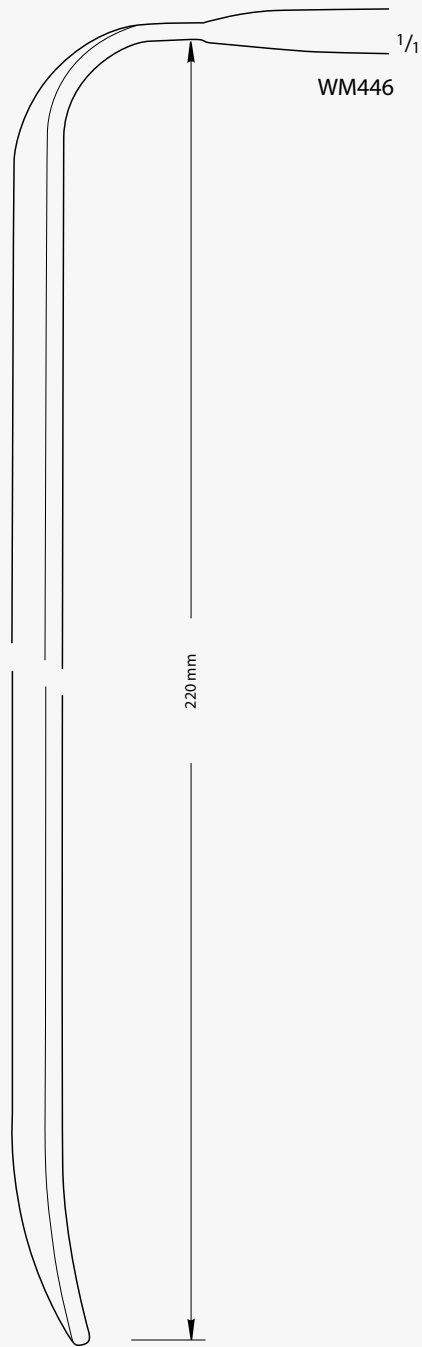

WM446

HOESEL Retractor

Catalog Number	Blade Size (mm)	Length (in.)
WM442	100 x 30	9 3/4
WM446	220 x 40	9 3/4





WM461 -WM463

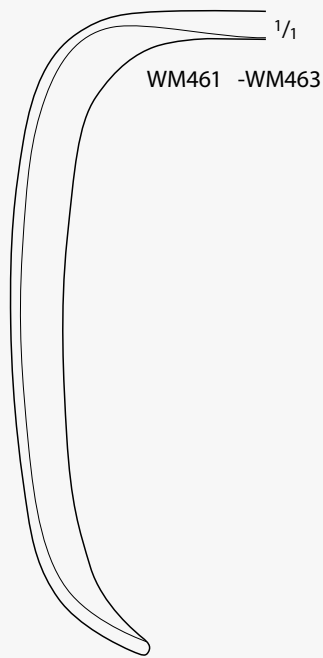

WM461 -WM463



KOCHER Retractor

Catalog Number	Blade Size (mm)	Length (in.)
WM461	80 x 42	9 3/4
WM462	80 x 50	9 3/4
WM463	80 x 60	9 3/4



WM464



WM464

KRAEMER Retractor

Catalog Number	Blade Size (mm)	Length (in.)
WM464	66 x 10	8 1/4



WM465

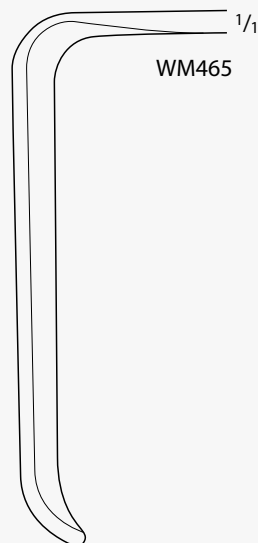

WM465

CASPAR Retractor

Catalog Number	Blade Size (mm)	Length (in.)
WM465	67 x 17	8 1/4





WM450 -WM469

**MIASPAS<sup>®</sup> Mini ALIF LANGENBECK Retractor**

Catalog Number	Blade Size (mm)	Length (in.)
WM450	125 x 20	8 1/4
WM451	125 x 35	8 1/4
WM466	80 x 20	8 1/4
WM467	110 x 20	8 1/4
WM468	80 x 35	8 1/4
WM469	110 x 35	8 1/4

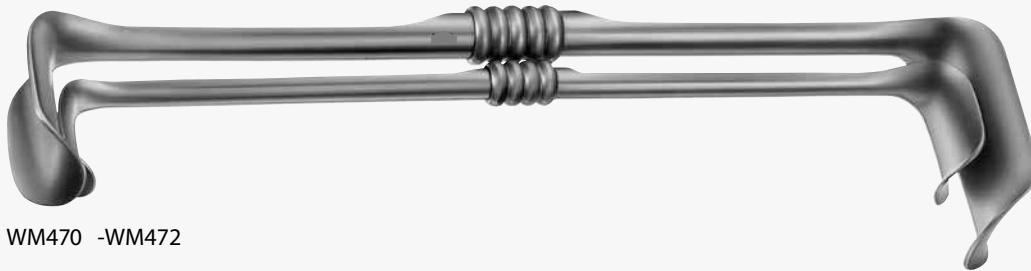

WM470 -WM472

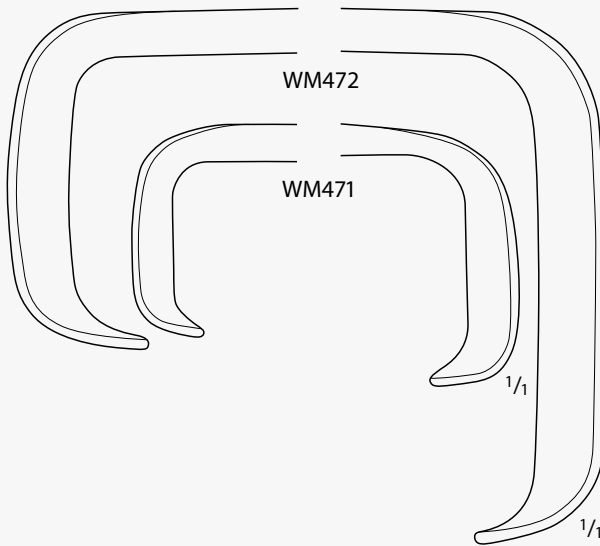

**RICHARDSON-EASTMAN Retractor**

Catalog Number	Description	Tip	Length (in.)
WM470	2/SET (WM471,WM472)	-	-



WM475 -WM477



WM475

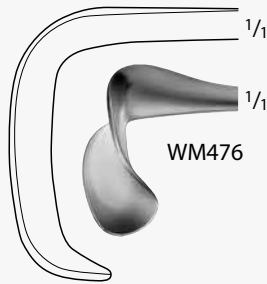

WM476

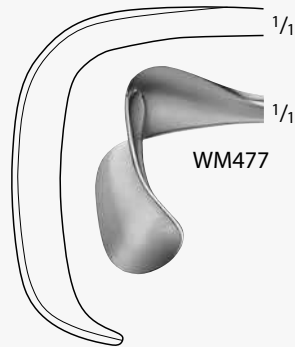

WM477



WM478

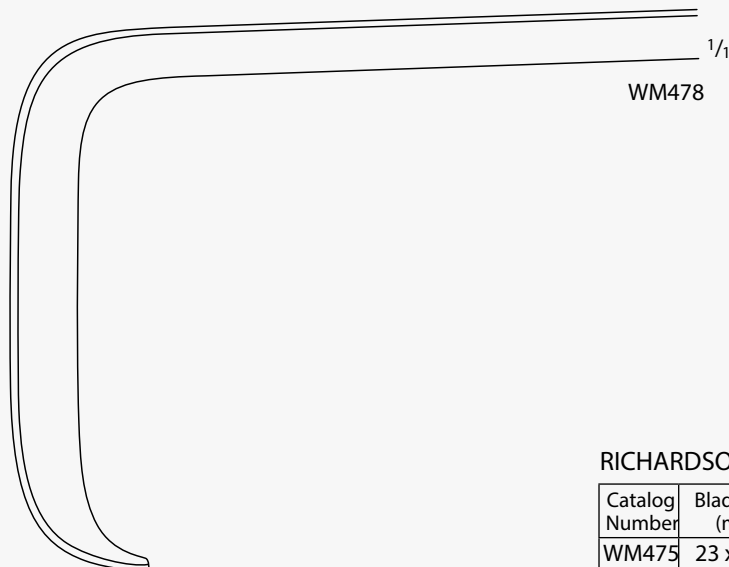

WM478

**RICHARDSON Retractor**

Catalog Number	Blade Size (mm)	Blade Size (in.)	Length (in.)
WM475	23 x 20	1 x 3/4	9 1/2
WM476	30 x 29	1 1/4 x 1 1/8	9 1/2
WM477	37 x 37	1 1/2 x 1 1/2	9 1/2
WM478	47 x 21	2 x 3/4	9 1/2





WM479



WM479



RICHARDSON Retractor

Catalog Number	Blade Size (mm)	Blade Size (in.)	Length (in.)
WM479	65 x 41	2 1/2 x 1 5/8	9 3/4

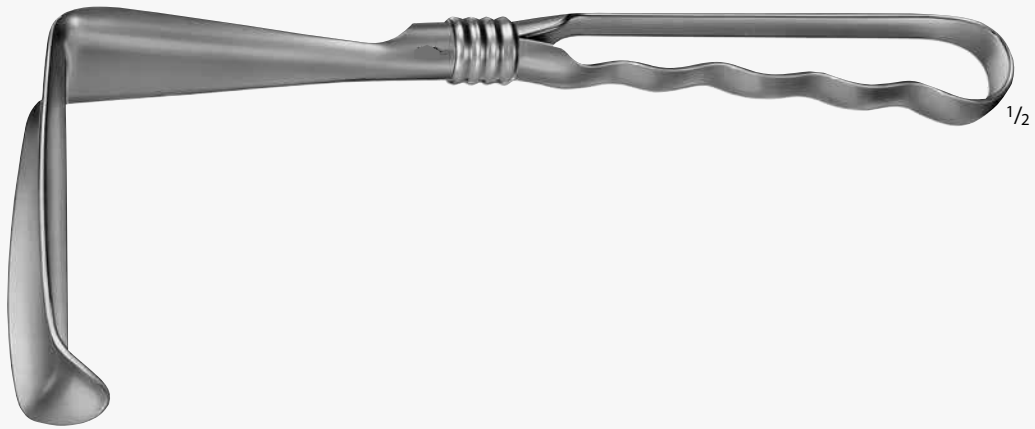

WM481 -WM484



WM481

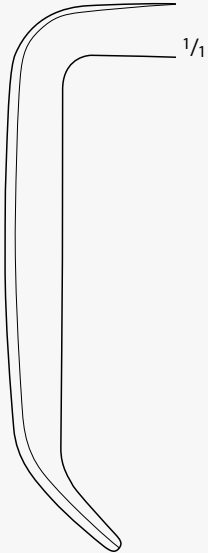

WM482

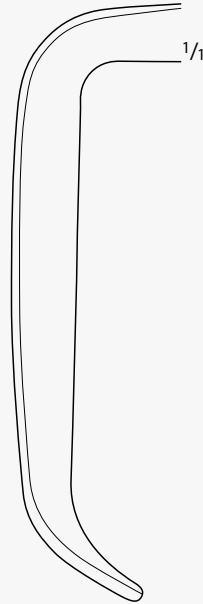

WM483

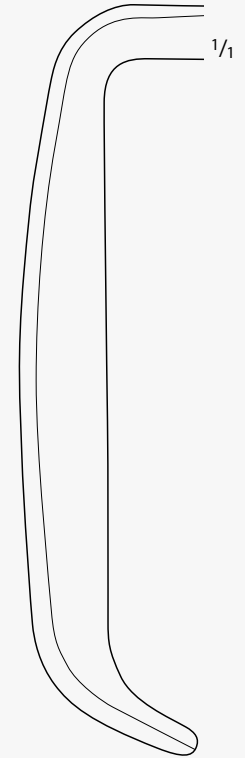

WM484

**KELLY Retractor**

Catalog Number	Blade Size (mm)	Blade Size (in.)	Length (in.)
WM481	50 x 40	2 x 1 1/2	10 1/4
WM482	64 x 54	2 1/2 x 2	10 1/4
WM483	70 x 65	2 3/4 x 2 1/2	10 1/4
WM484	90 x 76	3 1/2 x 3	10 1/4



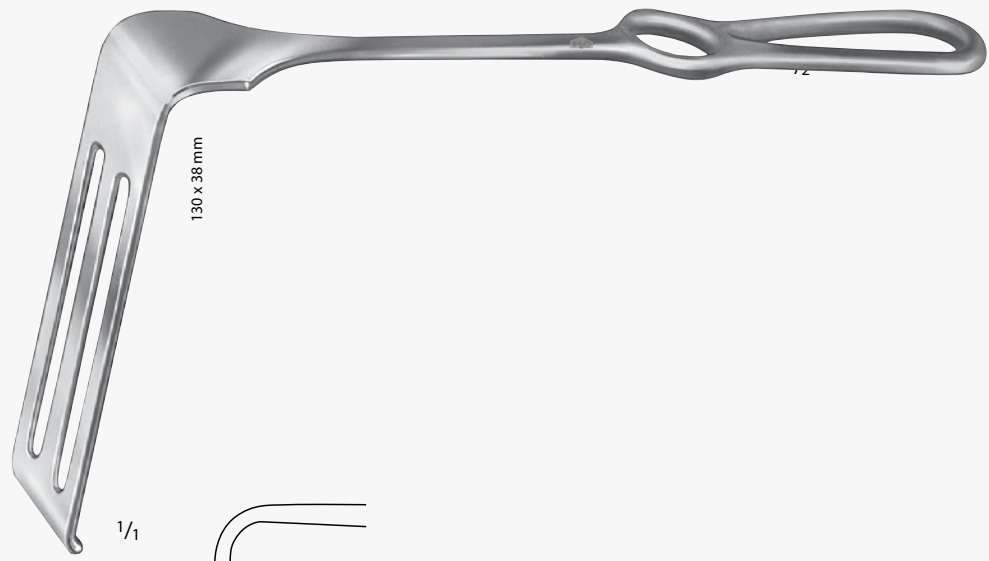

WM514

130 x 38 mm

1/1

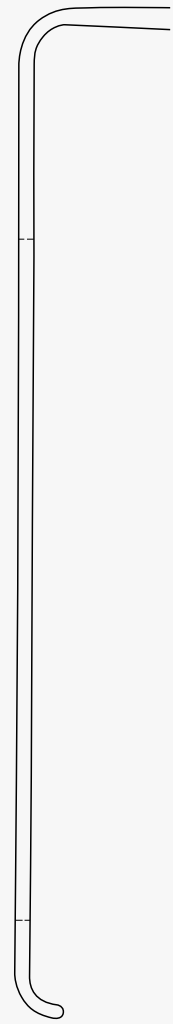

WM514



SAUERBRUCH Retractor, Open

Catalog Number	Blade Size (mm)	Length (in.)
WM514	130 x 38	10 1/4



WM551 , WM552 , WM930



WM551

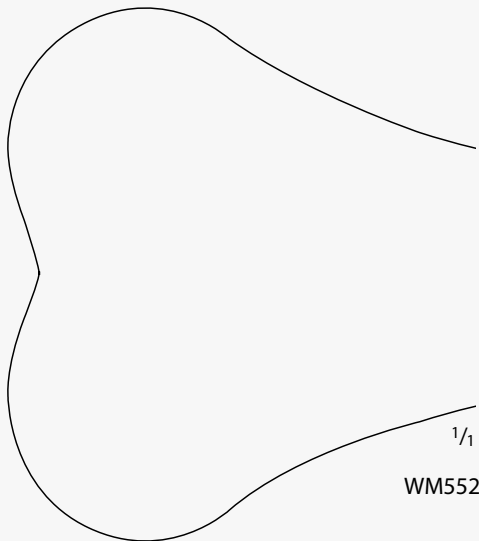

WM552

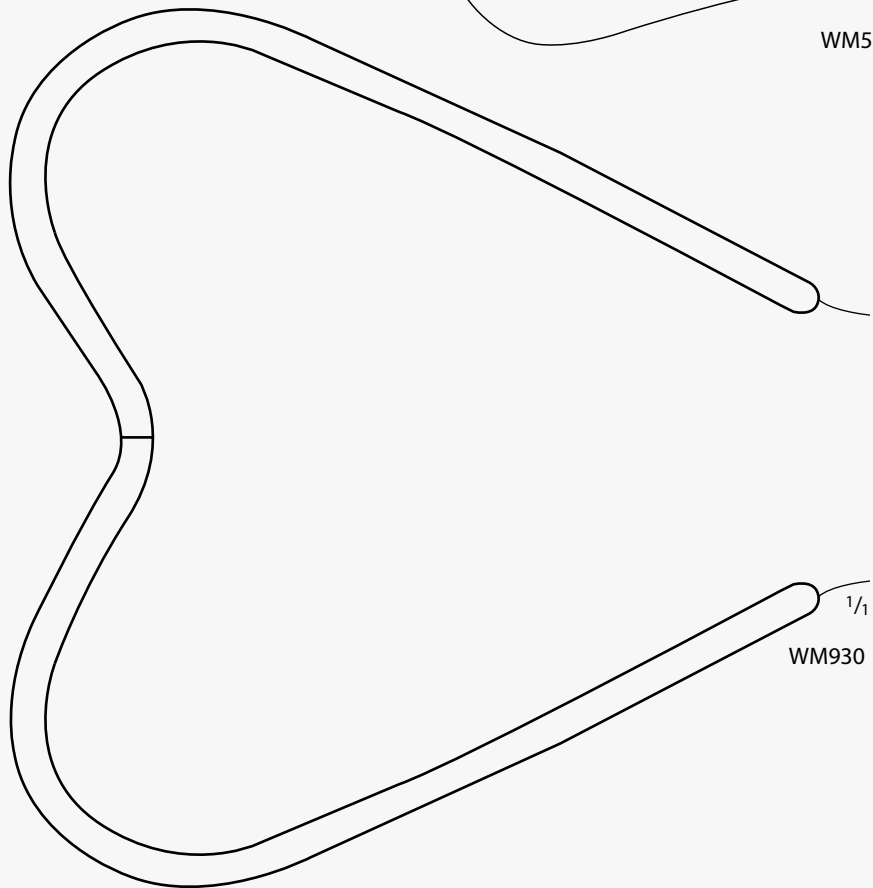

WM930



HARRINGTON Lung Spatula

Catalog Number	Blade Size (mm)	Blade End	Length (in.)
WM551	123 x 45	FLEX	11 5/8
WM552	123 x 64	FLEX	11 5/8
WM930	190 x 115	FLEX	12 1/2



WM472

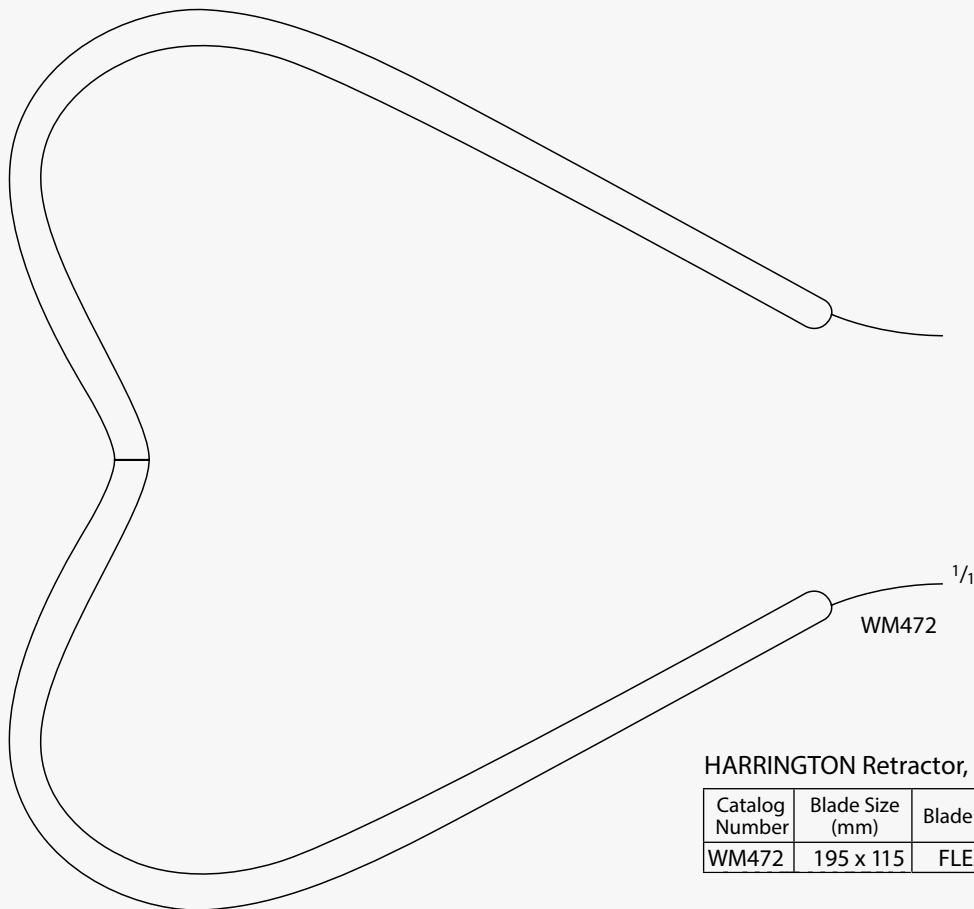

HARRINGTON Retractor, Large Blade

Catalog Number	Blade Size (mm)	Blade End	Length (in.)
WM472	195 x 115	FLEX	14 3/8





WM553

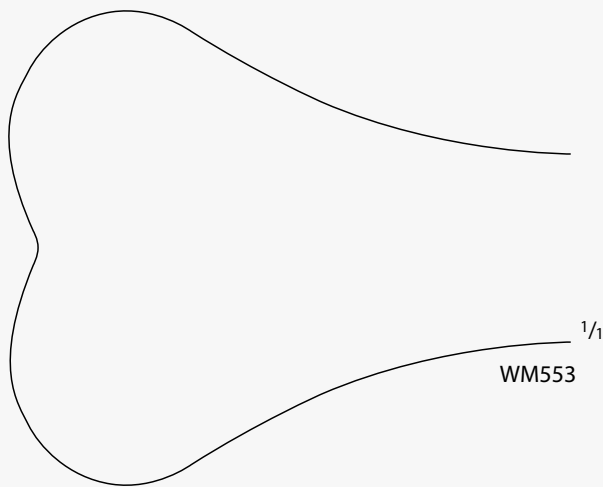

WM553

HARRINGTON-PEMBERTON Lung  
Spatula

Catalog Number	Blade Size (mm)	Blade End	Length (in.)
WM553	175 x 64	FLEX	11 5/8



WM594 -WM597

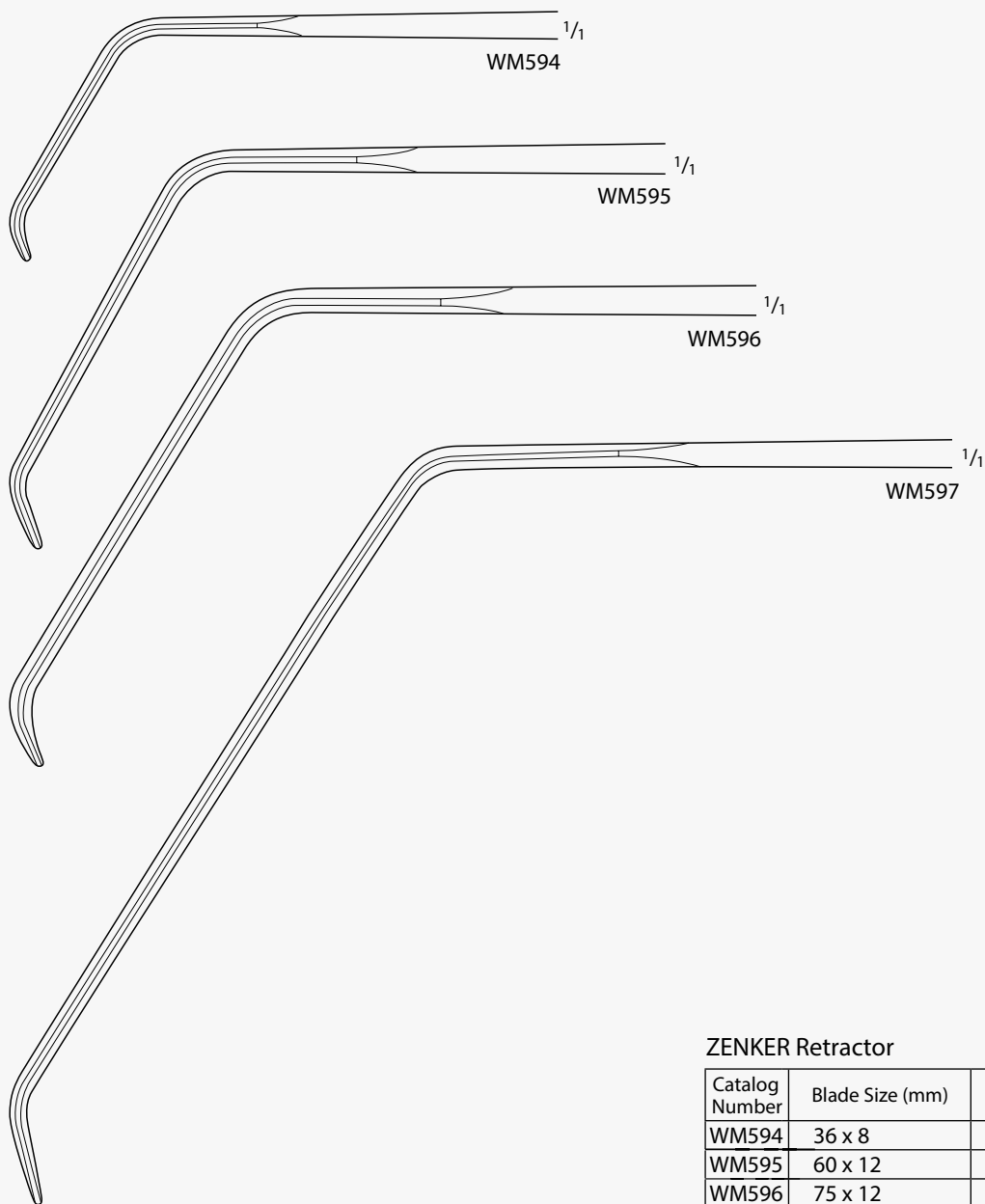

ZENKER Retractor

Catalog Number	Blade Size (mm)	Length (in.)
WM594	36 x 8	9 1/2
WM595	60 x 12	10
WM596	75 x 12	10 5/8
WM597	120 x 12	11 1/2



WM600

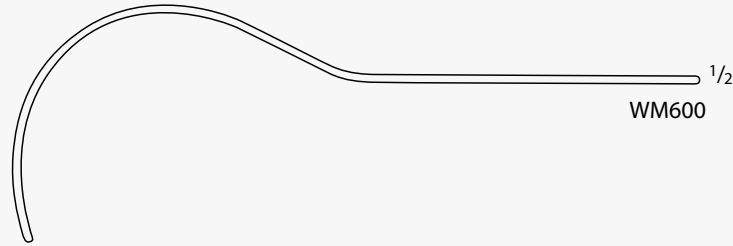

WM600

DEAVER Retractor

Catalog Number	Blade Size (mm)	Blade Size (in.)	Length (in.)
WM600	19	3/4	7



WM606



WM606

DEAVER Retractor, Double Ended

Catalog Number	Blade Size (mm)	Blade Size (in.)	Length (in.)
WM606	25	1	9 1/4





WM601

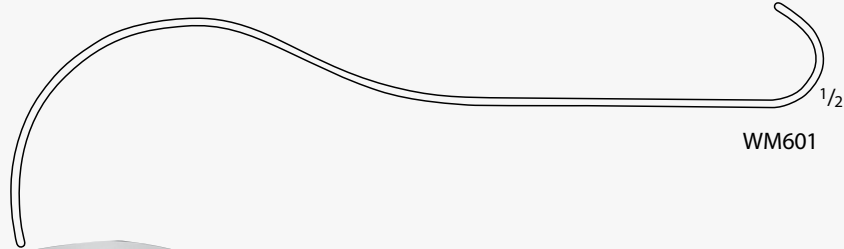

WM601



WM602 - WM603

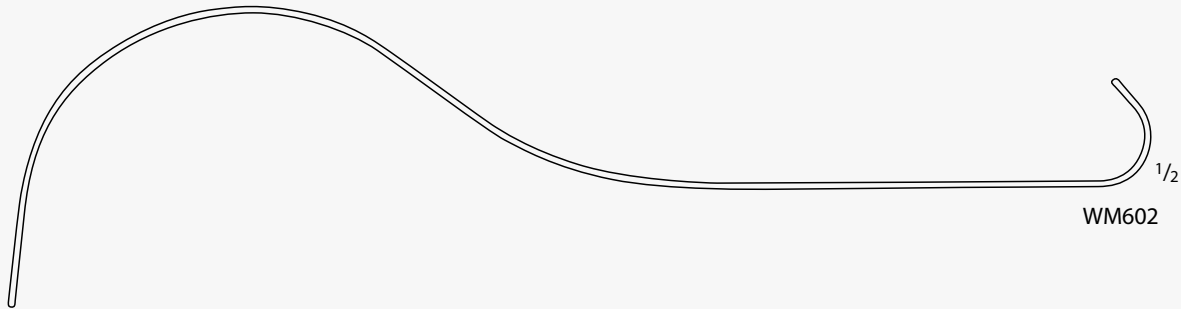

WM602

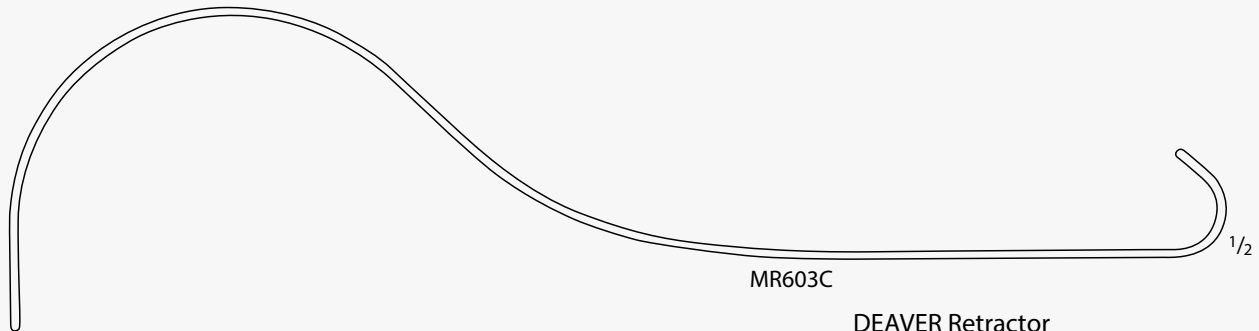

MR603C

DEAVER Retractor

Catalog Number	Blade Size (mm)	Blade Size (in.)	Length (in.)
WM601	22	7/8	8 1/2
WM602	25	1	11 3/4
WM603	25	1	12 3/8

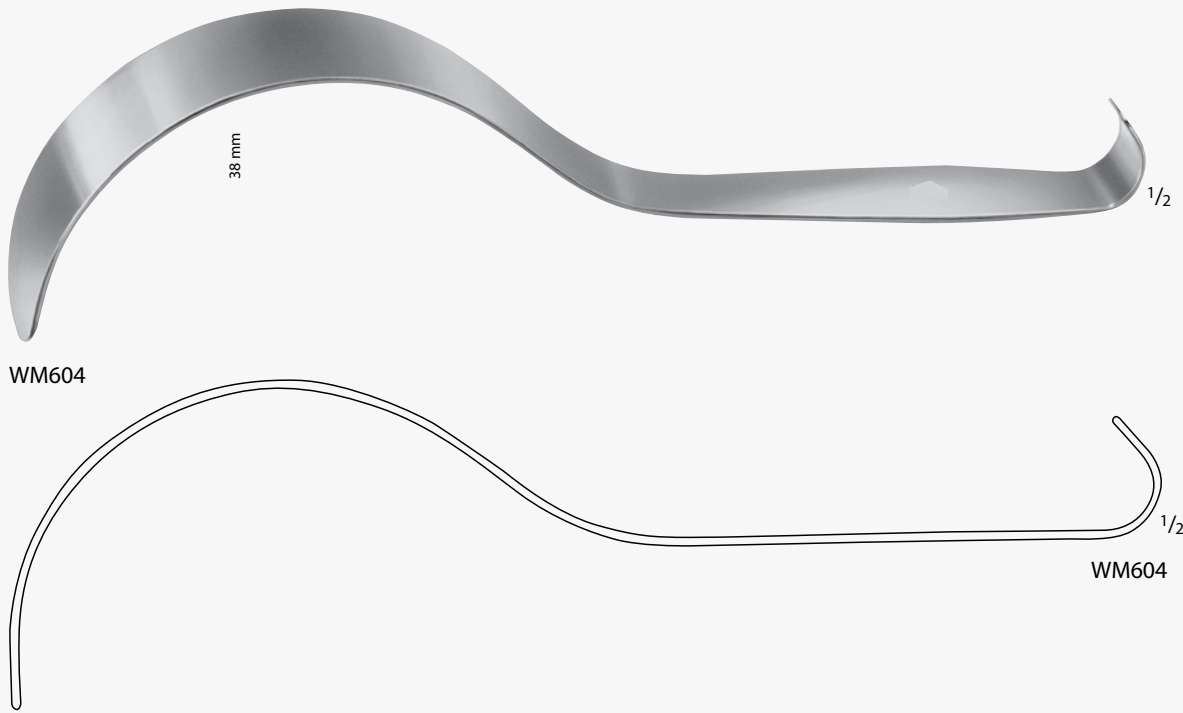

DEAVER Retractor  
(continued)

Catalog Number	Blade Size (mm)	Blade Size (in.)	Length (in.)
WM604	38	1 1/2	11 3/4



WM605 -WM607

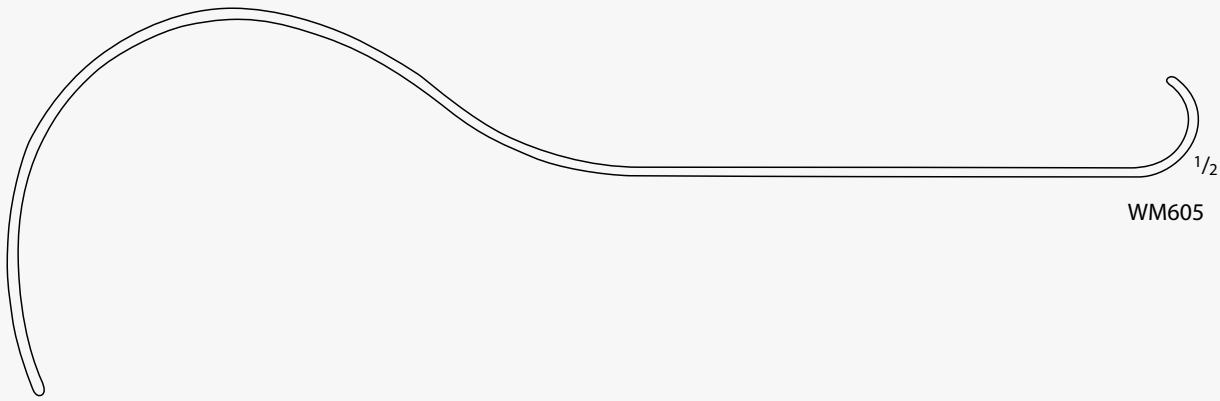

WM605

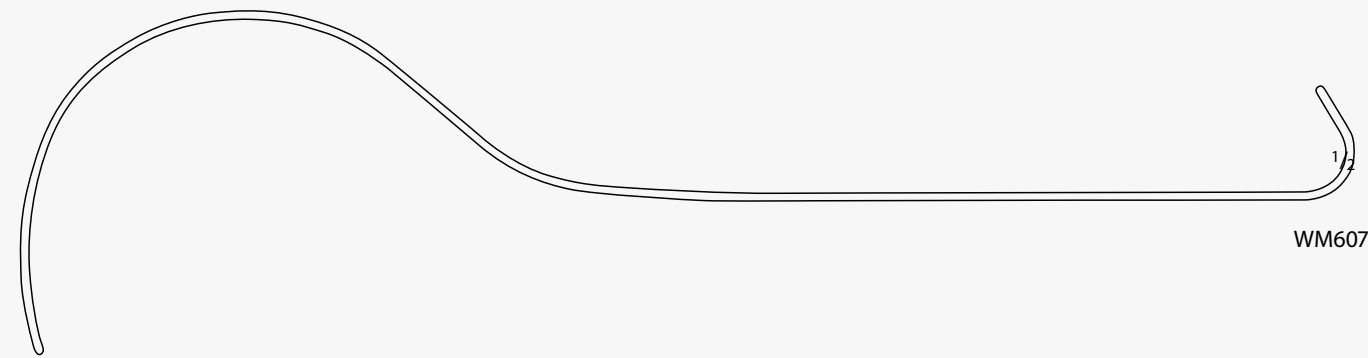

WM607

DEAVER Retractor  
(continued)

Catalog Number	Blade Size (mm)	Blade Size (in.)	Length (in.)
WM605	50	2	12 1/4
WM607	25	1	14 3/8



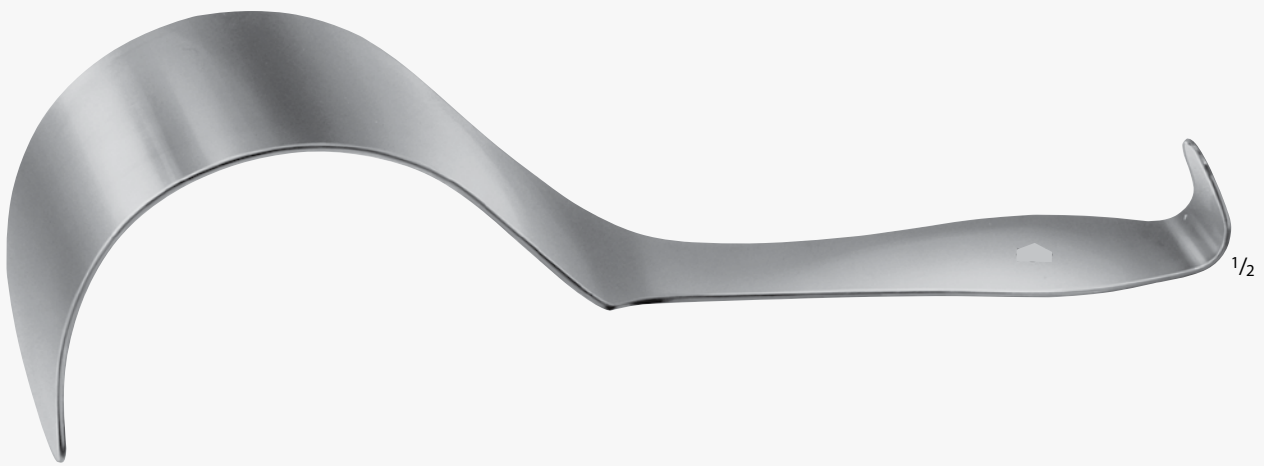

WM608

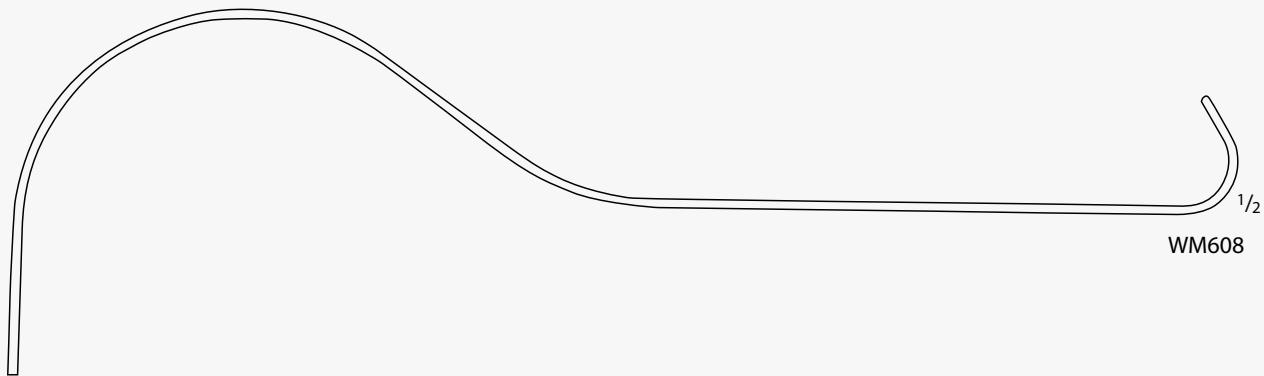

WM608

DEAVER Retractor  
(continued)

Catalog Number	Blade Size (mm)	Blade Size (in.)	Length (in.)
WM608	75	3	12 1/2



WM611 -WM615

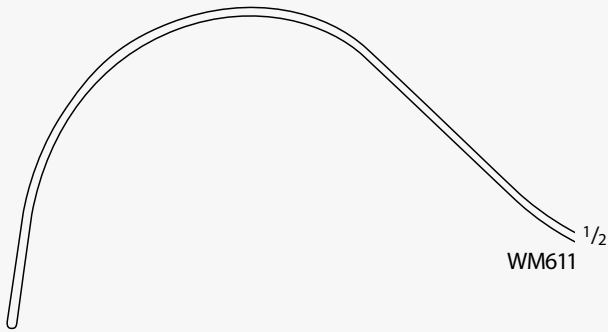

WM611 <sup>1</sup>/<sub>2</sub>

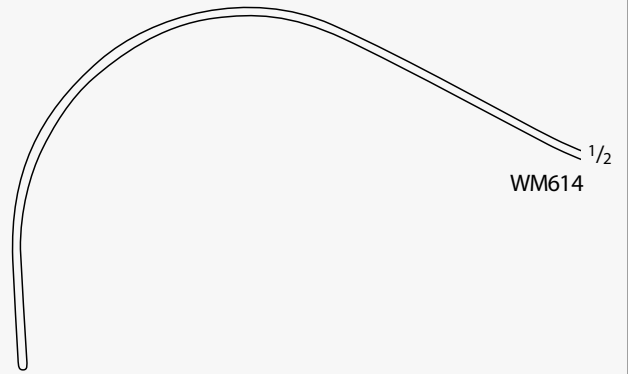

WM614 <sup>1</sup>/<sub>2</sub>

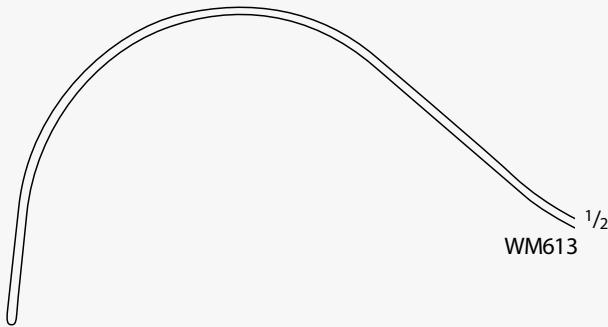

WM613 <sup>1</sup>/<sub>2</sub>

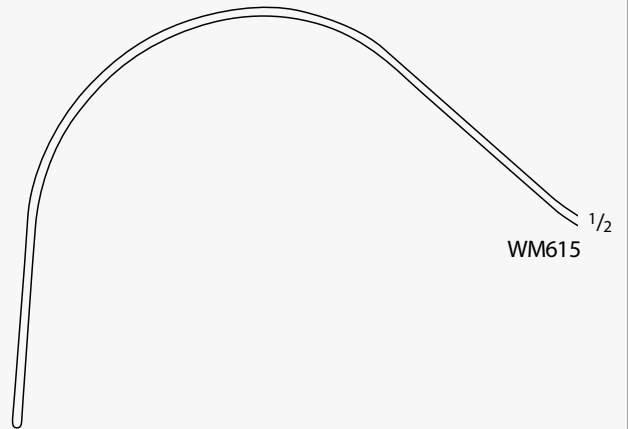

WM615 <sup>1</sup>/<sub>2</sub>



DEAVER Retractor, W/ Grip

Catalog Number	Blade Size (mm)	Blade Size (in.)	Length (in.)
WM611	25	1	12 1/4
WM613	38	1 1/2	12 1/4
WM614	50	2	12
WM615	75	3	12 1/4



WM071 -WM076

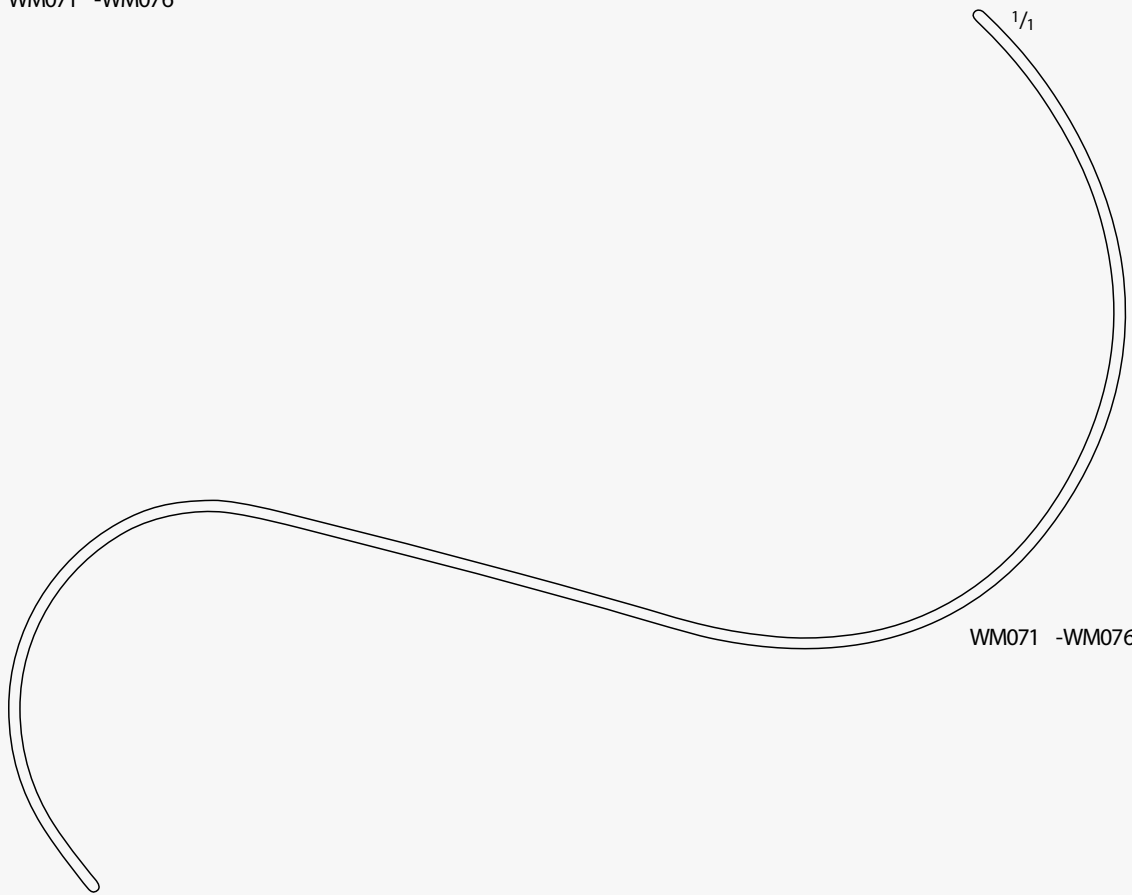

WM071 -WM076



HASSON "S" Retractor, 2/Set

Catalog Number	Blade	Blade Size (mm)	Length (in.)
WM076	MALLEABLE	10	6 1/4
WM077	MALLEABLE	13	7
WM071	RIGID	10	7 1/8
WM072	RIGID	13	7 1/8



WM750

TUFFIER Spatula, Malleable

Catalog Number	Blade Size (mm)	Blade Size (in.)	Length (in.)
WM750	17 / 25	3/4 / 1	7 7/8



WM751 -WM763 , WM498, WM480 -WM484

Ribbon Spatula, Malleable

Catalog Number	Blade Size (mm)	Blade Size (in.)	Length (in.)
WM751	12	1/2	7 7/8
WM752	17	3/4	7 7/8
WM481	25	1	8
WM755	25	1	9 3/4
WM498	75	3	13
WM482	20	3/4	13
WM756	25	1	13
WM761	30	1 1/4	13
WM762	40	1 1/2	13
WM763	50	2	13
WM483	65	2 1/2	13
WM484	100	4	13



WM758

HABERER Spatula, Malleable

Catalog Number	Blade Size (mm)	Blade Size (in.)	Length (in.)
WM758	40 / 50	1 1/2 / 2	12



WM374

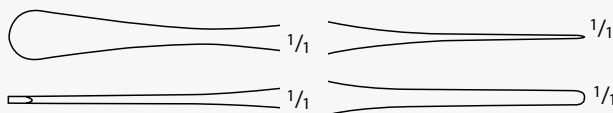

WM374

Spatula and Packer, Double Ended

Catalog Number	Length (in.)
WM374	5 3/4



WM667



WM669

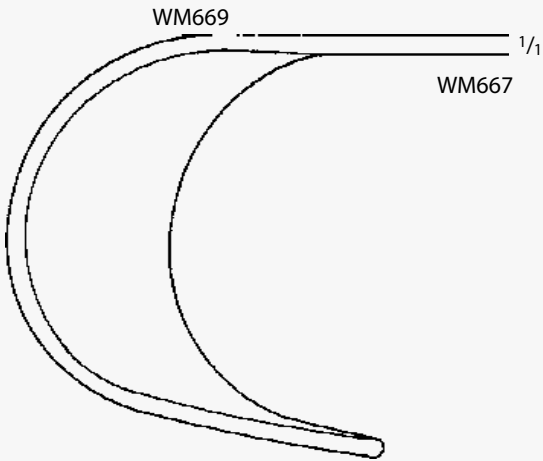

WM667

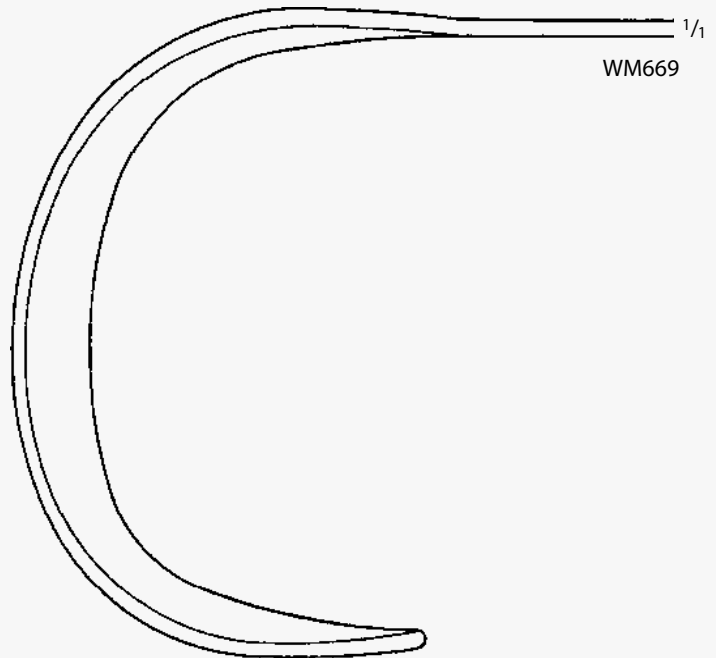

WM669



DOYEN Abdominal Retractor

Catalog Number	Blade Size (mm)	Length (in.)
WM667	53 x 80	9 3/4
WM669	72 x 82	10 1/4



WM491

1/2



WEINBERG Vagotomy Retractor, Joe's Hoe

Catalog Number	Blade Size (mm)	Length (in.)
WM491	47 x 57 / 93 x 157	9

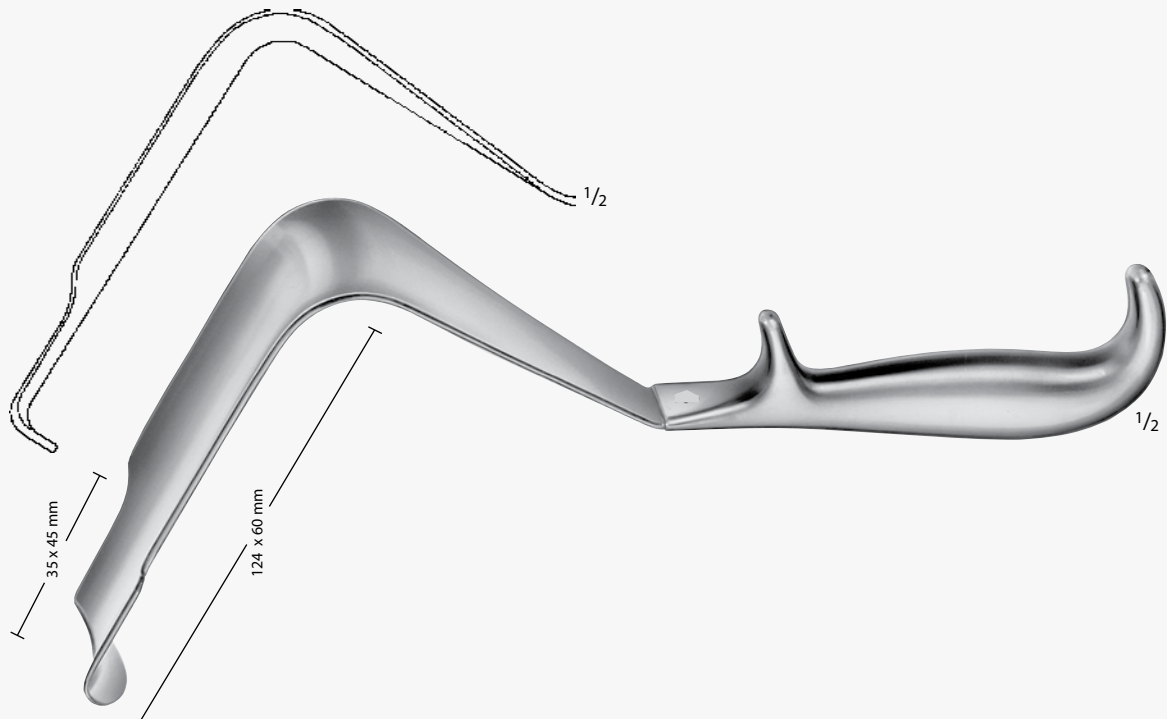

WM670

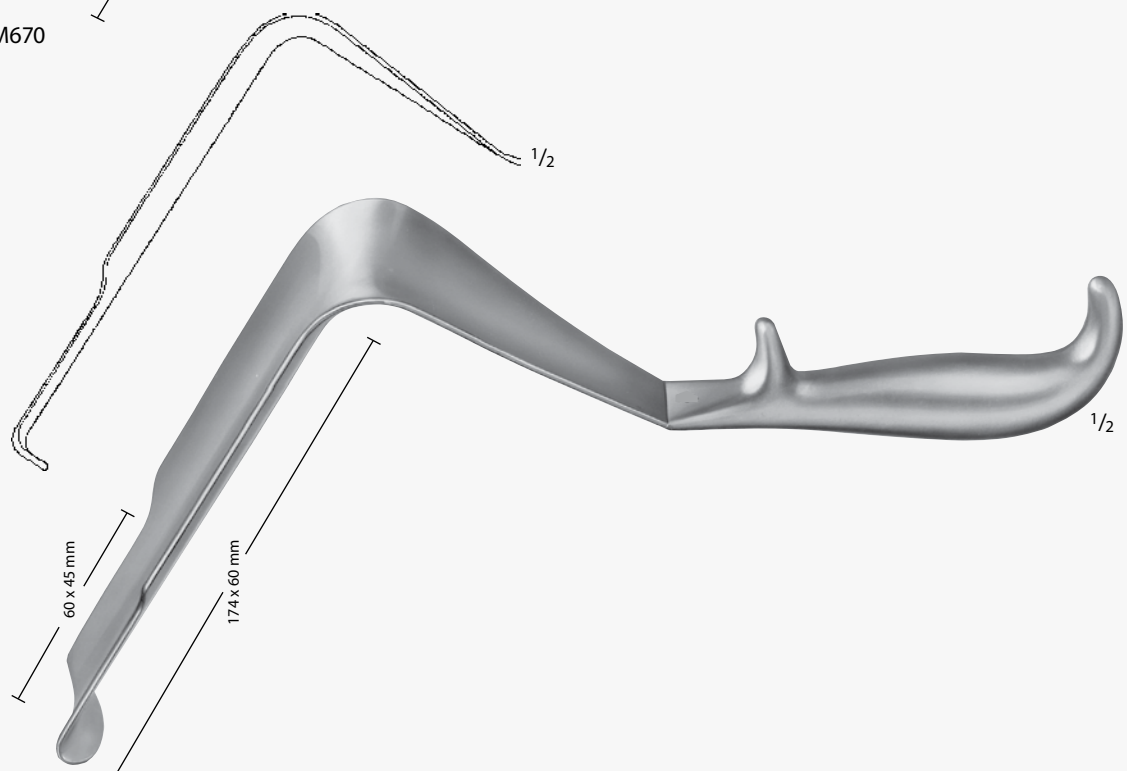

WM672



ST. MARKS Pelvis Retractor

Catalog Number	Blade Size (mm)	Length (in.)
WM670	124 x 60	11 1/2
WM672	174 x 60	13

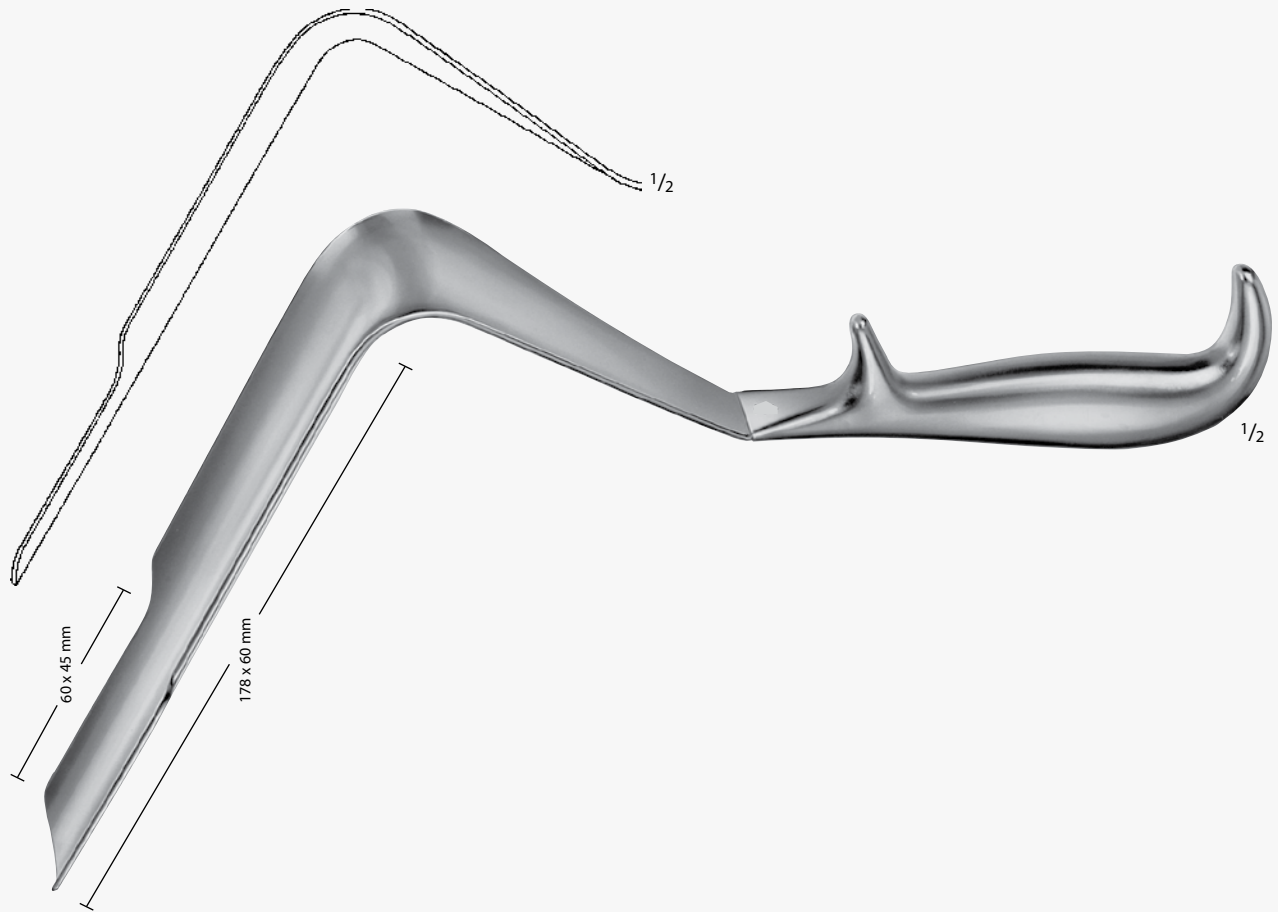

WM674

ST. MARKS Pelvis Retractor  
(continued)

Catalog Number	Blade Size (mm)	Length (in.)
WM674	178 x 60	13



WM626

MUELLER Retractor

Catalog Number	Blade Size (mm)	Length (in.)
WM626	250 x 30	10 5/8



WM129

MAYO-COLLINS Appendectomy Retractor

Catalog Number	Length (in.)
WM129	6 3/4

INCHES

1  
2  
3  
4  
5  
6  
7  
8  
9  
10  
11

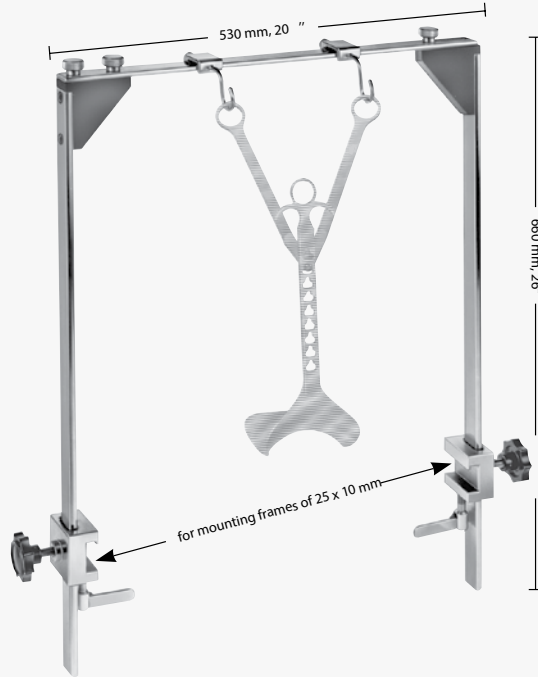

WM708 -WM709

ROCHARD Retractor Mounting Frame,  
F/ MR711C -MR715C

Catalog Number	Mounting Arms
WM708	DOUBLE
WM709	SINGLE

Mounting frame for fastening to the lateral bars of the operating tables, can be dismantled for decontamination and sterilization.

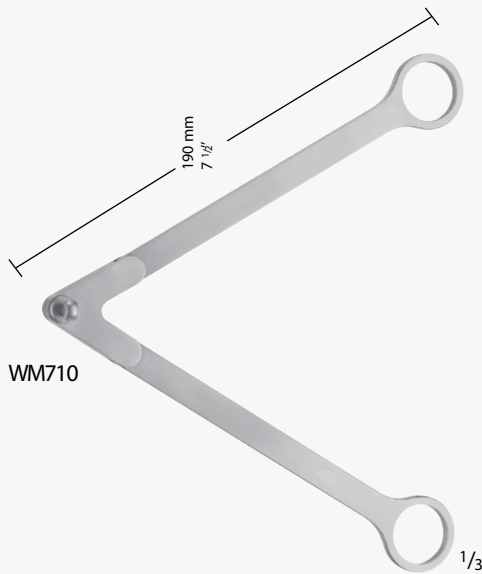

WM710

ROCHARD Fixation Device,  
F/ MR711C -MR715C

Catalog Number	Length (mm)	Length (in.)
WM710	190	7 1/2



WM711 -WM715

ROCHARD Blades

Catalog Number	Blade Size (mm)	Length (in.)
WM711	48 x 90	12 1/4
WM712	48 x 105	12 1/4
WM713	48 x 120	12 1/4
WM714	48 x 135	12 1/4
WM715	48 x 155	12 1/4

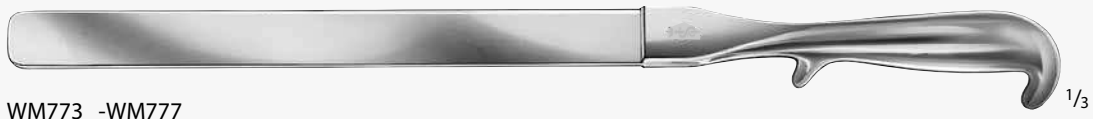

WM773 -WM777

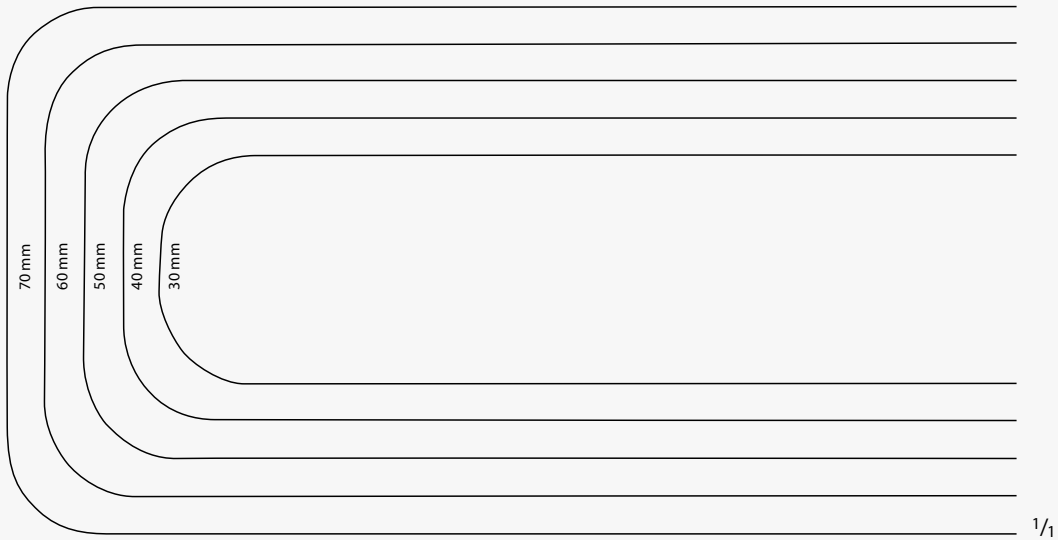

WM773 -WM777

Abdominal Retractor, Malleable,  
W/ Handle

Catalog Number	Blade Size (mm)	Blade Size (in.)	Length (in.)
WM773	30	1 1/4	16 1/8
WM774	40	1 1/2	16 1/8
WM775	50	2	16 1/8
WM776	60	2 1/2	16 1/8
WM777	70	2 3/4	16 1/8



WM226, WM582 -WM586

### Laparotomy Ring

Catalog Number	Diameter (in.)
WM582	1 1/2
WM585	1 3/4
WM226	2
WM586	3

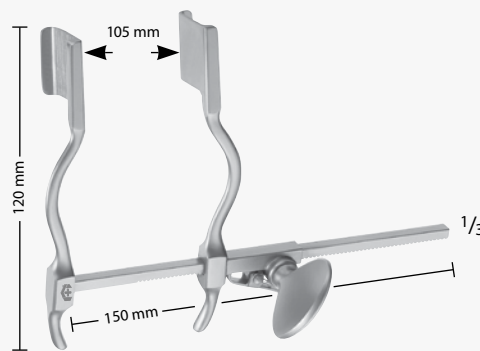

WM512

### HERTZLER Abdominal Retractor

Catalog Number	Blade Size (mm)
WM512	20 x 25

INCHES

1  
2  
3  
4  
5  
6  
7  
8  
9  
10  
11

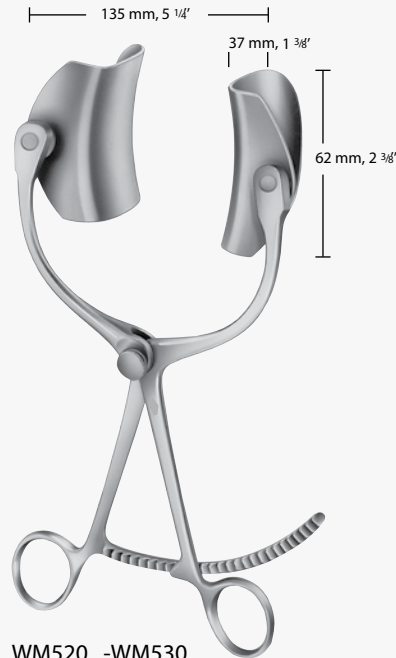

WM520 -WM530



WM551

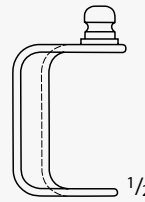

IP551C

COLLIN Abdominal Retractor W/ Ball Snap Closure

Catalog Number	Description
WM530	SET COMPLETE
WM520	SPREADER ONLY
WM551	LATERAL BLADES, Pair, 37 x 62



WM399

Blade Ejector

Catalog Number	Description	Length (in.)
WM399	FOR CHANGING BLADES WITH BALL SNAP CLOSURE	4 1/2



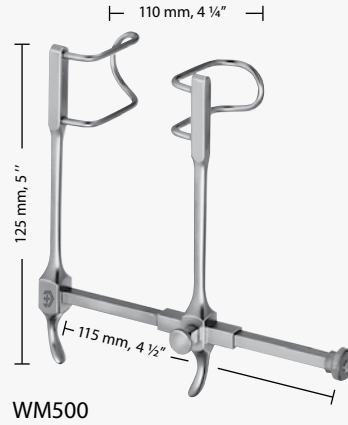

GOSSET Abdominal Retractor, Small

Catalog Number	Blade Depth (mm)
WM500	38

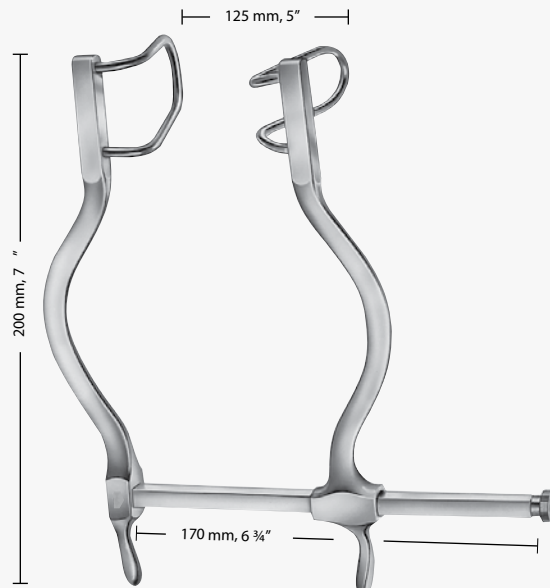

GOSSET Abdominal Retractor, Medium

Catalog Number	Blade Depth (mm)
WM502	55

INCHES



250

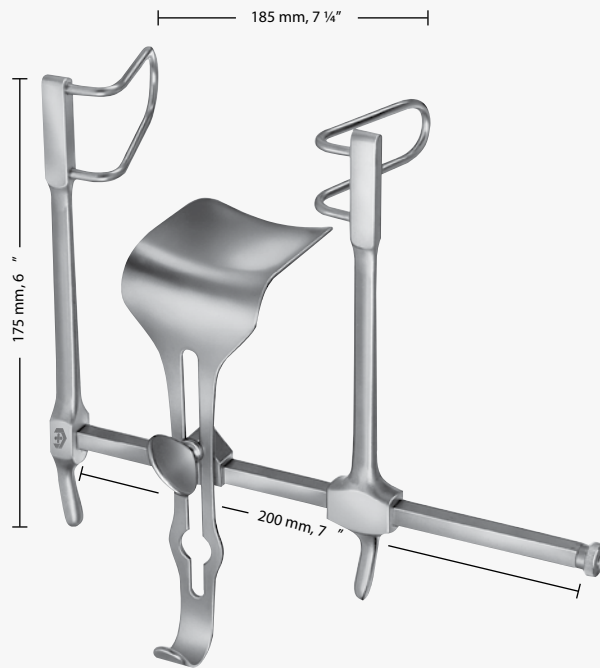

WM505 -WM506

GOSSET Abdominal Retractor, Large

Catalog Number	Description
WM505	SET COMPLETE
WM506	CENTER BLADE ONLY 59 x 57MM
WM505	Includes:
WM506	1Center Blade

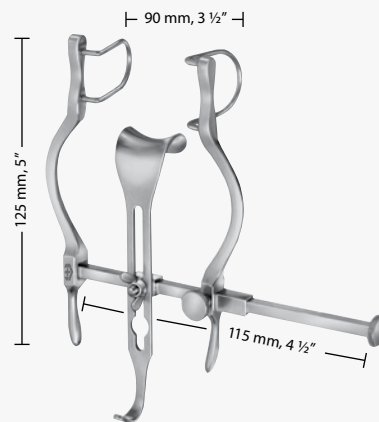

WM601 -WM602

BALFOUR Baby Abdominal Retractor

Catalog Number	Description
WM601	SET COMPLETE
WM602	CENTER BLADE ONLY, 21 x 24 MM
WM601	Includes Blade

INCHES

1  
2  
3  
4  
5  
6  
7  
8  
9  
10  
11

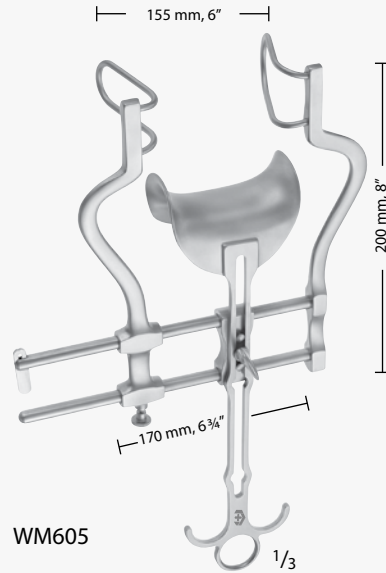

WM605

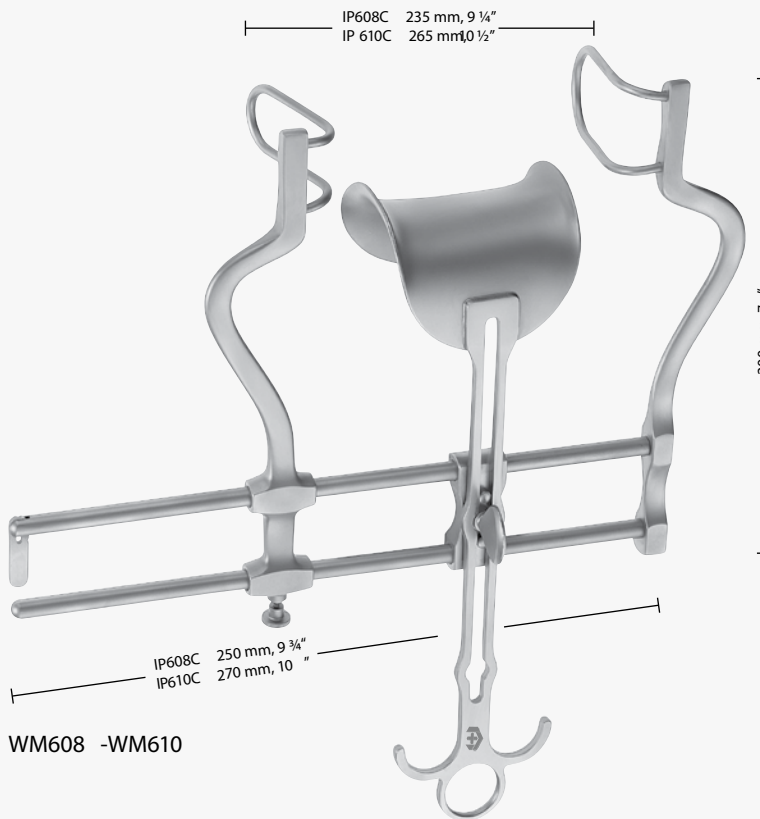

WM608 -WM610

### BALFOUR Abdominal Retractor

Catalog Number	Description	Lateral Blades Depth (mm)
WM605	BALFOUR RETRACTOR, 200 x 155 MM	60
WM608	BALFOUR RETRACTOR, 200 x 235 MM	66
WM610	BALFOUR RETRACTOR, 200 x 265 MM	90
WM606	CENTER BLADE, 47 x 80 MM	-
WM609	CENTER BLADE, 62 x 76 MM	-
WM611	CENTER BLADE, 80 x 80 MM	-

INCHES



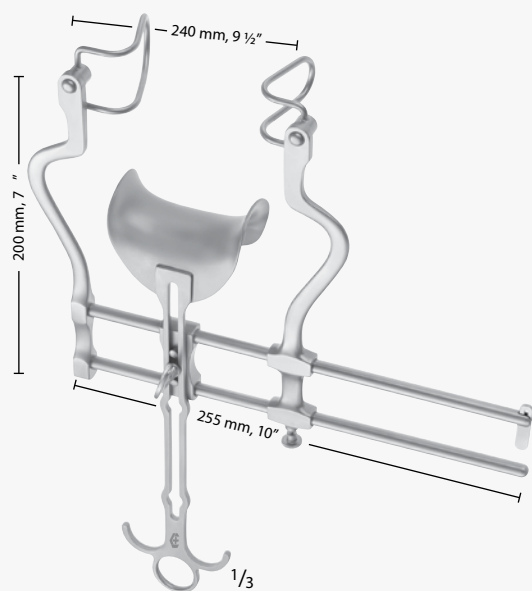
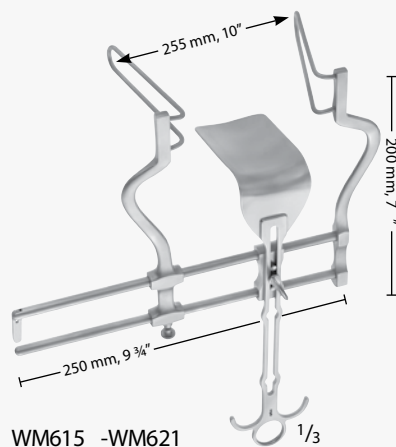

BALFOUR Abdominal Retractor  
(continued)

Catalog Number	Description
WM615	BALFOUR RETRACTOR, 200 x 255 MM COMPLETE W/ IP616C
WM632	BALFOUR RETRACTOR, COMPLETE W/ IP606C , IP621C , IP622C
WM634	BALFOUR RETRACTOR, COMPLETE W / IP609C , IP621C , IP624C
WM636	BALFOUR RETRACTOR, COMPLETE W/ IP611C , IP621C , IP626C
WM638	BALFOUR RETRACTOR, COMPLETE W/ IP611C , IP621C , IP628C
WM616	CENTER BLADE, 107 x 59 MM
WM621	SPREADER ONLY, 200 x 250 MM
WM622	LATERAL BLADE, PAIR 50 MM
WM624	LATERAL BLADE, PAIR 60 MM
WM626	LATERAL BLADE, PAIR 75 MM
WM628	LATERAL BLADE, PAIR 90 MM





WM637



WM638



WM639

BALFOUR Side Blade Solid  
F/ Retractor WM221 , WM222

Catalog Number	Description
WM637	PAIR, 2 1/2" (64 MM) DEEP
WM638	PAIR, 3 1/2" (89 MM) DEEP
WM639	PAIR, 4" (102 MM) DEEP



WM577



WM578

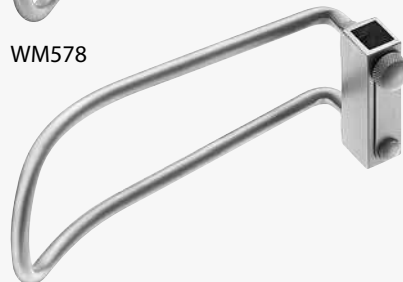

WM579

BALFOUR Side Blade Wire  
F/ Retractor DP221C , DP222C

Catalog Number	Description
WM577	PAIR, 2 1/2" (64 MM) DEEP
WM578	PAIR, 3 1/2" (89 MM) DEEP
WM579	PAIR, 4" (102 MM) DEEP

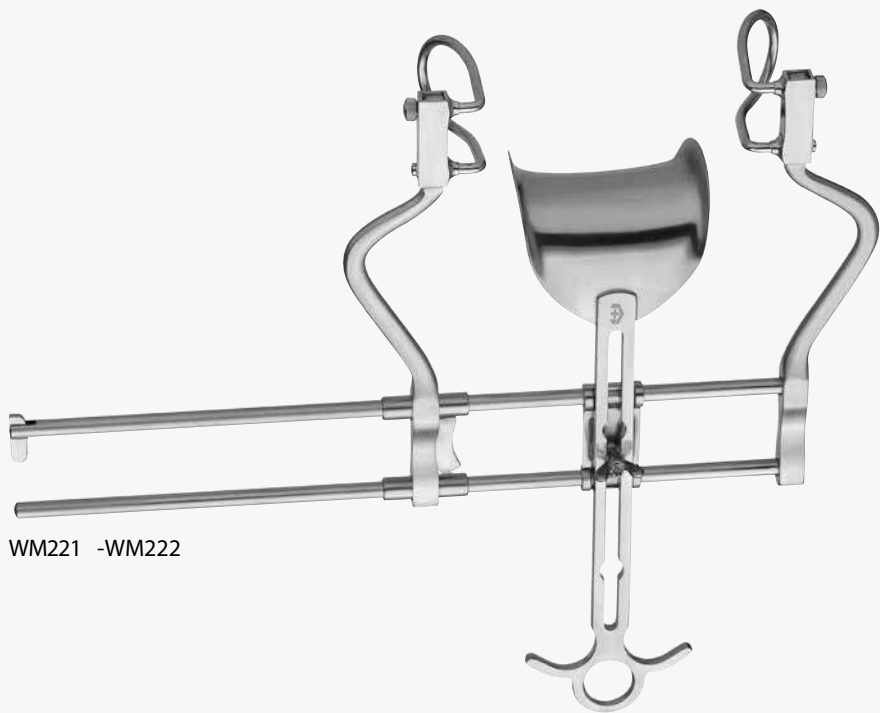

WM221 -WM222

BALFOUR Retractor W/ Exchangeable Lateral Blades

Catalog Number	Total Width (in.)	Opening Width (in.)	Description
WM221	16	10 1/2	2 PAIRS OF DETACHABLE BLADES 2 1/2" AND 3 1/2", 1 CENTER BLADE 2 3/4" x 3 1/4"
WM222	16	8 1/2	2 PAIRS OF DETACHABLE BLADES 2 1/2" AND 3 1/2", 1 CENTER BLADE 2 1/2" x 2 1/2"



WM225

BALFOUR Retractor

Catalog Number	Total Width (in.)	Opening Width (in.)	Description
WM225	13	11	2 LATERAL BLADES 2" x 2" AND 1 1/4" x 2", 1 CENTER BLADE 3" x 10 1/2"



INCHES



WM573 -WM574

DIXON Center Blade

Catalog Number	Blade	Blade Size (mm)
WM573	MALLEABLE	171 x 51
WM574	MALLEABLE	267 x 57



WM617

BALFOUR Center Blade For All  
BALFOUR Retractors

Catalog Number	Blade Size (mm)
WM617	54 x 80



WM618

Center Blade F/ IP615C

Catalog Number	Blade Size (mm)
WM618	75 x 80



BALFOUR Retractor Extension Arm

Catalog Number	Description	Length (in.)
WM065	ADULT ABDOMINAL 4" BLADE F/ RIGHT ARM	9 1/2
WM182	ADULT ABDOMINAL 4" BLADE F/ LEFT ARM	9 1/2

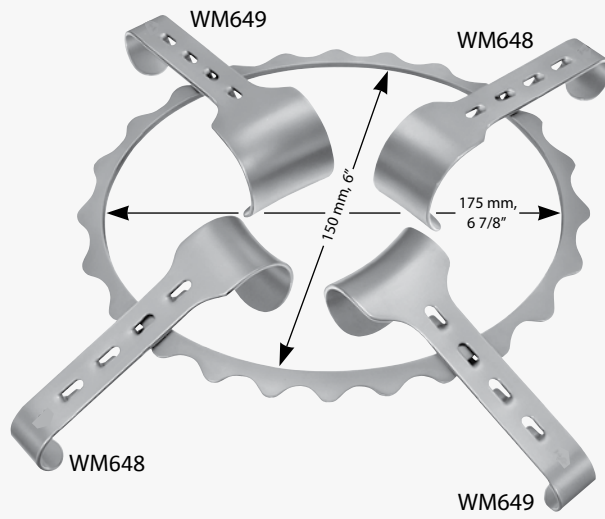

**DENIS-BROWNE Abdominal Retractor**

Catalog Number	Description
IP650C	COMPLETE SET
WM648	2 BLADES ONLY, 40 x 30 MM
WM649	2 BLADES ONLY, 40 x 40 MM
WM646	BLADE ONLY, 20 x 30 MM

WM650 Includes: 1 Frame  
2 Blades of each WM648 and WM649

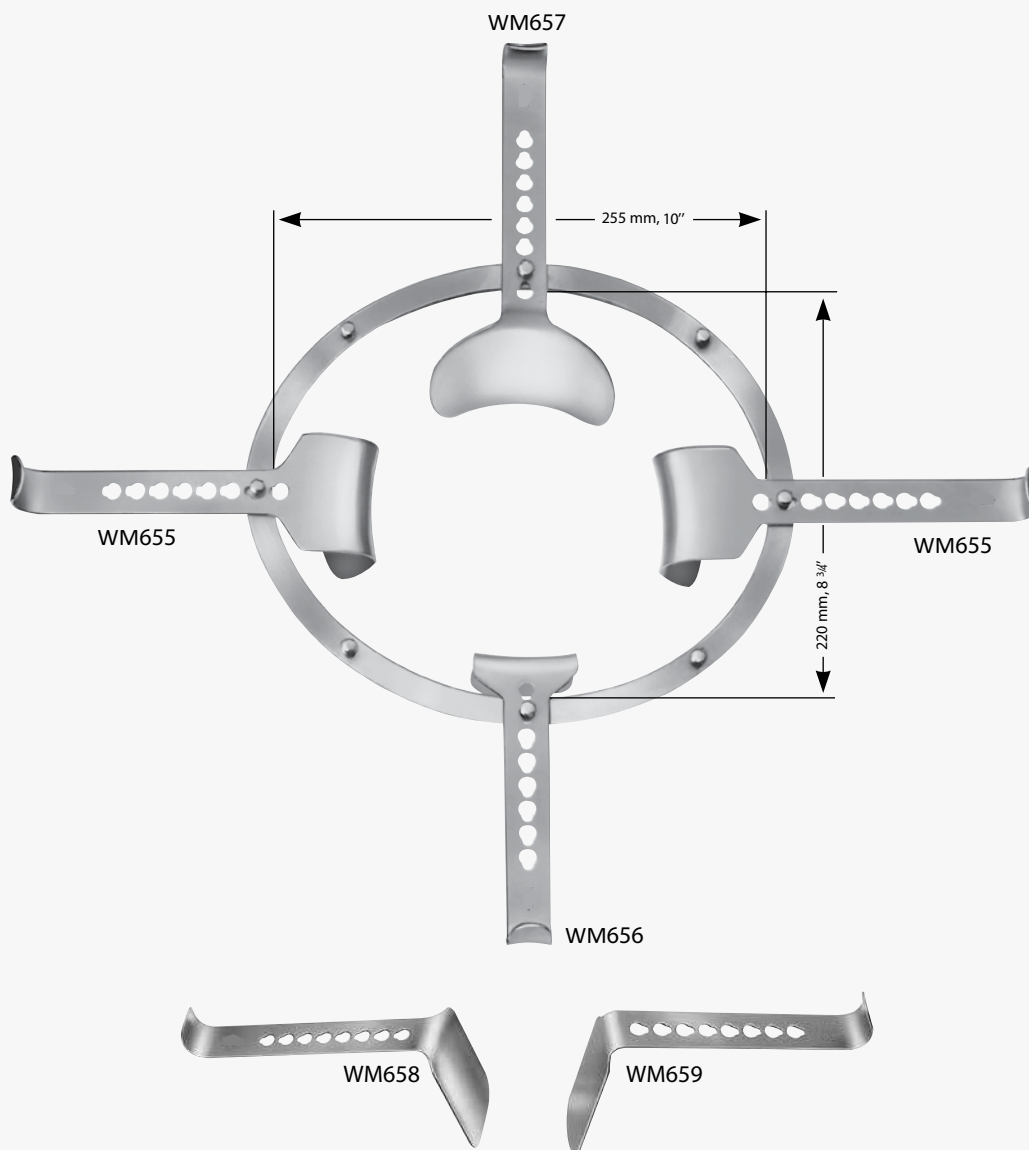

### SEMM Abdominal Retractor

Catalog Number	Description	Blade Size (mm)
WM654	COMPLETE SET	-
WM653	FRAME	-
WM655	2 BLADES	46 x 64
WM656	BLADE	53 x 54
WM657	BLADE	82 x 97
WM658	BLADE	98 x 51
WM659	BLADE	107 x 36

WM654 Includes:  
 1 Frame WM653  
 1 Blade of each WM656 , WM657 ,  
 WM658 and WM659  
 2 Blades WM655

■ For more information about Universal Ring Retractor System see our brochure number DOC380.



WM499

### Universal Ring Retractor System

Catalog Number	Description
WM499	COMPLETE SET

#### Complete System Includes:

WM497	Segmented Medium Oval Ring
WM516	Medium Oval Ring
WM506	Standard Table Clamp 18"
WM488	Horizontal Flex Bar w/ 360° Rotation 19 1/4"
WM487	Horizontal Fixed Bar 15 1/2"
WM504	Post Clamp for 1" Bar
WM503	Non-Tilting Blade Clamp (2 each)
WM510	Tilting Blade Clamp (6 each)
WM524	KELLY Retractor Blade 2" x 3" (2 each)
WM525	KELLY Retractor Blade 2" x 4"
WM526	KELLY Retractor Blade 2" x 5"
WM527	KELLY Retractor Blade 2" x 6"
WM529	Malleable Retractor Blade 1 1/2" x 6"
WM530	Malleable Retractor Blade 2" x 6"
WM532	Malleable Retractor Blade 3" x 6"
WM534	BALFOUR Bladder Blade 3" x 2 1/2"
WM536	HARRINGTON Sweet heart Blade 2 1/2" x 5"
WM546	GELPI Point Retractor Blade

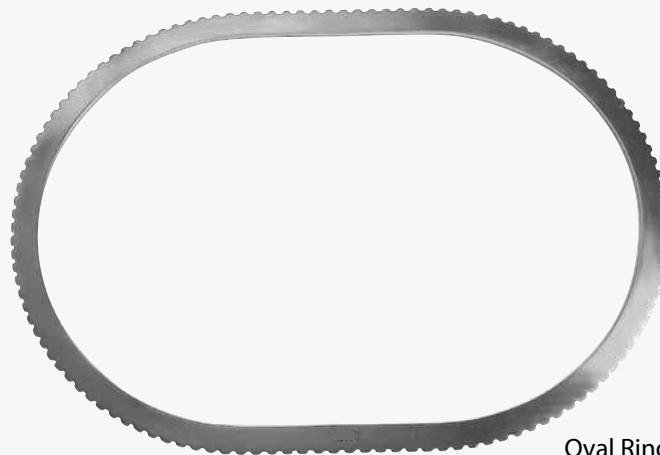

WM515-WM517

### Oval Ring

Catalog Number	Size	Width x Length (in.)
WM515	SMALL	8 1/2 x 12
WM516	MEDIUM	10 1/2 x 15
WM517	LARGE	12 1/2 x 18 1/2

INCHES

1  
2  
3  
4  
5  
6  
7

8  
9  
10  
11

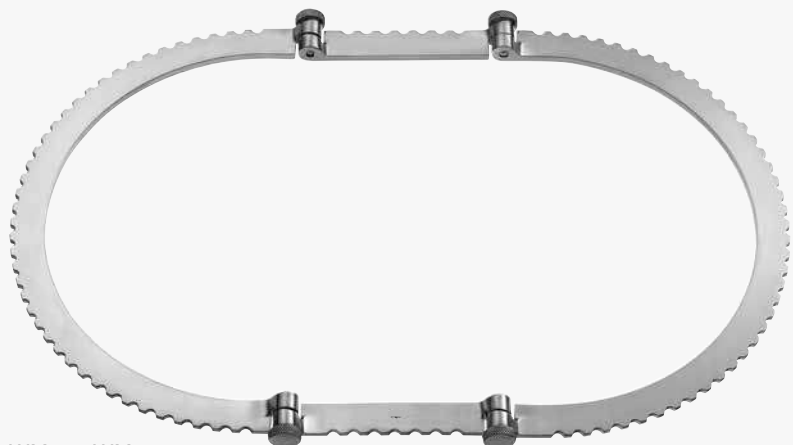

WM496-WM462

Segmented Oval Ring

Catalog Number	Size	Description	Width x Length (in.)
WM496	SMALL	INCLUDES REMOVABLE 4" SEGMENTS	8 1/2 x 14
WM497	MEDIUM	INCLUDES REMOVABLE 8" SEGMENTS	10 1/2 x 19 1/2
WM498	LARGE	INCLUDES REMOVABLE 6" SEGMENTS	12 1/2 x 19 1/2
WM462	X-LARGE	INCLUDES REMOVABLE 6" SEGMENTS	16 x 22



WM471 -WM473

Segments for Segmented Oval Ring, Pair

Catalog Number	Length (in.)
WM471	4
WM472	6
WM473	8



WM564

URRS Segmented Ring Screw

Catalog Number
WM564

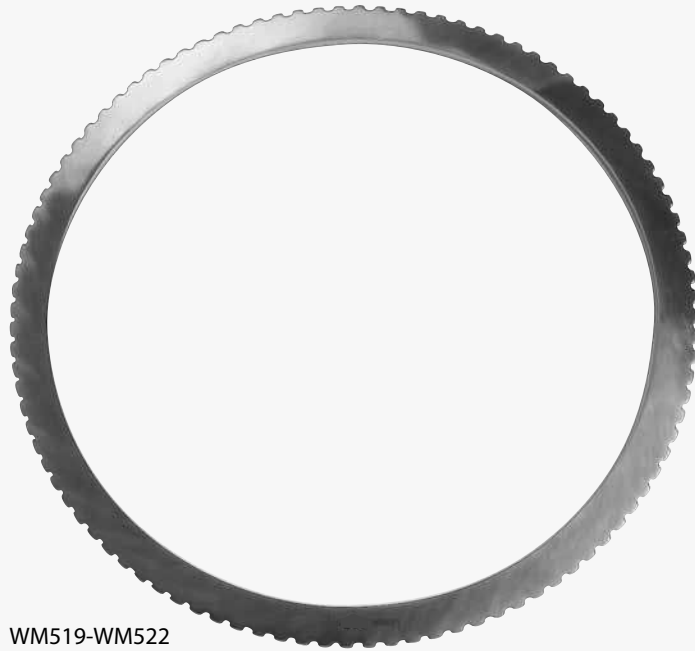

WM519-WM522

Round Ring

Catalog Number	Size	Diameter (in.)
WM519	SET	-
WM520	SMALL	8 1/2
WM521	MEDIUM	10 1/2
WM522	LARGE	12 1/2

WM519 Includes:  
1 Ring of each WM520-WM522

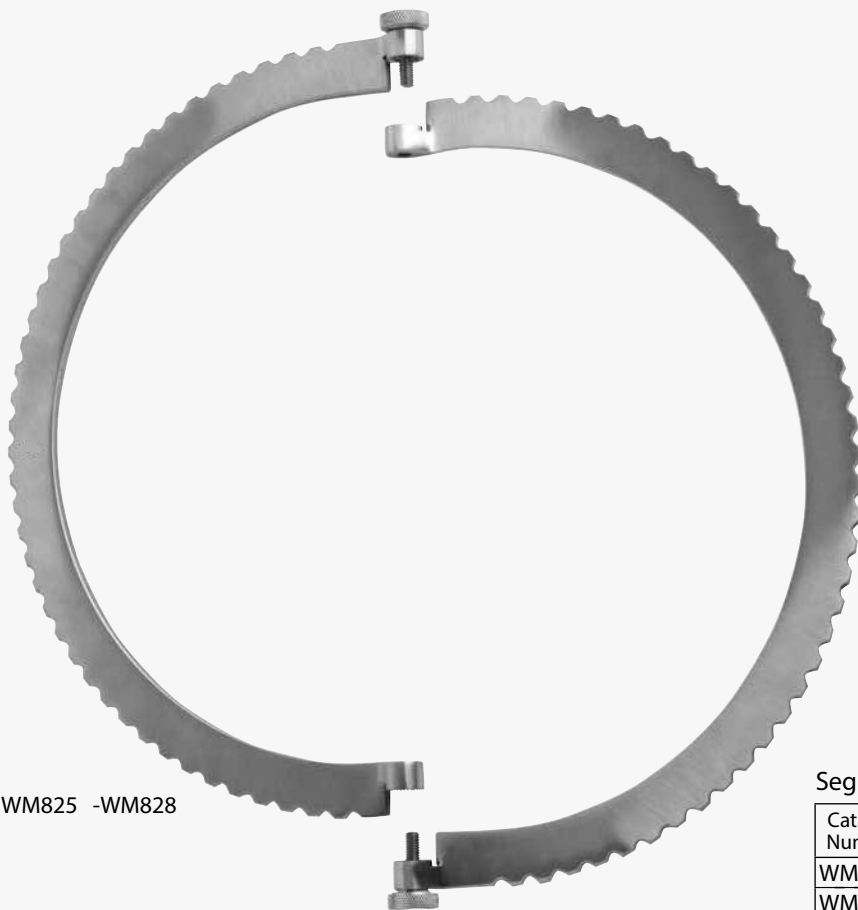

WM825 -WM828

Segmented Round Ring

Catalog Number	Size	Diameter (in.)
WM825	SMALL	8 1/2
WM826	MEDIUM	10 1/2
WM827	LARGE	12 1/2
WM828	X-LARGE	16

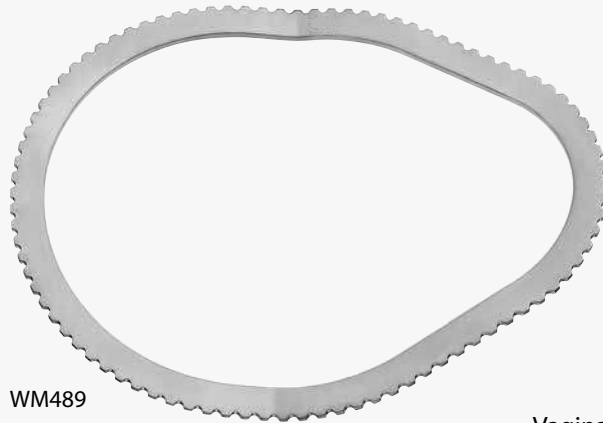

WM489

Vaginal Ring

Catalog Number	Description	Width x Length (in.)
WM489	20° ANGLE	8 x 10 1/2

INCHES



WM511

Tilt and Swivel Clamp

Catalog Number
WM511



WM973

Multi Directional Blade Clamp

Catalog Number
WM973



WM503

Non-Tilting Blade Clamp

Catalog Number
WM503



WM510

Tilting Blade Clamp

Catalog Number
WM510



WM504

Post Clamp

Catalog Number
WM504

INCHES

1

2

3

4

5

6

7

8

9

10

11



WM460 -WM506

Table Clamp

Catalog Number	Working Length (in.)	Length (in.)
WM506	15	18
WM460	21	24



WM670 -WM821

Flat Table Clamp

Catalog Number	Working Length (in.)	Total Length (in.)
WM670	11 1/2	24
WM821	17	18



WM487 -WM823

Horizontal Fixed Bar

Catalog Number	Length (in.)
WM487	15 1/2
WM823	22



WM488 -WM824

Horizontal Flex Bar W/ 360° Rotation

Catalog Number	Length (in.)
WM488	19
WM824	22 1/2



WM508-WM822

Vertical Extension Bar

Catalog Number	Length (in.)
WM508	12
WM822	14



WM509

Adapter For Attaching Handheld Retractors

Catalog Number
WM509

INCHES





WM469 -WM555

**KELLY Retractor Blade**

Catalog Number	Description	Width x Depth (in.)
WM555	-	1 x 1 1/2
WM556	-	1 x 2 1/2
WM936	-	2 x 1 1/2
WM937	-	2 x 2 1/2
WM524	-	2 x 3
WM525	-	2 x 4
WM526	-	2 x 5
WM527	-	2 x 6
WM469	BARIATRIC	2 x 8

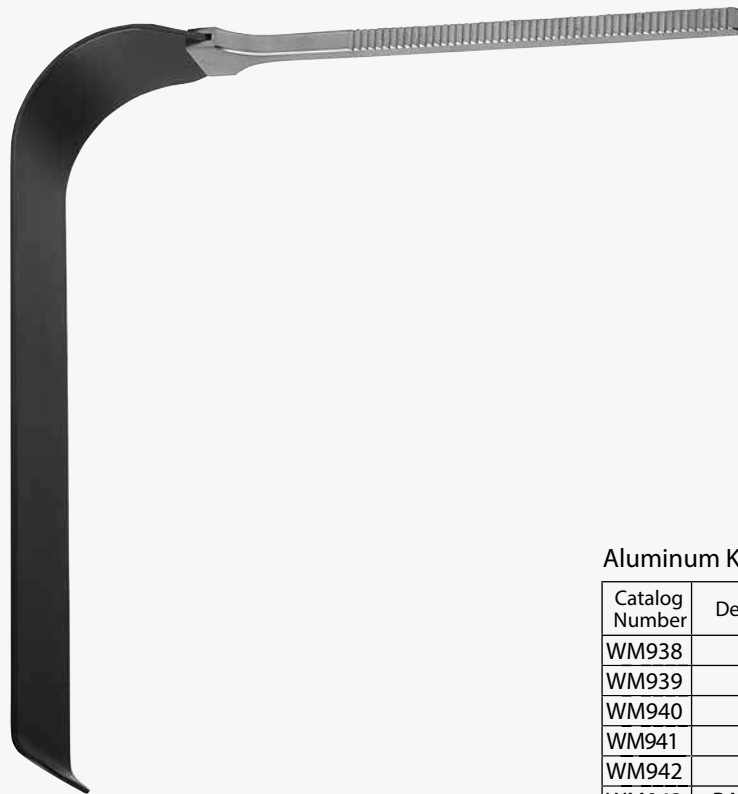

WM938-WM943

**Aluminum KELLY Retractor Blade**

Catalog Number	Description	Width x Depth (in.)
WM938	-	2 x 2 1/2
WM939	-	2 x 3
WM940	-	2 x 4
WM941	-	2 x 5
WM942	-	2 x 6
WM943	BARIATRIC	2 x 8

INCHES





WM467 -WM860

Malleable Retractor Blade

Catalog Number	Description	Width x Depth (in.)
WM860	-	3/4 x 2
WM861	-	3/4 x 3
WM862	-	1 x 1
WM863	-	1 x 4
WM864	-	1 x 5
WM865	-	1 1/2 x 3
WM866	-	1 1/2 x 4
WM529	-	1 1/2 x 6
WM867	-	1 1/2 x 8
WM530	-	2 x 6 1/2
WM531	-	2 x 8
WM463	BARIATRIC	2 x 10
WM532	-	3 x 6
WM464	BARIATRIC	3 x 10
WM466	BARIATRIC	3 x 12
WM869	BARIATRIC	4 x 8
WM465	BARIATRIC	4 x 10
WM467	BARIATRIC	4 x 12



WM954-WM959

Aluminum Malleable Retractor Blade, Flat

Catalog Number	Description	Width x Depth (in.)
WM954	-	1 1/2 x 6
WM955	-	2 x 6
WM956	-	2 x 8
WM957	-	3 x 6
WM958	BARIATRIC	2 x 10
WM959	BARIATRIC	3 x 10



WM557-WM559

RICHARDSON Retractor

Catalog Number	Width x Depth (in.)
WM557	3/4 x 1
WM558	3/4 x 2
WM559	1 x 1 1/4



WM470 -WM534

BALFOUR Bladder Blade

Catalog Number	Description	Width x Depth (in.)
WM534	-	3 x 2 1/2
WM535	-	3 x 3 1/4
WM470	BARIATRIC	3 x 3 1/2

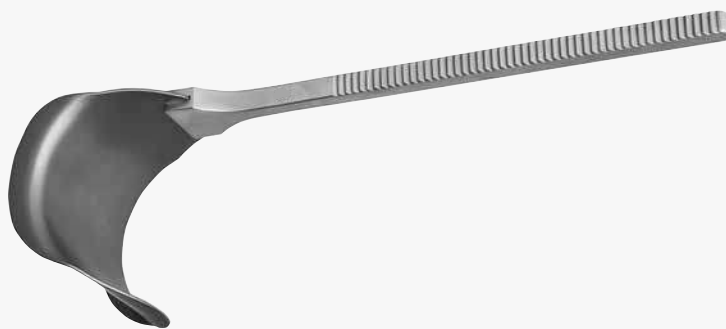

WM829-WM830

Aluminum BALFOUR Bladder Blade

Catalog Number	Width x Depth (in.)
WM829	2 x 2 3/8
WM830	3 x 2 1/2

INCHES





WM968 -WM969

MAYO Retractor Blade

Catalog Number	Width x Depth (in.)
WM968	1 1/4 x 1 1/4
WM969	2 x 2



WM970

Aluminum MAYO Retractor Blade

Catalog Number	Width x Depth (in.)
WM970	2 3/4 x 2



WM537-WM539

DEAVER Retractor Blade

Catalog Number	Width x Depth (in.)
WM537	1 x 4 1/2
WM538	1 1/2 x 4 1/2
WM539	2 x 4 1/2

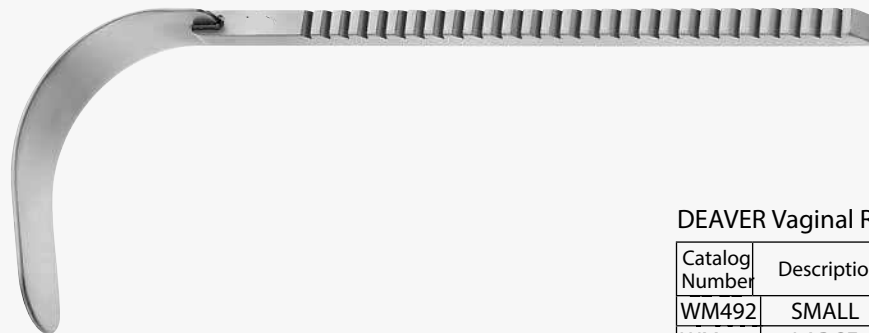

WM492-WM493

DEAVER Vaginal Retractor Blade

Catalog Number	Description	Width x Depth (in.)
WM492	SMALL	1 x 3 1/2
WM493	LARGE	1 x 5

INCHES



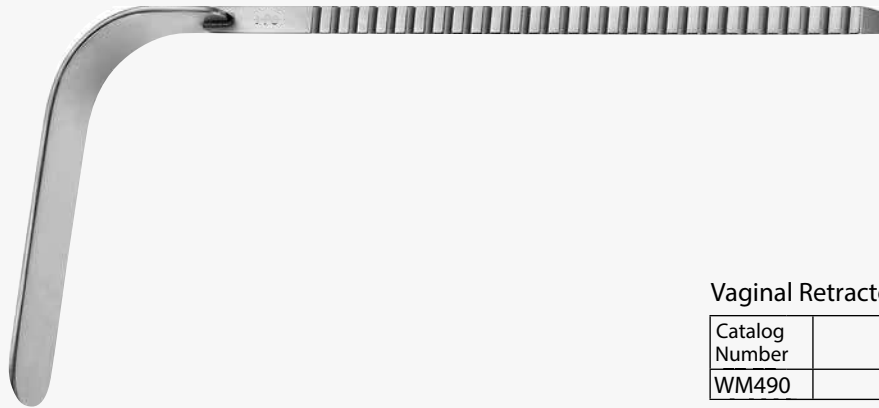

WM490

Vaginal Retractor Posterior Blade

Catalog Number	Width x Depth (in.)
WM490	1 x 4 1/2



WM491

Vaginal Retractor Lateral Blade

Catalog Number	Width x Depth (in.)
WM491	1 x 3

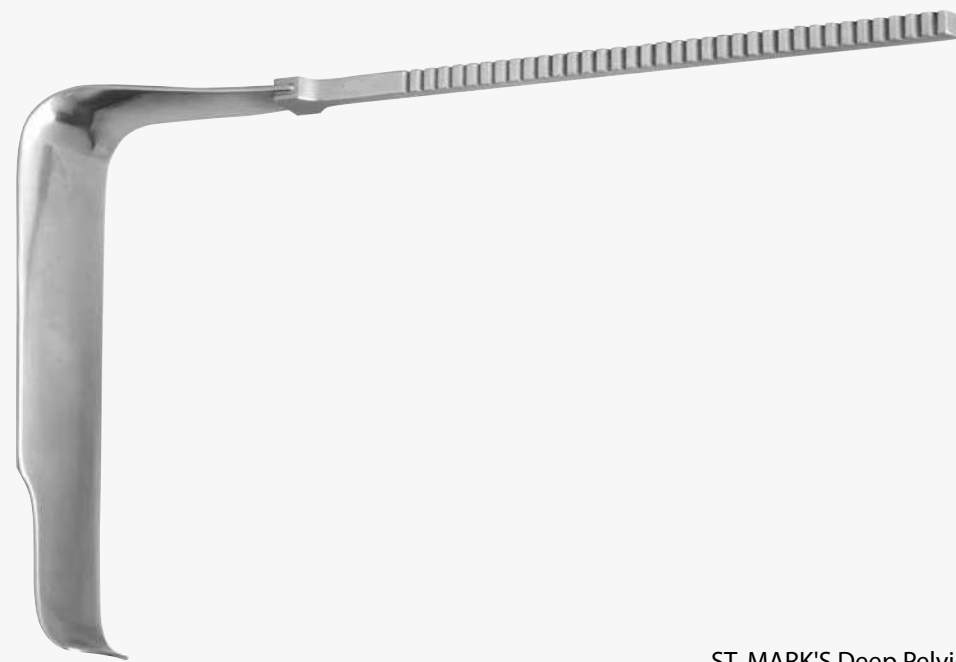

WM871

ST. MARK'S Deep Pelvic Retractor Blade

Catalog Number	Width x Depth (in.)
WM871	2 3/8 x 7 1/2

INCHES

1  
2  
3  
4  
5  
6  
7  
8  
9  
10  
11



WM494-WM495

Rectal Blade

Catalog Number	Description	Width x Depth (in.)
WM494	SMALL	7/8 x 2 7/8
WM495	LARGE	7/8 x 3 7/8

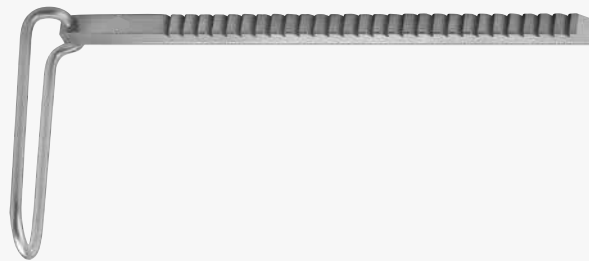

WM541

Skin Incision Blade

Catalog Number	Width x Depth (in.)
WM541	1 1/8 x 3 1/4

INCHES

1  
2  
3  
4  
5  
6  
7  
8  
9  
10  
11



WM543-WM832

HARRINGTON Sweetheart Blade

Catalog Number	Description	Width x Depth (in.)
WM543	-	1 1/2 x 5
WM544	-	2 1/2 x 5 5/8
WM468	BARIATRIC	3 1/2 x 10
WM832	BARIATRIC	4 1/2 x 10



WM833-WM835

Aluminum HARRINGTON Sweetheart Blade

Catalog Number	Description	Width x Depth (in.)
WM833	-	2 1/2 x 4
WM834	-	3 1/2 x 8
WM835	BARIATRIC	3 1/2 x 10



WM546

GELPI Point Retractor Blade

Catalog Number
WM546

INCHES

1

2

3

4

5

6

7

8

9

10

11

INCHES



WM548-WM549

SCOVILLE Hook Retractor Blade

Catalog Number	Description	Depth (in.)
WM549	SMALL	2
WM548	LARGE	3 1/4



WM566-WM568

Rake Retractor

Catalog Number	Description	Width x Depth (in.)
WM566	3 PRONGS	2/3 x 3/4
WM567	4 PRONGS	1 x 1/3
WM568	PRONGS	3/4 x 1/3



WM551-WM553

MEYERDING Retractor Blade

Catalog Number	Width x Depth (in.)
WM551	1 x 3 1/3
WM552	2 x 3 3/4
WM553	2/3 x 2 1/3



WM962-WM965

Aluminum Renal Retractor Blade

Catalog Number	Width x Depth (in.)
WM962	1 x 4
WM963	1 x 6
WM964	1 x 8
WM965	1 x 10



WM966-WM967

Aluminum Splanchnic Retractor Blade

Catalog Number	Width x Depth (in.)
WM966	2 x 10
WM967	3 x 8



WM960 -WM961

Perforated Super Malleable Retractor Blade

Catalog Number	Width x Depth (in.)
WM960	2 x 9
WM961	3 x 9



WM870

YU-HOLTGREWE Malleable Retractor Blade

Catalog Number	Width x Depth (in.)
WM870	2 1/2 x 6



WM001

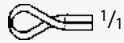

WM001

FINSSEN Retractor

Catalog Number	Tip	Blade End	Length (in.)
WM001	SHARP	2 x 3 PRONGS	2



WM002

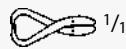

WM002

FINSSEN Retractor

Catalog Number	Tip	Blade End	Length (in.)
WM002	SHARP	3 x 4 PRONGS	2 3/4

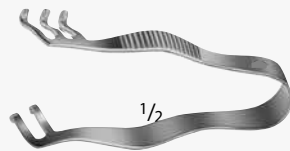

WM003

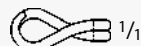

WM003

FINSSEN Modified Retractor

Catalog Number	Tip	Blade End	Length (in.)
WM003	BLUNT	2 x 3 PRONGS	3



WM005

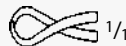

WM005

FINSSEN Retractor

Catalog Number	Tip	Blade End	Length (in.)
WM005	SHARP	3 x 4 PRONGS	2 3/4



WM014

PARSONNET Epicardial Retractor

Catalog Number	Tip	Blade End	Length (in.)
WM014	SHARP	3 x 3 PRONGS	2



WM006 -WM007



WM006

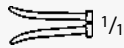

WM007

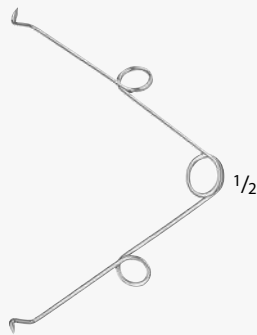

WM471

### Spring Wire Retractor

Catalog Number	Tip	Prongs	Length (in.)
WM006	BLUNT	3 x 3	1 3/4
WM007	BLUNT	3 x 3	2 1/4
WM471	SHARP	1 x 1	3

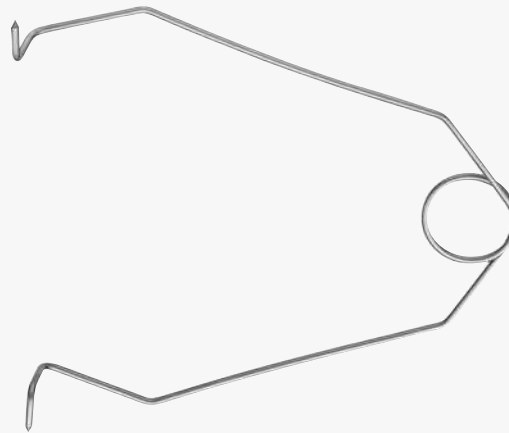

WM196 -WM777

### Spring Wire Retractor

Catalog Number	Size	Length (in.)
WM777	SMALL	5
WM778	MEDIUM	5 1/8
WM196	LARGE	9

INCHES

1  
2  
3  
4  
5  
6  
7  
8  
9  
10  
11



WM010 -WM011



WM010



WM011

ALM Retractor

Catalog Number	Tip	Blade End	Length (in.)
WM010	SHARP	4 x 4 PRONGS	2 3/4
WM011	SHARP	4 x 4 PRONGS	4



WM008 -WM015



WM008



WM015

HEISS Self-Retaining Retractor

Catalog Number	Tip	Blade End	Length (in.)
WM015	SHARP	4 x 4 PRONGS	4
WM008	BLUNT	4 x 4 PRONGS	4

INCHES

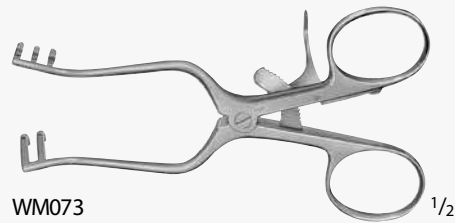

WM073  $\frac{1}{2}$



WM073  $\frac{1}{1}$



WM438  $\frac{1}{2}$



WM438  $\frac{1}{1}$

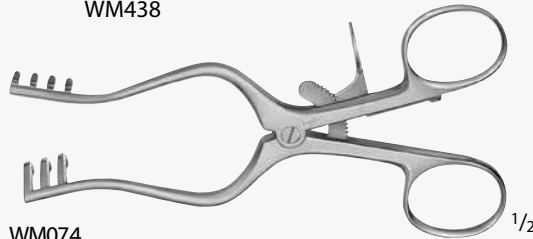

WM074  $\frac{1}{2}$

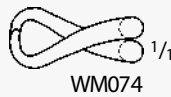

WM074  $\frac{1}{1}$

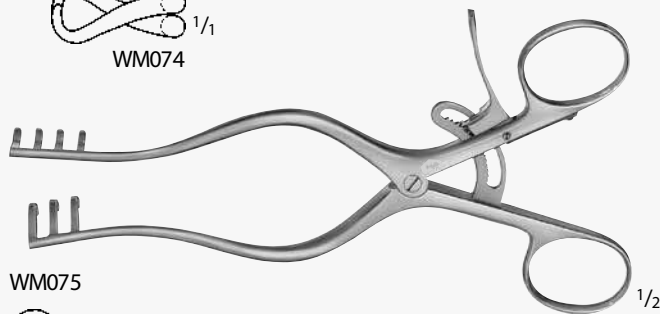

WM075  $\frac{1}{2}$

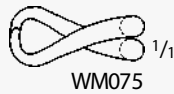

WM075  $\frac{1}{1}$

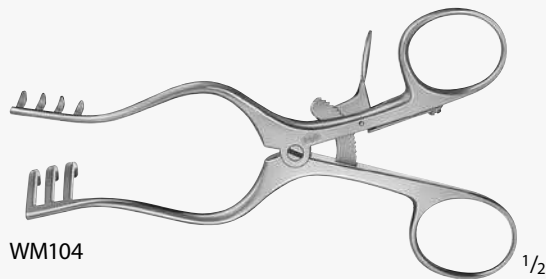

WM104  $\frac{1}{2}$

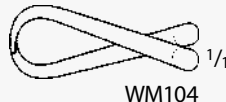

WM104  $\frac{1}{1}$

**WEITLANER Retractor**

Catalog Number	Tip	Blade End	Length (in.)
WM073	BLUNT	2 x 3 PRONGS	4 1/4
WM438	BLUNT	3 x 3 PRONGS	4 1/4
WM074	BLUNT	3 x 4 PRONGS	5 1/8
WM075	BLUNT	3 x 4 PRONGS	6 1/2
WM104	BLUNT/DEEP	3 x 4 PRONGS	5 1/8



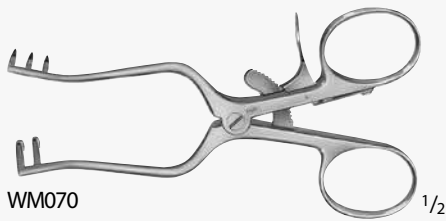

WM070

1/2



WM070



WM068

1/2

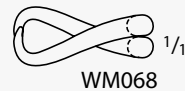

WM068



WM071

1/2



WM071



WM066

1/2



WM066

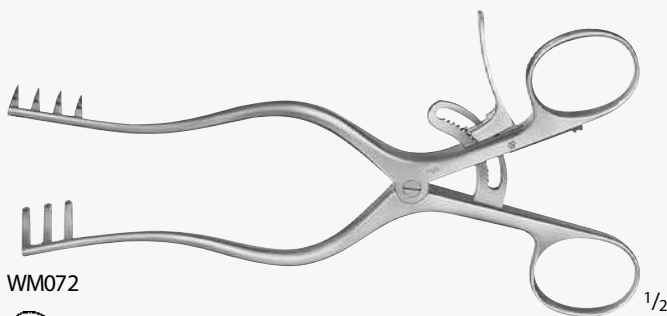

WM072

1/2



WM072



WM067

1/2

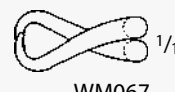

WM067



WM101

1/2



WM101

**WEITLANER Retractor**

Catalog Number	Tip	Blade End	Length (in.)
WM070	SHARP	2 x 3 PRONGS	4 1/4
WM071	SHARP	3 x 4 PRONGS	5 1/8
WM072	SHARP	3 x 4 PRONGS	6 1/2
WM101	SHARP/DEEP	3 x 4 PRONGS	5 1/8
WM066	SEMI-S	2 x 3 PRONGS	4 1/4
WM067	SEMI-S	3 x 4 PRONGS	5 1/8
WM068	SEMI-S	3 x 4 PRONGS	6 1/2



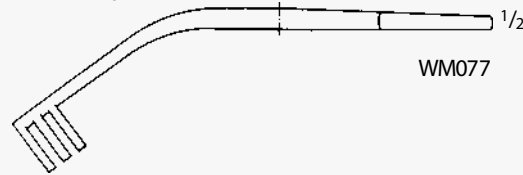

WULLSTEIN Retractor

Catalog Number	Tip	Blade End	Length (in.)
WM076	SHARP	3 x 3 PRONGS	5
WM077	BLUNT	3 x 3 PRONGS	5

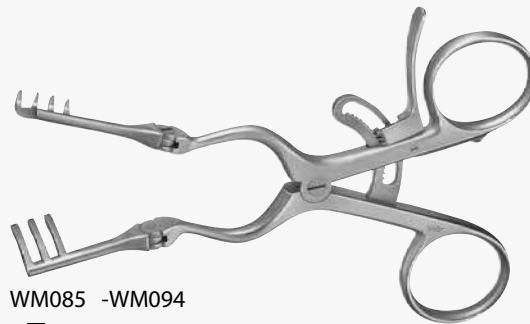

WM085 - WM094



WM085 - WM094

Baby ADSON Retractor, Hinged

Catalog Number	Tip	Blade End	Length (in.)
WM085	SEMI-S	3 x 4 PRONGS	5 1/2
WM094	SEMI-S	3 x 4 PRONGS	6 1/2



WM007

Baby ADSON Retractor, Angled

Catalog Number	Tip	Blade End	Length (in.)
WM007	BLUNT	4 x 4 PRONGS	7 1/2

INCHES

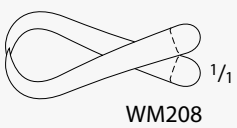
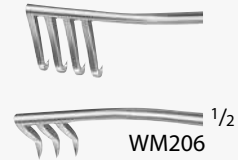
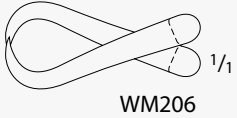
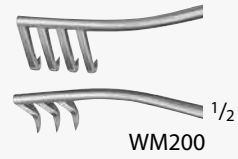
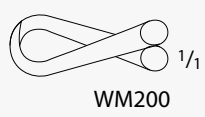
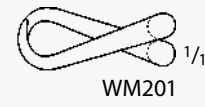

**WEITLANER Retractor**

Catalog Number	Tip	Blade End	Length (in.)
WM200	SHARP	3 x 4 PRONGS	7 7/8
WM206	SHARP	3 x 4 PRONGS	9 1/2
WM208	SHARP	5 x 6 PRONGS	10
WM201	BLUNT	3 x 4 PRONGS	7 7/8
WM207	BLUNT	3 x 4 PRONGS	9 1/2
WM209	BLUNT	5 x 6 PRONGS	10

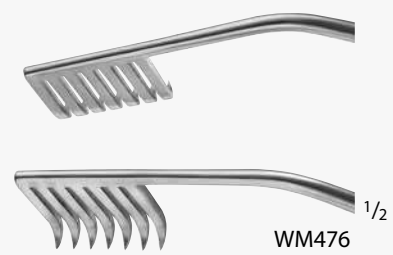

**MISKIMON Cerebellar Retractor**

Catalog Number	Tip	Blade End	Length (in.)
WM476	SHARP	7 x 7 PRONGS	7 7/8



WWW.WYZZMEDICAL.COM

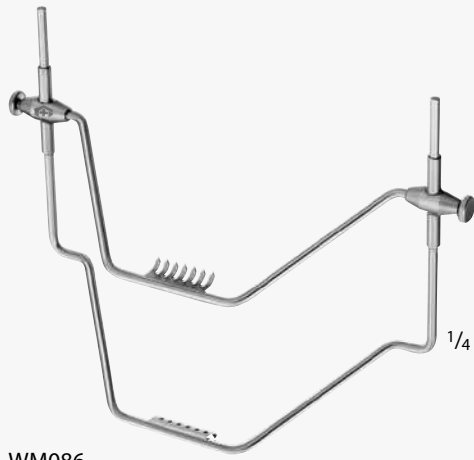

WM086

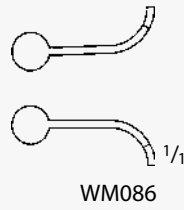

WM086

Thyroid Retractor

Catalog Number	WM086
----------------	-------

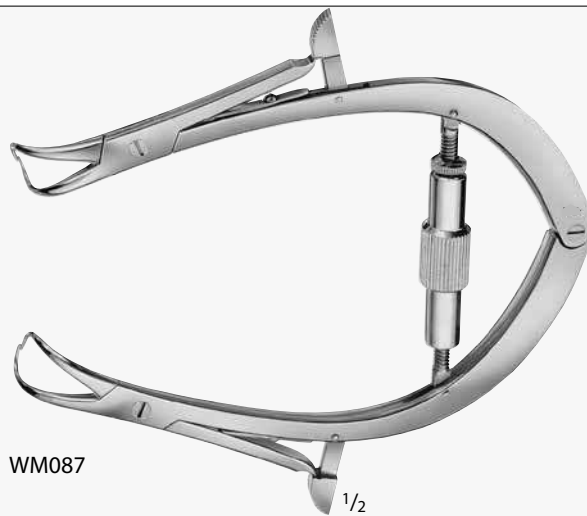

WM087

JOLL (FRIEDMANN) Thyroid/Vaginal Retractor

Catalog Number	Length (in.)
WM087	6 1/8



WM088

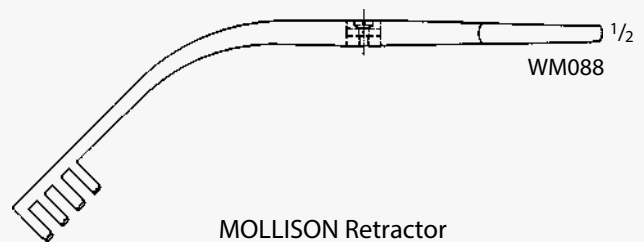

WM088

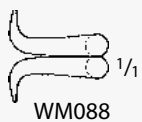

WM088

MOLLISON Retractor

Catalog Number	Tip	Blade End	Length (in.)
WM088	SHARP	4 x 4 PRONGS	6 1/8





WM112

IP112C 1/1

MAYO-ADAMS Retractor

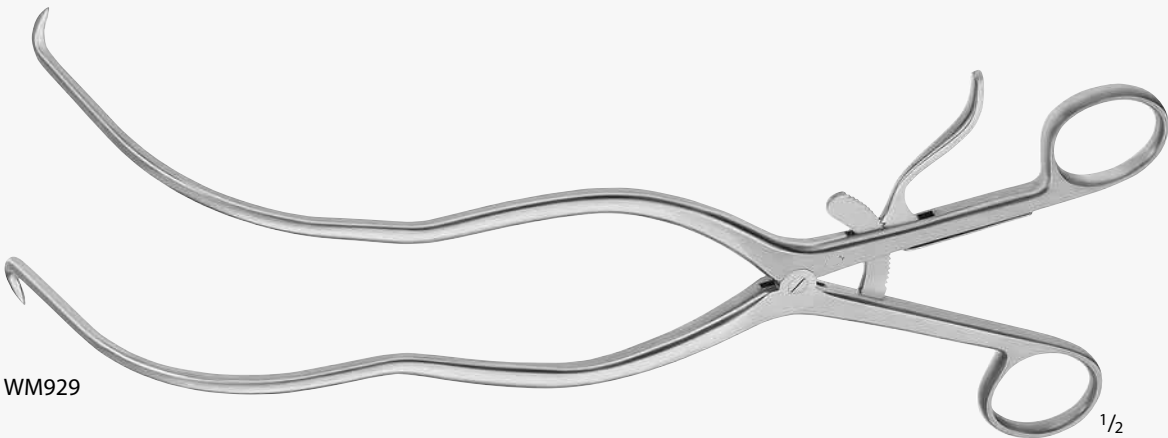
Catalog Number	Length (in.)
WM112	6 1/2



WM929

WM929 1/1

WILSTE-GELPI Retractor

Catalog Number	Tip	Tip Size (mm)	Length (in.)
WM929	SHARP	70	11

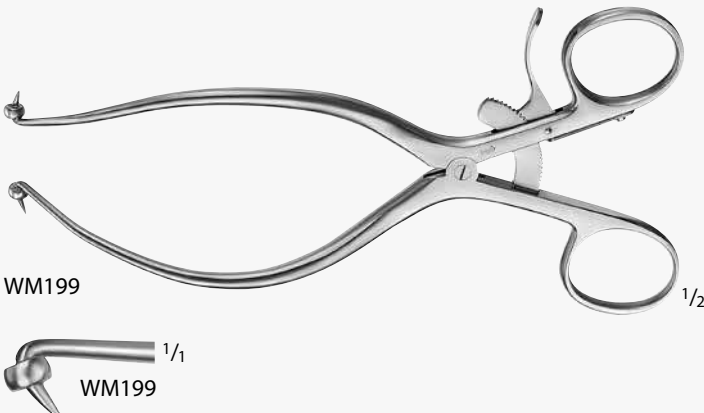

WM199

WM199 1/1

GELPI Perineal Retractor

Catalog Number	Tip	Length (in.)
WM199	SHARP WITH BALL STOPS	7



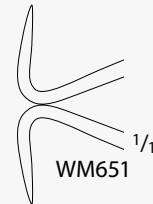
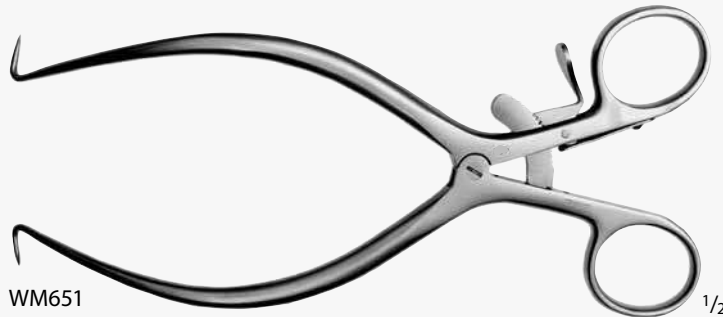
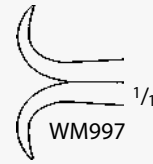
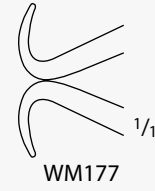
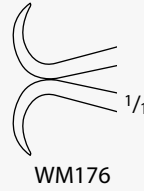

GELPI Vaginal Retractor

Catalog Number	Tip	Length (in.)
WM176	SHARP	3 1/2
WM996	SHARP	5 1/4
WM997	SHARP	6 7/8
WM651	SHARP	7 1/4
WM177	BLUNT	4 1/2

INCHES



WM998

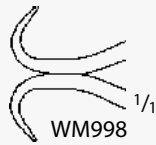

WM998

DEBAKEY Femur Retractor for Children

Catalog Number	Tip	Length (in.)
WM998	SHARP	4

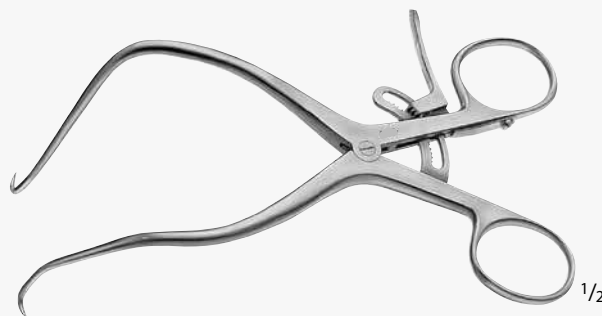

WM999

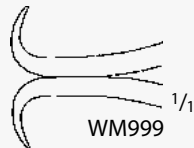

WM999

DEBAKEY Femur Retractor for Adults

Catalog Number	Tip	Length (in.)
WM999	SHARP	5 1/2



WM993

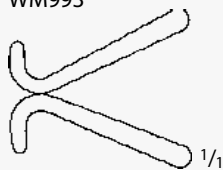

WM993

JACKSON-BURROWS Retractor

Catalog Number	Tip	Length (in.)
WM993	BLUNT	7

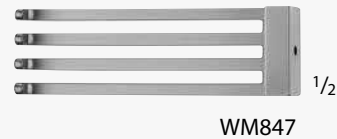
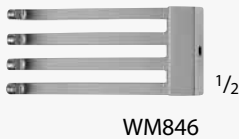
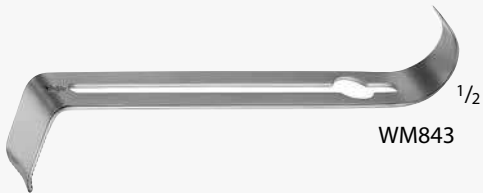

### HENLY Retractor

Catalog Number	Description	Blade Size (mm)	Blade Size (in.)	Length (in.)
WM120	COMPLETE SET	-	-	7
WM842	CENTER BLADE, SMALL	19 x 16	3/4 x 5/8	-
WM843	CENTER BLADE, MEDIUM	25 x 16	1 x 5/8	-
WM844	CENTER BLADE, LARGE	32 x 16	1 1/4 x 5/8	-
WM848	CENTER BLADE, X-LARGE	76 x 16	3 x 5/8	-
WM845	SIDE BLADE, PAIR (4 PRONGS)	25 x 25	1 x 1	-
WM846	SIDE BLADE, PAIR (4 PRONGS)	51 x 25	2 x 1	-
WM847	SIDE BLADE, PAIR (4 PRONGS)	76 x 22	3 x 1	-
WM849	FRAME ONLY	-	-	7

WM120 Complete Set Includes:  
 1 Frame,  
 1 each of 4 Center Blades,  
 1 Pair of each of 3 Side Blades  
 Materials in set sold separately: WM842 -WM849



WM581 1/2

WM583 22 mm

WM586 22 mm

WM584 22 mm

IP589C 23 mm

WM585

70 mm, 2 3/4"

95 mm, 3 3/4"

140 mm, 5 1/2"

1/2

**PARKS Rectal Spreader**

Catalog Number	Item	Length (mm)
WM585	COMPLETE SET	-
WM581	SPREADER ONLY	-
WM582	CENTER BLADE	-
WM583	SIDE BLADE, PAIR	70
WM586	SIDE BLADE, PAIR	90
WM584	SIDE BLADE, PAIR	93
WM589	SIDE BLADE, PAIR	150

Set Includes:  
1 Spreader WM581  
1 Center Blade WM582  
2 Blades of each WM853 and WM584

110 mm, 4 1/4"

165 mm, 6 1/2"

155 mm, 6 1/8"

WM906

**SMITH-BUIE Rectal Retractor**

Catalog Number	Blade Size (mm)
WM906	58 x 23



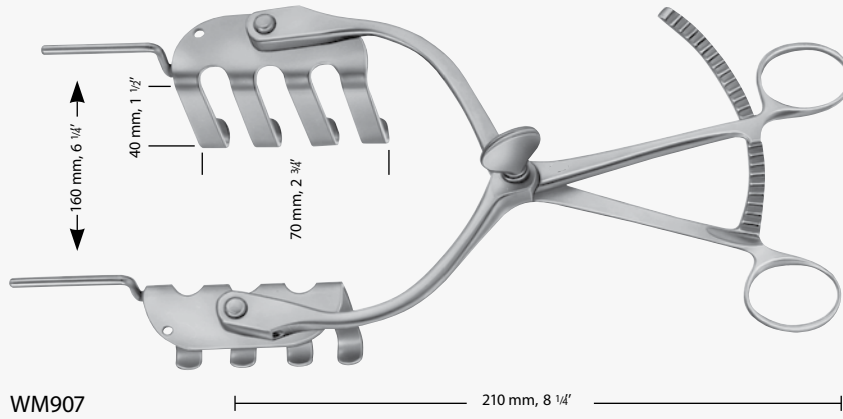

WM907

210 mm, 8 1/4"

ST. MARKS MODIFIED GIRONA Perineal Retractor

Catalog Number
WM907

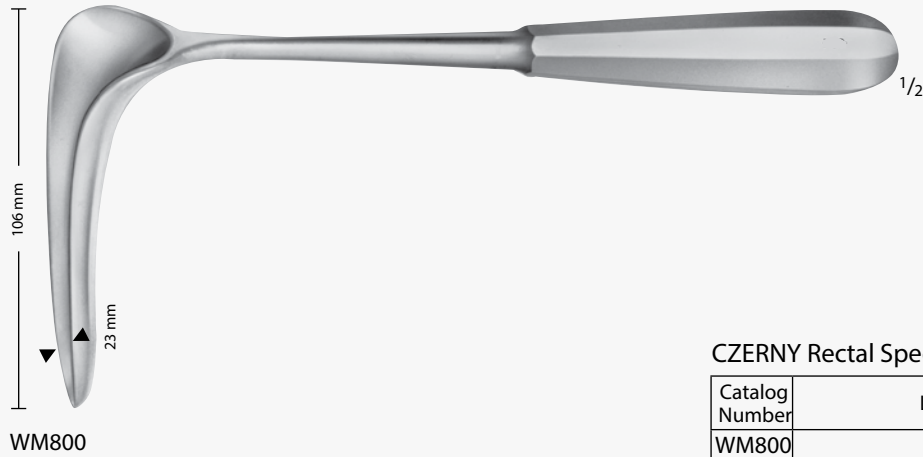

WM800

CZERNEY Rectal Speculum

Catalog Number	Length (in.)
WM800	8 7/8



WM772 -WM178

SAWYER Retractor

Catalog Number	Size	Blade Size (mm)	Length (in.)
WM773	SMALL	70 x 19	10 3/4
WM772	MEDIUM	82 x 29	10 3/4
WM178	LARGE	97 x 38	11 5/8

INCHES

1

2

3

4

5

6

7

8

9

10

11



WM774 -WM776

HILL-FERGUSSON Rectal Retractor

Catalog Number	Blade Size (mm)	Length (in.)
WM775	64 x 24	8 1/4
WM774	76 x 35	8 1/4
WM776	76 x 32	8 1/4



WM820



WM821

SIMS Rectal Speculum

Catalog Number	Blade	Length (in.)
WM820	SOLID	6 1/4
WM821	FENESTRATED	6 1/4

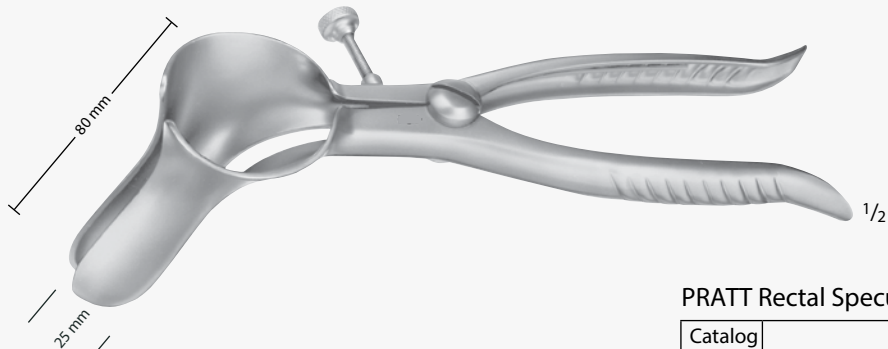

WM831

PRATT Rectal Speculum

Catalog Number	Length (in.)
WM831	8

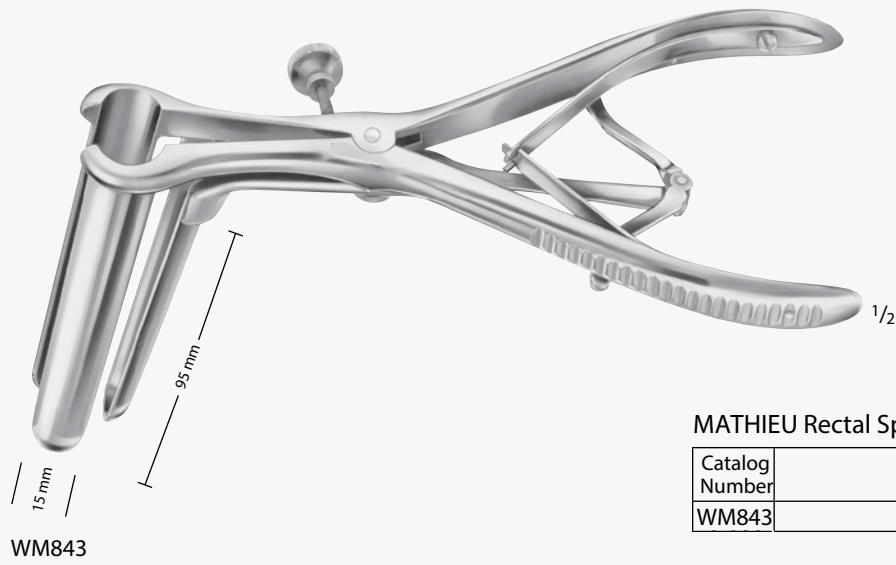

MATHIEU Rectal Speculum

Catalog Number	Length (in.)
WM843	8 1/2



IVES-FANSLER Anuscope

Catalog Number	Length (in.)
WM880	5 3/4



Rectal Speculum

Catalog Number	Length (in.)
WM274	2 3/8

INCHES





WM160

### CHELSEA-EATON Anal Speculum

Catalog Number	Size	Diameter (mm)	Finish	Length (in.)
WM160	SMALL	30	MIRROR FINISH	2 1/2



WM179 , WM203 , WM288

### HIRSCHMANN Rectal Speculum

Catalog Number	Size	Blade Size (mm)
WM203	SMALL	60 x 16
WM288	MEDIUM	72 x 19
WM179	LARGE	89 x 23



WM284 , WM162 -WM163

BRINKERHOFF Rectal Speculum

Catalog Number	Size	Diameter (in.)	Length (in.)
WM162	SMALL	1/2 x 1	3 3/4
WM163	MEDIUM	5/8 x 1	3 3/4
WM284	LARGE	3/4 x 1 1/4	4 1/2



WM882 -WM887

KELLY Sphincteroscope

Catalog Number	Diameter (mm)	Working Length (mm)	Length (in.)
WM882	21	54	6 1/4
WM887	22	140	5 1/2
WM883	25	50	6 1/4

INCHES

1  
2  
3  
4  
5  
6  
7  
8  
9  
10  
11



WM990

<sup>1</sup>/<sub>2</sub> MCGIVNEY Hemorrhoidal Forceps

Catalog Number	Length (in.)
WM990	7 1/4



WM991

<sup>1</sup>/<sub>2</sub>



992208

<sup>1</sup>/<sub>1</sub>



<sup>1</sup>/<sub>1</sub>

WM993

RUDD Hemorrhoidal Ligator

Catalog Number	Description	Length (in.)
WM991	COMPLETE SET	12 3/8
WM992	LIGATOR, INCLUDES CONE	12 1/2
992208	LIGATOR CONE ONLY	-
WM993	LATEX FREE RINGS F/ LQ991C , 100/PKG	-

WM991 Complete Set Includes:  
WM992 and WM993

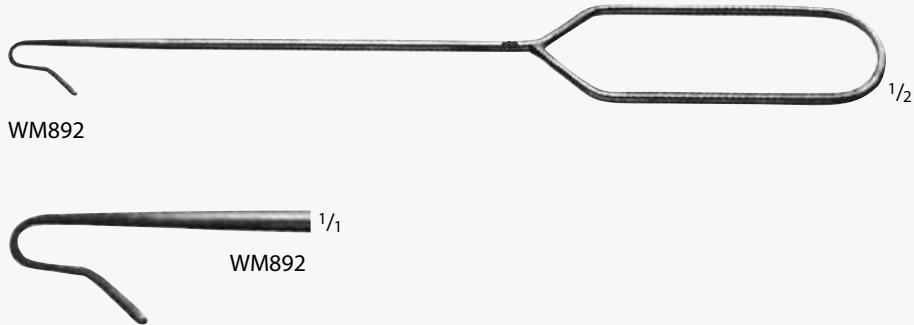

WM892

1/2

WM892

1/1

STEWART Crypt Hook

Catalog Number	Length (in.)
WM892	9

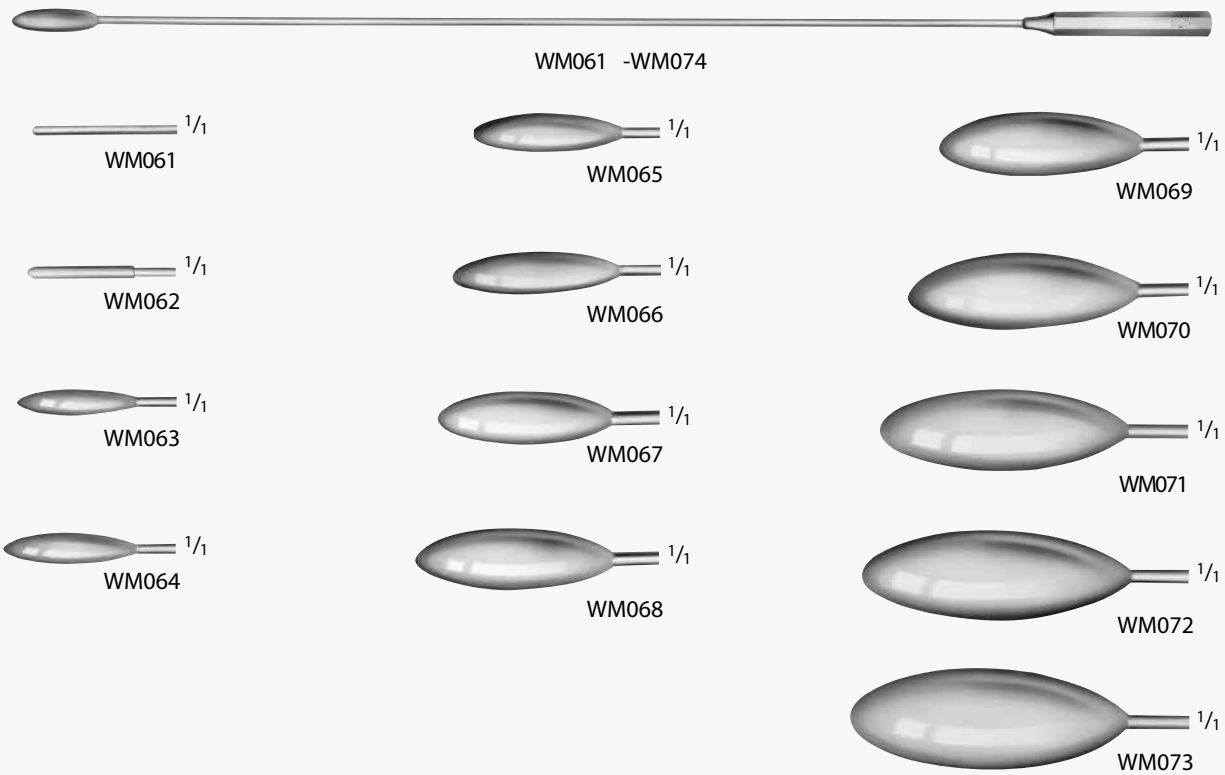

BAKES Bile-Duct Dilator

Catalog Number	Tip Size (mm)	Length (in.)
WM061	1	12 3/8
WM062	2	12 3/8
WM063	3	12 3/8
WM064	4	12 3/8
WM065	5	12 3/8
WM066	6	12 1/2
WM067	7	12 1/2
WM068	8	12 1/2
WM069	9	12 1/2
WM070	10	12 1/2
WM071	11	12 1/2
WM072	12	12 1/2
WM073	13	12 1/2
WM074	SET, 3-11 mm	-

INCHES

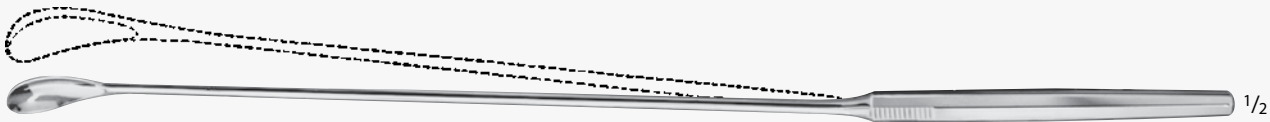

WM168 -WM175

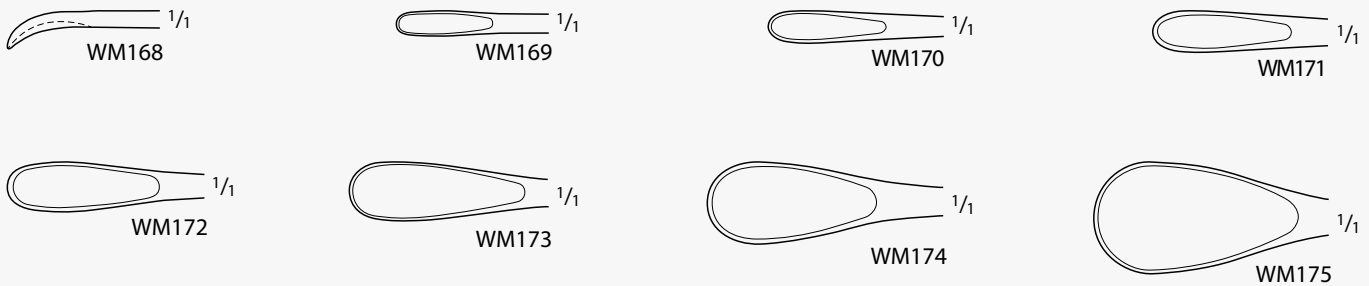

LUER-KOERTE Scoops, Malleable Shaft

Catalog Number	Tip Size (mm)	Length (in.)
WM168	2.8	12 3/4
WM169	3.4	12 3/4
WM170	4.3	12 3/4
WM171	5.5	12 3/4
WM172	6.7	12 3/4
WM173	8.0	12 3/4
WM174	11.0	12 3/4
WM175	15.0	12 3/4



WM003 -WM006

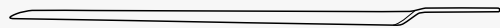

WM003 -WM006

Director W/ Tongue

Catalog Number	Blade Shape	Length (in.)
WM003	STR	5 1/8
WM004	STR	5 3/4
WM006	STR	6 1/4



WM010

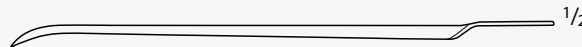

WM010

DOYEN Director W/ Tongue

Catalog Number	Blade Shape	Length (in.)
WM010	CVD	5 3/4

INCHES



WM336

Grooved Director W/ Tongue

Catalog Number	Length (in.)
WM336	4 1/2



WM012

WM012 NELATON Director

Catalog Number	Blade Shape	Length (in.)
WM012	CVD	6 1/4



WM015

WM015 Director, W/ Probe Tip & Tongue

Catalog Number	Diam. of Tip (mm)	Blade Shape	Length (in.)
WM015	3.3	STR	5 1/2



WM020

WM020 BRODIE Director, W/ Probe Tip & Tongue

Catalog Number	Diam. of Tip (mm)	Blade Shape	Length (in.)
WM020	3.5	STR	7 7/8



WM170

WM170 Probe

Catalog Number	Diam. of Tip (mm)	Length (in.)
WM170	1.4	6 1/4

1

2

3

4

5

6

7

8

9

10

11

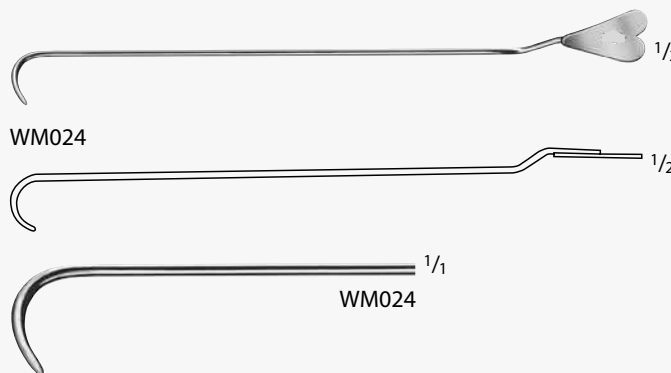
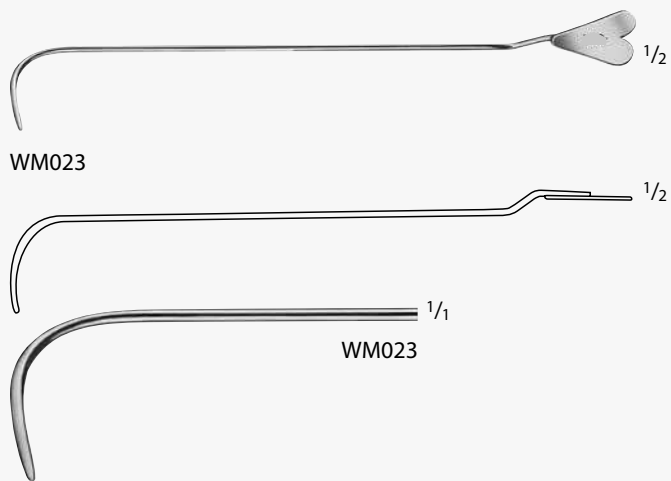
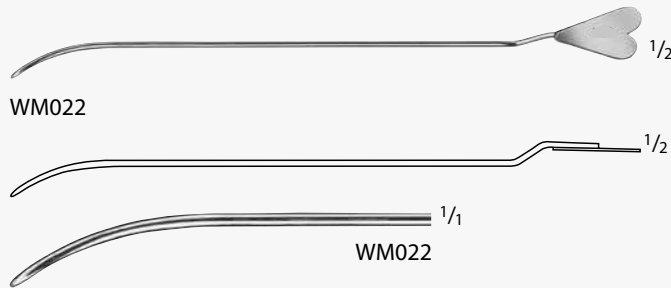
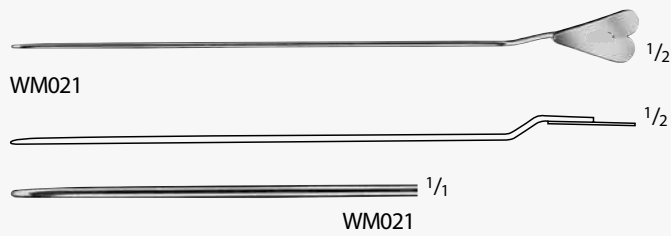

LOCKHART-MUMMERY Fistula Probe

Catalog Number	Blade Shape	Length (in.)
WM021	#1-STR	6 1/2
WM022	#2-SLT-CVD	6 1/2
WM023	#3-CVD	6 1/2
WM024	#4-HVY-CVD	6 1/2

WM168 -WM169



**BUIE Fistula Probe**

Catalog Number	Description	Length (in.)
WM168	LIGHT	6 1/2
WM169	HEAVY	6 1/2

WM034 -WM040 , WM603



**Probe W/ Eye**

Catalog Number	Tip Size (mm)	Length (in.)
WM603	1.5	5
WM034	2.5	5 3/4
WM036	2.5	6 1/4
WM040	3	7 7/8

WM571



**Probe W/ Eye, Silver**

Catalog Number	Tip Size (mm)	Length (in.)
WM571	1.75	4 1/2

WM054



WM063 -WM070



**Myrtle Leaf Probe**

Catalog Number	Tip Size (mm)	Length (in.)
WM054	1.5	5 3/4
WM063	2	5 1/8
WM064	2	5 3/4
WM066	2	6 1/4
WM068	2	7
WM070	2	7 7/8

INCHES





Double Ended Probe

Catalog Number	Tip Size (mm)	Length (in.)
WM104	1.0	5 3/4
WM113	1.5	5 1/8
WM114	1.5	5 3/4
WM116	1.5	6 1/4
WM118	1.5	7
WM120	1.5	7 7/8
WM125	1.5	9 3/4
WM134	2.0	5 3/4
WM136	2.0	6 1/4
WM138	2.0	7
WM140	2.0	7 7/8
WM150	2.0	11 3/4



Double Ended Probe W/ Eye, Malleable

Catalog Number	Tip Size (mm)	Length (in.)
WM090	3.0	7 1/2
WM095	3.5	9 3/4
WM096	3.5	11 3/4



PRATT Rectal Probe, Malleable

Catalog Number	Tip Size (mm)	Length (in.)
WM486	2.0	10

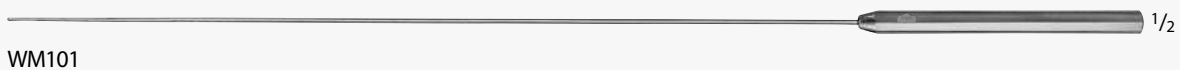

Probe

Catalog Number	Tip Size (mm)	Length (in.)
WM101	2.0	11 3/4



WM697 -WM699

DP697C -DP699C

FERGUSSON Gall Stone Scoop, Double Ended

Catalog Number	Size	Length (in.)
WM697	SMALL	9 1/2
WM698	MEDIUM	9 1/2
WM699	LARGE	9 1/2



WM170

BARR Fistula Probe, Double Ended

Catalog Number	Length (in.)
WM170	6 5/8



WM890

PRATT Fistula Probe, Crypt Hook

Catalog Number	Length (in.)
WM890	9 1/2

INCHES

1

2

3

4

5

6

7

8

9

10

11

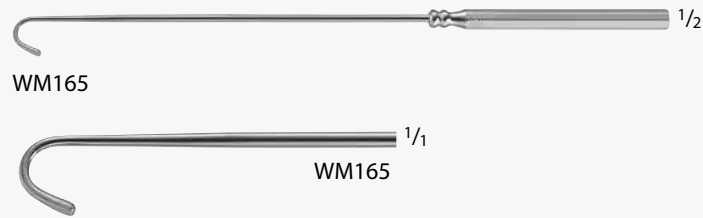

WM165

WM165

ROSSER Crypt Hook

Catalog Number	Length (in.)
WM165	6 5/8

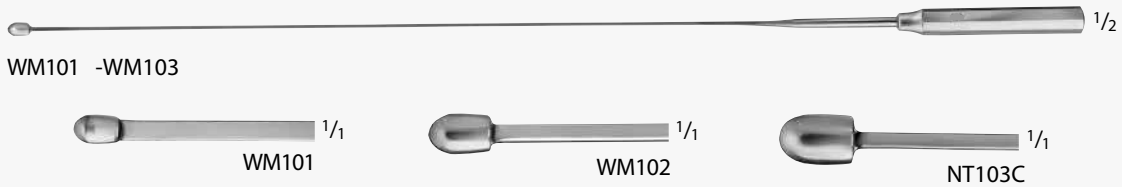

WM101 -WM103

WM101

WM102

NT103C

DESJARDINS Gall Duct Probe, Flexible

Catalog Number	Tip Size (mm)	Length (in.)
WM101	3.8	11 1/4
WM102	4.3	11 1/4
WM103	6.8	11 1/4

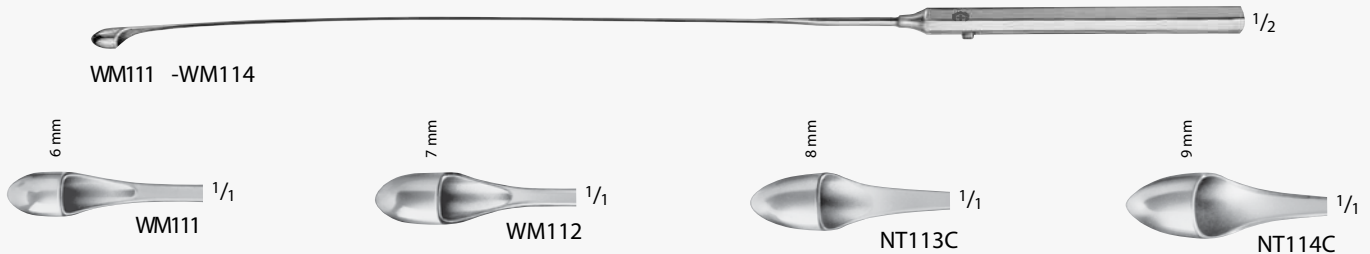

WM111 -WM114

6 mm

WM111

7 mm

WM112

8 mm

NT113C

9 mm

NT114C

DESJARDINS Gall Stone Scoop

Catalog Number	Tip Size (mm)	Length (in.)
WM111	6	11 3/4
WM112	7	11 3/4
WM113	8	11 3/4
WM114	9	11 3/4



WM005

MAYO Gall Duct Probe

Catalog Number	Tip Size (mm)	Tip	Length (in.)

INCHES

1

2

3

4

5

6

7

8

9

10

11

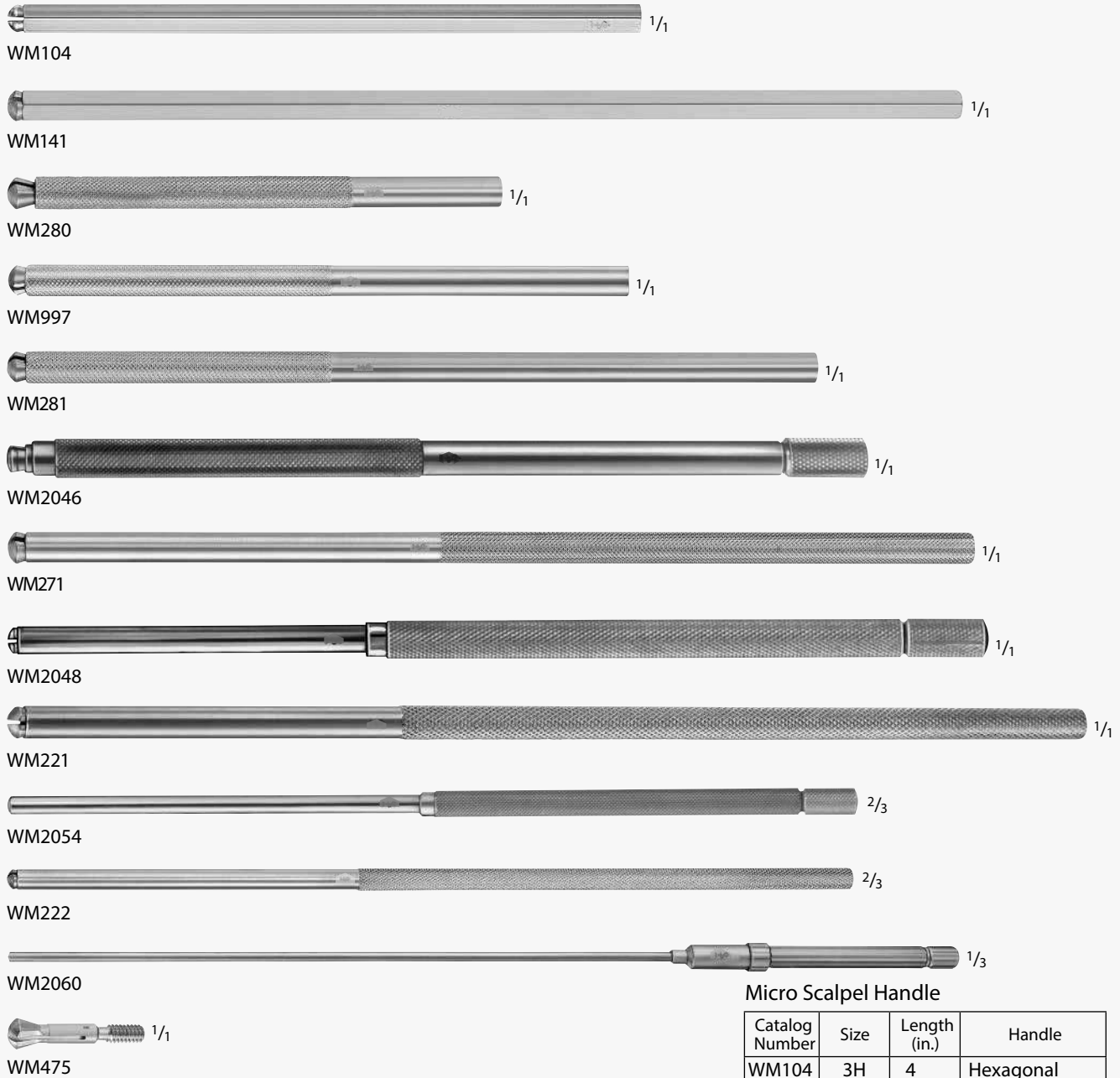

Micro Scalpel Handle

Catalog Number	Size	Length (in.)	Handle
WM104	3H	4	Hexagonal
WM141	3HL	6	Hexagonal
WM280	3KM	3	Cound Knurled
WM997	3K	4	Cound Knurled
WM281	3KD	5	Cound Knurled
WM2046	3K	5 1/4	Cound Knurled
WM271	3KL	6	Cound Knurled
WM048	3KL	6 1/8	Cound Knurled
WM475	COLLET		

WM475  
Replacement collet for WM104C ,WM141 , WM279 , WM280 ,WM281 and WM997

WM203



CORWIN Knife Handle

Catalog Number	Length (in.)
WM203	5 1/2

WM2052

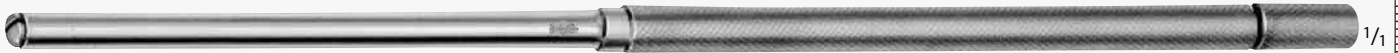

CASPAR Scalpel Handle

Catalog Number	Length (in.)
WM2052	7

WM2053



WM2053

WM2057



LANDOLT Scalpel Handle,  
F/ Microsurgery Blades

Catalog Number	Length (in.)
WM2053	8 1/4
WM2057	9 3/4



WM2331



WM2332

YASARGIL Arachnoid Blades  
F/ LANDOLT Scalpel Handles

Catalog Number	Tip Size (mm)	Packaging
WM2331	1.5	10/BOX
WM2332	2.5	10/BOX



Transsphenooidal Scalpel Handle,  
Bayonet, F/ Vertical and Lateral Blades

Catalog Number	Length (in.)
WM2071	8 1/4



WM2361



WM2362



WM2363



WM2364



WM2365



WM2367



WM2368

Sterile Microsurgery Blades

Catalog Number	Tip	Packaging
WM236	SMALL CHISEL #61	10/BOX
WM2362	WIDE CHISEL #62	10/BOX
WM2363	SPEAR #63	1 EACH
WM2364	ROUND#64	10/BOX
WM2365	SMALL, SHARP #65	10/BOX
WM2367	CURVED, POINTED#67	10/BOX
WM368	SMALL SICKLE #68	10/BOX



WM2068

BARRON Scalpel Handle #3 F/ Blades  
nos. 10-15, 40, 42

Catalog Number	Length (in.)
WM2068	5 1/8



WM2070

Scalpel Handle #3, F/ Blades  
nos. 10-15, 40, 42

Catalog Number	Length (in.)
WM2070	6 1/8

INCHES



WM2074

1 1/4



WM2075

2 2/3



WM2175

1 1/2



WM917

1 1/3

Scalpel Handle #3, F/ Blades  
nos. 10-15, 40, 42

Catalog Number	Size	Length (in.)
WM2074	#3	5
WM2075	#3L	8 1/4
WM2175	#3XL	9 3/4
WM917	#3	16



WM127

2 2/3

Scalpel Handle #3L, F/ Blades  
nos. 10-15, 40, 42

Catalog Number	Blade Shape	Length (in.)
WM127	ANG	8



WM2078

1 1/2

Scalpel X-Long Handle, #3, F/ Blades  
nos. 10-15, 40, 42

Catalog Number	Blade Shape	Length (in.)
WM2078	STR	8 7/8

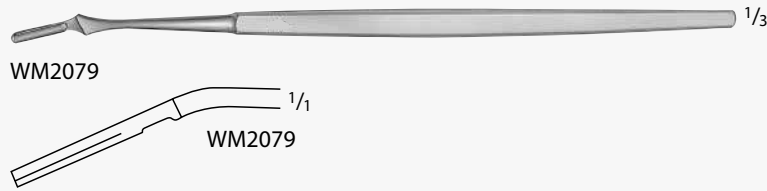

Scalpel X-Long Handle, #3, F/ Blades nos. 10-15, 40, 42

Catalog Number	Blade Shape	Length (in.)
WM2079	ANG	8 7/8



Scalpel Handle #4, F/ Blade nos. 18-36

Catalog Number	Length (in.)
WM2080	8 7/8



Scalpel Handle #4, F/ Blades nos. 18-36

Catalog Number	Length (in.)
WM2084	5 1/4



Scalpel Handle #4L, F/ Blades nos. 18-36

Catalog Number	Length (in.)
WM2085	8 1/2

INCHES

WWW.WYZZMEDICAL.COM



WM2087

Scalpel Handle #4XL, F/ Blades  
nos. 18-36

Catalog Number	Length (in.)
WM2087	9 3/4



WM2077

Scalpel Handle #7, F/ Blades  
nos. 10-15, 40, 42

Catalog Number	Length (in.)
WM2077	6 1/4



WM202



WM089

Scalpel Handle #9XL, F/ Blades  
nos. 18-36

Catalog Number	Length (in.)
WM202	4 5/8
WM089	5 3/4

INCHES



INCHES



WM2510, 16600495



WM2515, 16600525



WM2511, 16600509



WM2540 double cutting



C2512, 16600517

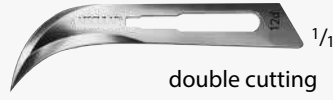

WM2542

Sterile Scalpel Blade, For #3 Handle

Catalog Number		Blade Number	Packaging
Carbon	Stainless Steel		
C2510	16600495	#10	100/BOX
C2511	16600509	#11	100/BOX
C2512	16600517	#12	100/BOX
C2515	16600525	#15	100/BOX
C2540	-	#40	100/BOX
C2542	-	#42	100/BOX



WM2520, 16600550



WM2521, 16600568



WM2522, 16600576



WM2523, 16600584



WM2524, 16600592



WM2525, 16616634



WM2536, 16615522

Sterile Scalpel Blade, For #4 Handle

Catalog Number		Number	Packaging
Carbon	Stainless Steel		
WM2520	16600550	#20	100/BOX
WM2521	16600568	#21	100/BOX
WM2522	16600576	#22	100/BOX
WM2523	16600584	#23	100/BOX
WM2524	16600592	#24	100/BOX
WM2525	16616634	#25	100/BOX
WM2536	16615522	#36	100/BOX



WM2500, 16600487

Sterile Stitch Cutter Blade #3 Handle

Catalog Number		Packaging
Carbon	Stainless Steel	
C2500	16600487	100/BOX



WWW.WYZZMEDICAL.COM

Sterile Scalpels W/ Plastic Handle and Blade Protector

Catalog Number		Size	Packaging
Carbon	Stainless Steel		
WM210	5518059	10	10/BOX
WM211	5518040	11	10/BOX
WM212	5518105	12	10/BOX
WM215	5518032	15	10/BOX
WM218	-	18	10/BOX
WM219	-	19	10/BOX
WM220	5518067	20	10/BOX
WM221	5518075	21	10/BOX
WM222	5518083	22	10/BOX
WM223	5518016	23	10/BOX
WM224	5518091	24	10/BOX



WM100 -WM103

LISTON Amputating Knife

Catalog Number	Blade Length (mm)	Blade Size (in.)
WM100	130	6 1/4
WM101	160	5 1/8
WM102	190	7 1/2
WM103	220	8 3/4



WM116

CATLIN Amputating Knife, Double Cutting

Catalog Number	Blade Length (mm)	Blade Size (in.)
WM116	160	6 1/4

INCHES

1  
2  
3  
4  
5  
6  
7  
8  
9  
10  
11

WWW.WYZZMEDICAL.COM



WM300



WM301 -WM302

CHARRIÈRE Amputation Saw, 2 Blades

Catalog Number	Item	Blade Size (in.)	Blade Width (mm)	Total Length (in.)
WM300	SAW COMPLETE W/2 BLADES	8 1/2	-	14
WM301	CARBON STEEL BLADE	8 1/2	12	-
WM302	CARBON STEEL BLADE	8 1/2	18	-



WM320

CHARRIÈRE Amputation Saw

Catalog Number	Item	Blade Size (in.)	Total Length (in.)
WM320	SAW COMPLETE	7 1/4	10 1/2



WM325 -WM326

SATTERLEE Amputation Saw

Catalog Number	Item	Total Length (in.)
WM325	SAW COMPLETE	11 1/2
WM326	CARBON STEEL BLADE F/ TS325C	-



WM335

LANGENBECK Metacarpal Saw

Catalog Number	Length (in.)
WM335	9 1/4

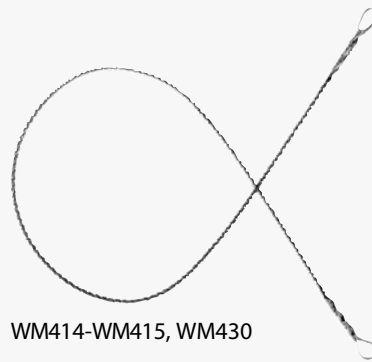

WM414-WM415, WM430



WM414-WM415, WM430

GIGLI Wire Saw

Catalog Number	Diameter (mm)	Wires	Sales Unit	Length (in.)
WM414	1.4	6	BOX OF 5	15 3/4
WM415	1.4	6	BOX OF 5	19 3/4
WM430	1.8	4	BOX OF 5	19 3/4



WM986

GIGLI Saw Handle

Catalog Number	Packaging
WM986	2/SET



WM480

GIGLI Hook Handle, F/ Wire Saws

Catalog Number	Packaging
WM480	2/SET

INCHES



WWW.WYZZMEDICAL.COM

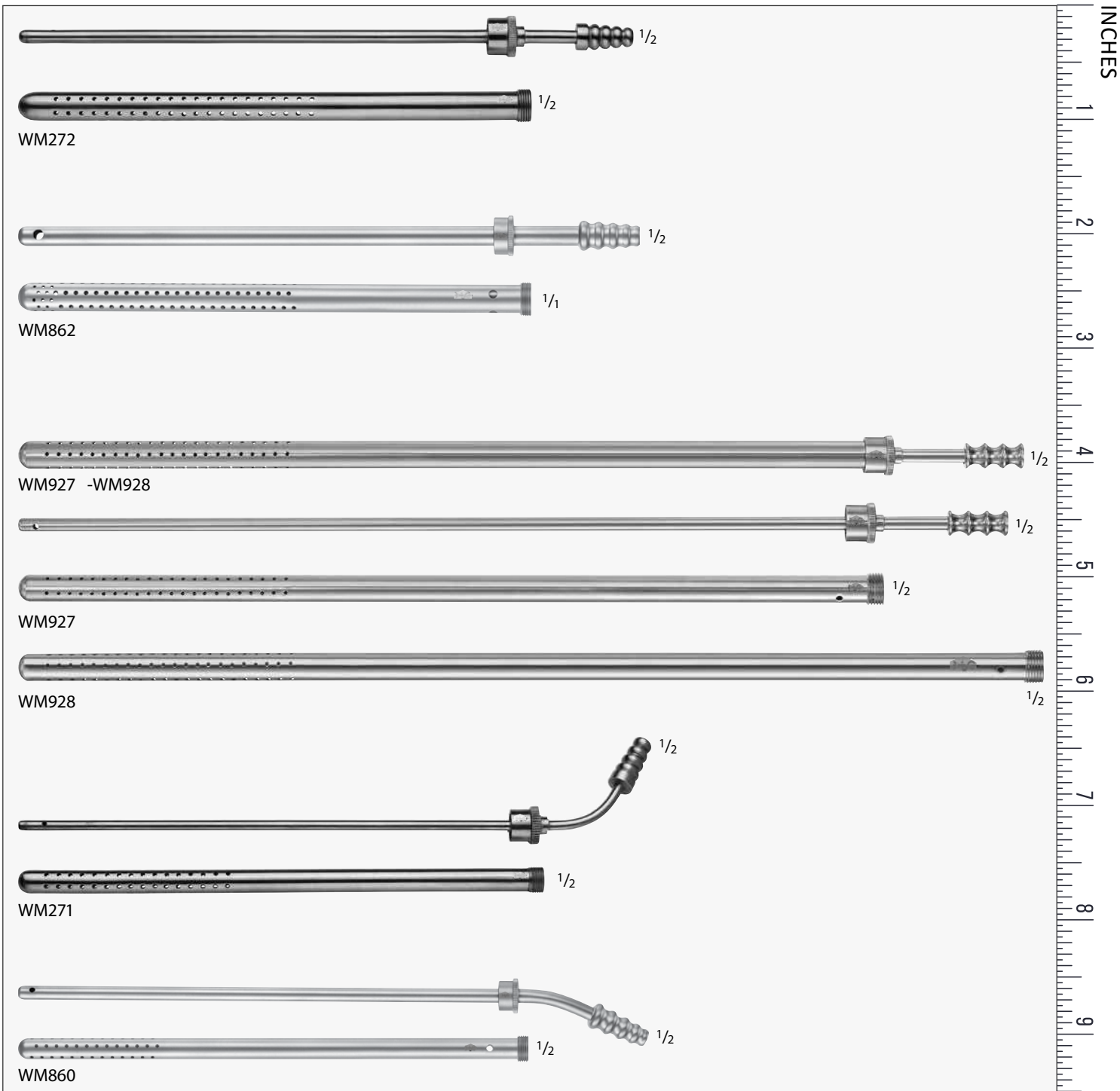

POOLE Suction Tube

Catalog Number	Handle	Tip Size (FR)	Hole in Tip Inner/Outer	Tube Diameter Inner/Outer	Length (in.)
WM272	STR	30	YES/YES	5 mm/10 mm	8 1/2
WM862	STR	30	YES/NO	5 mm/10 mm	8 7/8
WM927	STR	30	YES/YES	4 mm/10 mm	14
WM928	STR	30	YES/YES	4 mm/10 mm	16
WM271	CVD	24	YES/NO	4 mm/8 mm	8 3/4
WM860	CVD	21	YES/YES	4 mm/8 mm	8 7/8

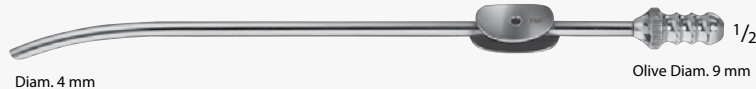

Diam. 4 mm

Olive Diam. 9 mm

WM917

### ADSON Suction Tube

Catalog Number	Tip Size (mm)	Tip Size (FR)	Length (in.)
WM917	4	11	7 1/2



Olive Diam. 6 - 9 mm

WM919

### Nasal Suction Tube W/ Luer Hub, Tapered

Catalog Number	Tip Size (mm)	Length (in.)
WM919	5	7



Diam. 8 mm Outer Tube

Olive Diam. 9 - 11 mm

WM821

### COOLEY Suction Tube

Catalog Number	Tip Size (mm)	Length (in.)
WM821	8.0	13 1/4



WM822



WM823



WM824

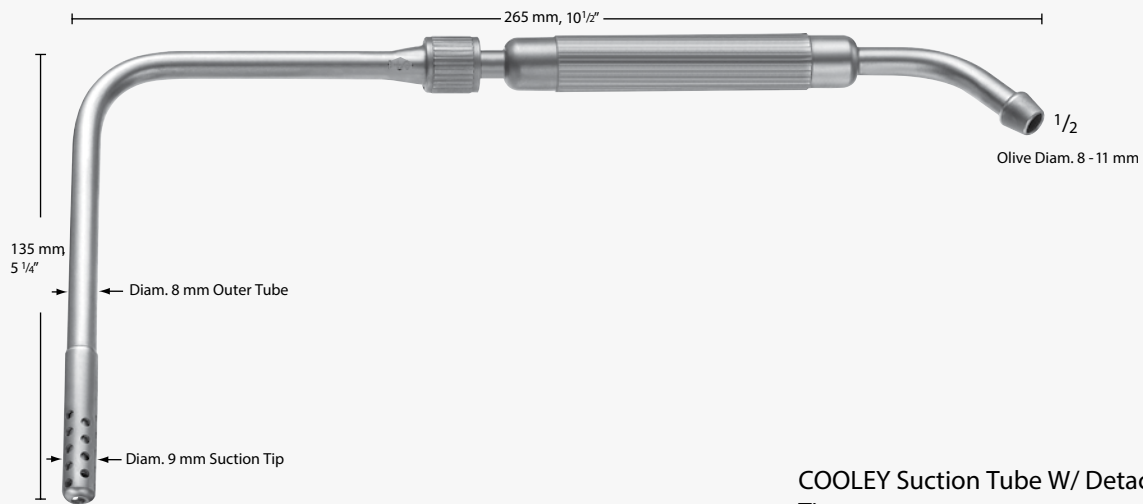

WM825

COOLEY Suction Tube W/ Detachable Tip

Catalog Number	Tip Size (mm)	Shaft	Length (in.)
WM822	8.0	SLT-CVD	12 1/4
WM823	9.0	CVD	11 5/8
WM824	8.0	ANG	12 1/2
WM825	9.0	90°	10 1/2





WM286 -WM287

### Grafting Suction Tube

Catalog Number	Tip Size (mm)	Length (in.)
WM286	3	9 1/2
WM287	4	9 1/2



WM946

Diam. 9 mm



WM946



WM947

Diam. 5 mm



WM947

Olive Diam. 9 mm



WM948

Diam. 5 mm



WM948

Olive Diam. 9 mm

### DEBAKEY Suction Tube

Catalog Number	Tip Size (mm)	Length (in.)
WM946	3	10 3/4
WM947	5	6 1/4
WM948	5	10 5/8
WM946205	REPLACEMENT TIP FOR TL946C	-

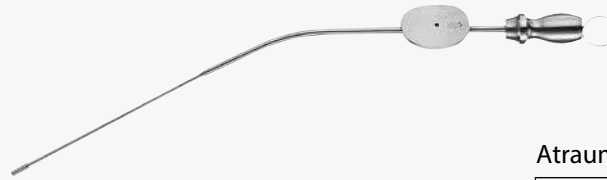

WM333 -WM347

Atraumatic Suction Tube

Catalog Number	Tip Size (FR)	Working Length (in.)	Length (in.)
WM336	10	3	6 1/4
WM337	12	3	6 1/4
WM341	10	4	7 1/4
WM342	12	4	7 1/4
WM346	10	5	8 1/4
WM347	12	5	8 1/4

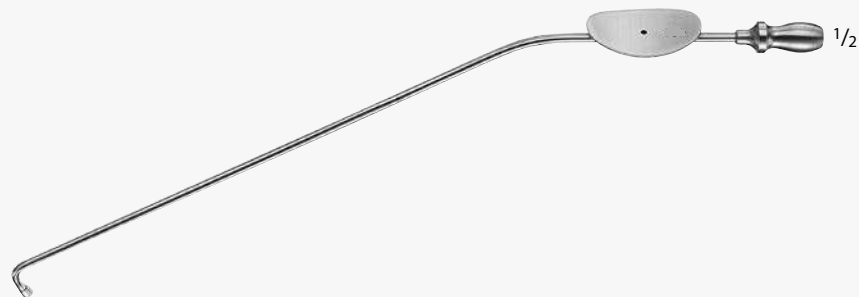

WM106 -WM111



WM106 -WM108



WM109 -WM111

Atraumatic Suction Tube

Catalog Number	Tip	Tip Size (FR)	Length (in.)
WM106	90° DOWN	5	8 1/2
WM107	90° DOWN	7	8 1/2
WM108	90° DOWN	10	8 1/2
WM109	90° UP	5	8 1/2
WM110	90° UP	7	8 1/2
WM111	90° UP	10	8 1/2



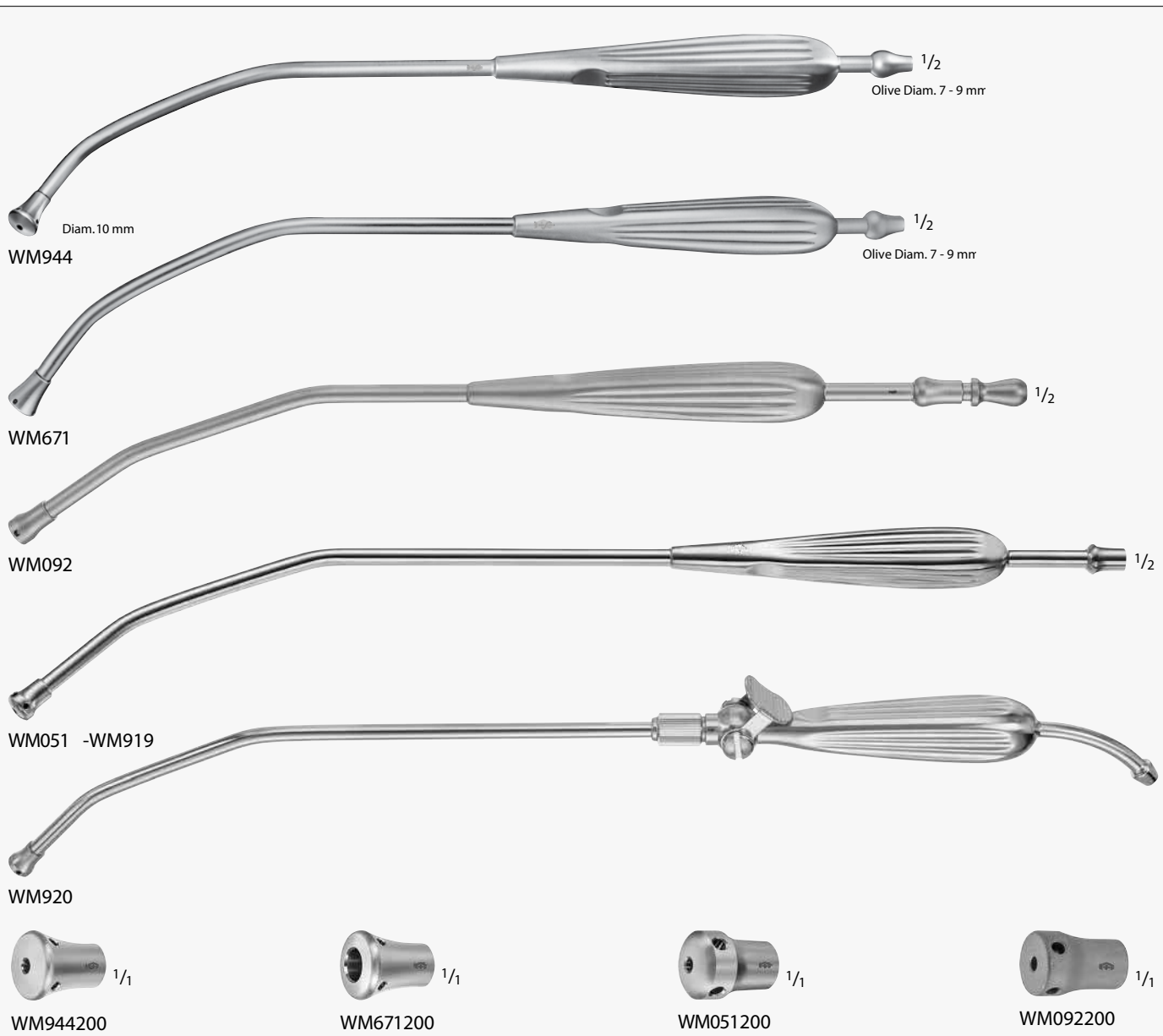

YANKAUER Suction Tube

Catalog Number	Description	Tip Opening (mm)	Length (in.)
WM944	-	2.0	11 1/4
WM671	-	4.8	11 1/4
WM919	-	2.0	12
WM092	W/ VALVE	2.0	13 1/4
WM051	-	2.0	14
WM920	W/ VALVE	2.0	16
WM944200	REPLACEMENT TIP F/ TL944C	-	-
WM671200	REPLACEMENT TIP F/ OM671C	-	-
WM051200	REPLACEMENT TIP F/ DP051C , DP053C , AO919C , AO920C	-	-
WM092200	REPLACEMENT TIP F/ AO092C	-	-



YANKAUER Suction W/ Thumb Control

Catalog Number	Description	Length (in.)
WM052	HANDLE W/ THUMB CONTROL	6 7/8
WM053	SUCTION TUBE, CHROME PLATED	6 5/8



FERGUSSON Suction Tube

Catalog Number	Tip	Tip Size (mm)	Length (in.)
WM933	ROUND	4	7

INCHES

1  
2  
3  
4  
5  
6  
7  
8  
9  
10  
11

### FERGUSSON Suction Tube, Luer Hub

Catalog Number	Diameter (mm)	Working Length (in.)	Length (in.)
WM350	1.5	4 1/4	7 3/4
WM351	2.0	4 1/4	7 3/4
WM352	2.5	4 1/4	7 3/4
WM353	3.0	4 1/4	7 3/4
WM354	4.0	4 1/4	7 3/4
WM355	5.0	4 1/4	7 3/4
WM360	1.5	5 1/8	8 1/2
WM361	2.0	5 1/8	8 1/2
WM362	2.5	5 1/8	8 1/2
WM363	3.0	5 1/8	8 1/2
WM364	4.0	5 1/8	8 1/2
WM365	5.0	5 1/8	8 1/2
WM370	1.5	6 1/4	9 5/8
WM371	2.0	6 1/4	9 5/8
WM372	2.5	6 1/4	9 5/8
WM373	3.0	6 1/4	9 5/8
WM374	4.0	6 1/4	9 5/8
WM375	5.0	6 1/4	9 5/8
WM380	1.5	7 7/8	11
WM381	2.0	7 7/8	11
WM382	2.5	7 7/8	11
WM383	3.0	7 7/8	11
WM384	4.0	7 7/8	11
WM385	5.0	7 7/8	11

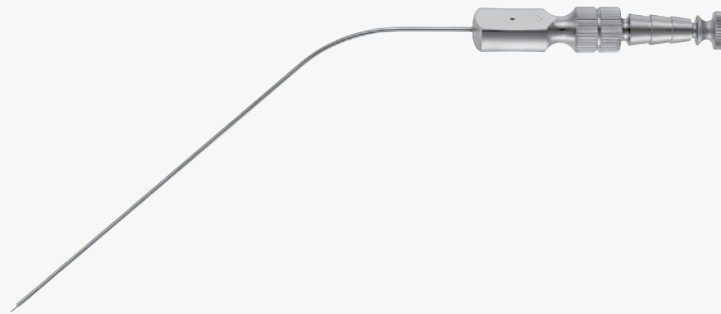

WM350 -WM385



### FRAZIER Suction Tube

Catalog Number	Tip Size (FR)	Description	Working Length (in.)
WM124	7		4 1/4
WM124300	7	SUCTION STYLET W/ OLIVE TIP FOR AP124C	
WM125	7		4 1/4
WM125300	8	SUCTION STYLET W/ OLIVE TIP FOR AP125C	
WM501	9		4 1/4
WM 501300		SUCTION STYLET W/ OLIVE TIP FOR SE501C	
WM127	10		4 1/4
WM127300	10	SUCTION STYLET W/ OLIVE TIP FOR AP127C	
WM499	11		4 1/4
WM499300	11	SUCTION STYLET W/ OLIVE TIP FOR SE499C	
WM129	12		4 1/4
WM129300	12	SUCTION STYLET W/ OLIVE TIP FOR AP129C	

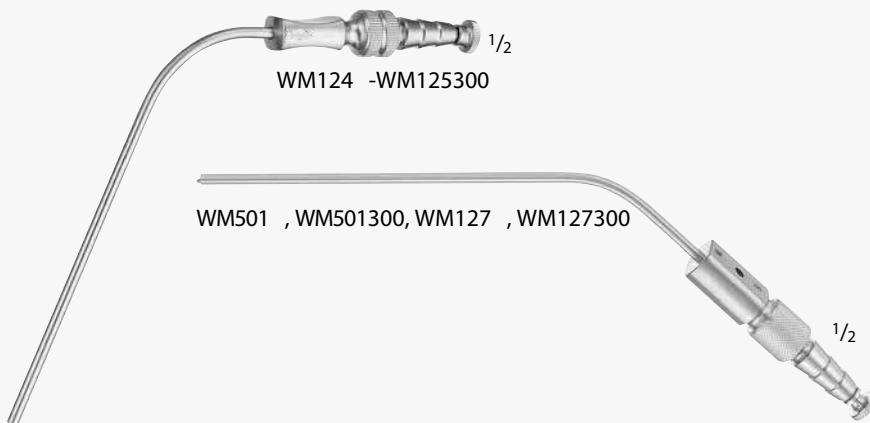

WM124 -WM125300

WM501 , WM501300, WM127 , WM127300



WM501300



WM499 , WM499300, WM129 , WM129300



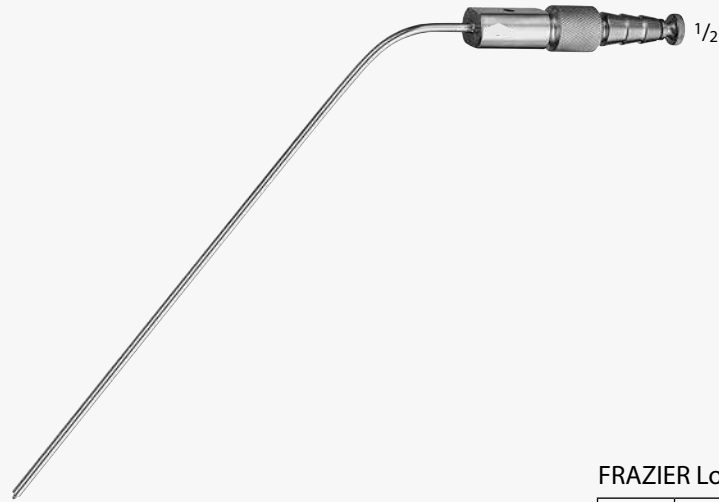

WM091-WM099

### FRAZIER Long-Suction Tube

Catalog Number	Tip Size (FR)	Length (in.)
WM091	3	6 1/2
WM092	5	6 1/2
WM093	6	6 1/2
WM094	7	6 1/2
WM095	8	6 1/2
WM096	9	6 1/2
WM097	10	6 1/2
WM098	11	6 1/2
WM099	12	6 1/2



Olive Diam. 6 - 9 mm

WM923 -WM925

### FRAZIER Suction Tube W/ Luer Hub

Catalog Number	Tip Size (FR)	Length (in.)
WM923	9	7
WM925	15	7





WM980

### LANDOLT Dissecting Suction Tube

Catalog Number	Tip	Tip Size (mm)	Length (in.)
WM980	ANG, SHARP	3.2	7 7/8



WM635 -WM636

### SACHS Suction Tube

Catalog Number	Tip Size	Length (in.)
WM635	SMALL	8 1/2
WM636	LARGE	8 1/2



WM106-WM107

### PRIBRAM Suction Tube with Thumb Control

Catalog Number	Tip	Length (in.)
WM106	16	5 1/2
WM107	18	5 1/2



WM100 -WM110

### OCHSNER Trocar

Catalog Number	Tip Size (FR)	Length (in.)
WM100	10	6
WM101	12	6
WM102	14	6
WM103	16	6
WM104	18	6
WM105	20	6
WM106	22	6
WM107	24	6
WM108	26	6
WM109	27	6
WM110	28	6

INCHES



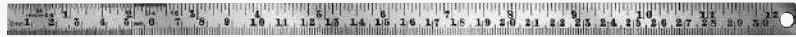

WM804 -WM806

Steel Ruler, Graduated In Millimeters and Inches

Catalog Number	Length (in.)
WM804	6
WM805	11 3/4
WM806	19 3/4

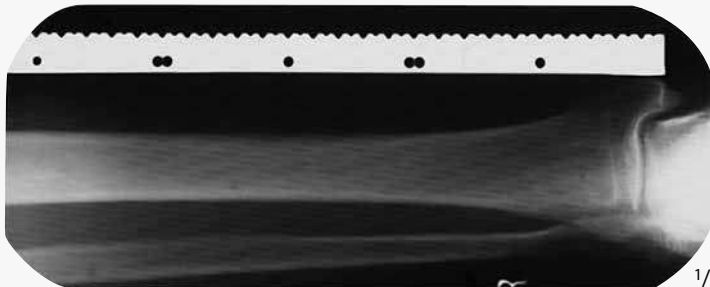

WM808

Ruler, F/ X-Ray Work

Catalog Number	Length (in.)
WM808	19 3/4

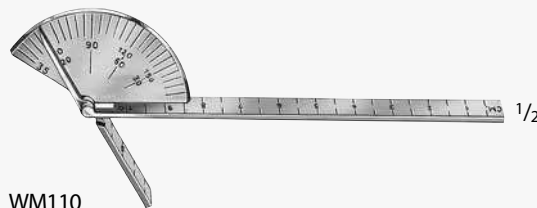

WM110

Finger-Goniometer

Catalog Number
WM110



WM001 -WM004

### Surgical Spoon

Catalog Number	Size	Blade Size (mm)	Length (in.)
WM003	SMALL	25	4 1/4
WM002	MEDIUM	30	5 1/4
WM004	MEDIUM-LARGE	35	6 1/4
WM001	LARGE	40	7 1/2



783101-783102

### Staple Remover

Catalog Number	Description
783102	REUSABLE
783101	SINGLE USE (BOX OF 6)



WM77 -WM378

### TAYLOR Percussion Hammer

Catalog Number	Size	Length (in.)
WM377	SMALL	7
WM378	LARGE	7 3/4

INCHES





Metal Sponge Bowl

Catalog Number	Capacity (qts.)
WM061	1
WM060	1 1/2
WM062	1 7/8



Metal Cup

Catalog Number	Item	Capacity (oz.)
WM066	MEDICINE CUP	2
WM063	IODINE CUP	6
WM067	SOLUTION BASIN	12
WM065	IODINE CUP	14
WM064	GRADUATED MEASURE	32



Kidney Tray

Catalog Number	Length (in.)
WM504	6 3/4
WM506	9 3/4

INCHES

1  
2  
3  
4  
5  
6  
7  
8  
9  
10  
11



# WYZZ MEDICAL

Meet our Wyzz Medical general surgery product line. A series of high quality reusable surgical instrument crafted with great care

## CONTACT US

+31 85 0477700



[www.wyzzmedical.com](http://www.wyzzmedical.com)



Vlissingen, The Netherlands

